



**OMSER**  
(SCOTLAND) LTD.

incorporating  
**TOUCH PRINT**  
THE SIGN AND LABELLING SPECIALISTS



 **BRADY**

# LABORATORY IDENTIFICATION

**Labels, printers & software for laboratories**

# About **BRADY**



**Once you have worked with BRADY, our name will stick with you, (just like our labels) because BRADY is one of the world's leading labelling and identification specialists.**

## **Innovative**

At BRADY we continue to improve. We have many customers from all industries, and we strive to be ahead of their needs by continuing to invest in research for even more performant solutions. By developing more user-friendly and efficient concepts, we give our thousands of customers the best in the market.

## **Strength**

At BRADY, we believe our biggest strength is the wide range of identification and safety solutions we can offer our customers, whether it's labelling the smallest component or complete signage for an entire warehouse. We're also proud to offer many products and services - from printers, scanners and software to service contracts and on-site training - that compliment any identification job. And don't forget, our wide network of expert distributors can always offer you a tailor-made solution to meet your specific requirements.

## **Trust**

For over a hundred years, BRADY has been connected with quality, trust and stability. We demand the best for your products and services, because we know, better than anyone, the importance of good and reliable identification. Identification looks like a small detail, but every professional knows that this kind of detail is crucial to any business.

## **Inform**

We also have specialised dealers in your region, who can answer all your identification, safety and labelling questions, specific to your activity. They will be happy to provide you with all kinds of options and solutions with no obligation.

Microsoft is a trademark of Microsoft Corporation, Bluetooth is a trademark of Bluetooth Sig, Inc., Android is a trademark of Google Inc.



Brady products are sold on the condition that the purchaser will test them in actual use and determine for himself/herself their suitability to his/her intended purpose. Brady warrants to the purchaser that Brady products are free from defects in material and workmanship but limits its obligation under this warranty to the replacement of the product which has been shown to Brady's satisfaction to have been defective at the time of its purchase.

The warranty does not extend to any persons who have acquired the product from the purchaser. It is in lieu of any other warranty, including every warranty of sale-ability, marketability or suitability for the intended purpose, and is also in lieu of any other obligation or liability on the part of Brady.

Under no circumstances will Brady be liable for losses, damage, costs or subsequent damage of whatever nature which may arise in connection with the use of, or inability to use, Brady's products.

# Laboratory Identification

## Labels, printers & software for the laboratory

### The Brady Advantage

When it comes to identification, safety and compliance, there's a clear advantage to working with Brady. We put our customers first in everything we do.

Our goal is to give you an unrivalled customer experience. We are relentlessly committed to performance and excellence - in our products, services and people.

Our products and solutions perform in ways that others simply can't match. Our people perform in ways that regularly exceed your expectations, and our focus and discipline work toward solid, long-term performance for our customers.

In short, Brady is the company you trust when performance matters most.

**Learn more about the Brady Advantage at: [www.bradyeurope.com](http://www.bradyeurope.com)**

### Table of Content

4 Simplify Your Laboratory Identification

#### Laboratory Identification Labels

6 Choose your Application

7 Thermal transfer print ribbons

11 Vial / Tube Labels

17 Vial top labels

21 Centrifuge, Eppendorf and PCR Labels

26 Cryo Tubes & Vials

31 Conical / Large Tube Labels

38 Slide Labels

40 Straw and Rod Labels

41 Well Plate Labels

45 Bottles / Flasks & Dishes

49 General Lab ID

#### Label Printers and Barcode Scanners

54 Choose Your Printer

58 M210-LAB Label Printer

59 M211 Label Printer

60 M511 Label Printer

61 M510 Label Printer

62 M610 Label Printer

63 M611 Label Printer

64 M710 Label Printer

65 BBP12 Label Printer

66 BradyPrinter i3300 Industrial Label Printer

67 BradyPrinter i5100 Industrial Label Printer

68 BradyPrinter i5300 Industrial Label Printer

69 BradyPrinter i7100 Industrial Label Printer

71 BradyJet™ J7300 Colour Label Printer

72 BradyJet™ J4000 Colour Label Printer

73 Label Creation Software

74 Barcode readers for Laboratories

#### Miscellaneous Products

80 Hazardous Substance Identification

83 Sorbent Products



## Simplify Your Laboratory Identification

Brady's laboratory identification products are designed to serve the world's biotechnology, agricultural, environmental and forensic researchers. Whether you work in pathology, histology, chromatography or other areas of science, Brady labelling solutions can help you maintain Good Laboratory Practice.

### Brady Sample Identification solutions:

- match existing vial, slide, and well plate sizes
- remain legible throughout processing and storage
- endure freezer storage, liquid nitrogen, autoclave, hot water baths and solvents including Xylene, DMSO and Ethanol
- allow bar coding for extensive information storage on even the tiniest sample
- integrate seamlessly with your Laboratory Information Management System (LIMS)

### Hand-written versus printed labels

Did you ever have to postpone research because of unidentified samples, or because nobody was able to read anymore what was once written on the sample you need? Printed laboratory labels, engineered specifically to identify samples, help avoid sample loss and a lot of frustration.



#### Hand-Written Information

- Is difficult to read
- Smears when handled
- Has limited communication potential
- Fades over time when stored
- Is erased by chemicals

#### Brady Printed Laboratory Labels

- Are crisp, clear and readable
- Do not smear nor fade
- Can hold much information
- Have increased durability
- Resist chemicals

### Lab-durable labels

Brady's special self-laminating or wrap around label protects your label's legend from extreme temperature, chemicals and solvents.

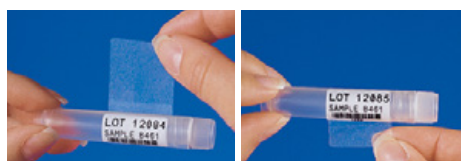

*For best adhesion, we recommend that you do not touch the adhesive side of the label when wrapping it around your vial or tube.*

- Printing is readable every time
- Clear portion wraps around and laminates the legend
- Provides window to view liquid level inside vial
- Low profile (extremely thin) label resists jamming in centrifuge or racks
- Labels withstand liquid nitrogen (-196°C), freezer (-80°C), autoclave (+121°C) and chemicals like Xylene



### On-site Label Creation

Brady printers enable professionals to print highly specialised identification labels on-site and on demand. Partnered with customisable software and a specific application system for laboratories, adaptable to specific processes or data file formats, Brady printers support considerable time savings and flexibility in sample identification.

Every Brady identification label can be printed on-site using a Brady mobile or benchtop printer. See page 54 for the full range of label printers.



## Laboratory Identification Labels

Extensive material knowledge combined with chemical expertise enables Brady to develop durable labels that perform throughout sample storage and processing.

- 6 Choose your Application
- 7 Thermal transfer print ribbons
- 11 Vial / Tube Labels
- 17 Vial top labels
- 21 Centrifuge, Eppendorf and PCR Labels
- 26 Cryo Tubes & Vials
- 31 Conical / Large Tube Labels
- 38 Slide Labels
- 40 Straw and Rod Labels
- 41 Well Plate Labels
- 45 Bottles / Flasks & Dishes
- 49 General Lab ID

### ▶ Part number explanation

Most Brady references for printable labels follow the same three-part format: The first code indicates the technology, the second part is a number indicating the label size (where applicable) and the third part indicates the Brady material (where applicable).

**M7-73-461**

M710 Technology	73 Label size code	461 Material (B-number)
--------------------	--------------------------	-------------------------------

# Choose your Application



Vial/Tube



Conicals/bottles



Slide



Straw

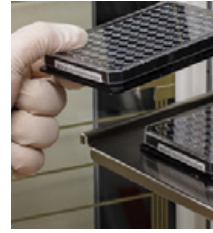

Well Plate



General Lab ID

Material	Printer Ribbon Series	Temp (°C) (Tested for 30 days)		APPLICATION						ENVIRONMENT			Low-Profile <small>(extremely thin)</small>	Additional Features	
				Vial/Tube	Conical / Large Tubes	Slide	Straw	Well Plate	General Lab ID	Freezer	Liquid Nitrogen	Autoclave (121°C)			Hot Water Bath (100°C)
<b>FreezerBondz™ Polyester</b>															
B-490	R4300	-196 °C	130 °C	✓	✓			✓	✓	✓	✓	✓	✓	✓	Can be applied to frozen surfaces including glass and polypropylene stored in liquid nitrogen, except for Vial Tops. Material must slightly overlap itself.
B-492	R6400	-196 °C	110 °C	✓	✓			✓	✓	✓	✓	✓	✓	✓	Ultra thin; can label frosted/frozen (with overlap) or room temperature labels and lasts in liquid nitrogen and hot water baths
<b>Nylon Cloth</b>															
B-499	R4300, R6000HF, R6200B, R7950	-196 °C	90 °C	✓	✓			✓	✓	✓	✓	✓			Permanent adhesion; write-on capabilities. Temperature range increases to 121°C when used in autoclave process. Tested 3 cycles of 1 hour in 121°C at 15 psi for autoclave process. Available in white or yellow.
<b>Paper</b>															
B-403	R4300	-70 °C	100 °C												White dissolvable paper. Dissolves completely in water leaving no adhesive residue, ideal for temporary labelling applications
B-424	R4300, R7950	-40 °C	50 °C					✓	✓						White paper material with matt finish and smooth top coat finish for thermal transfer printing. Good contrast and smear resistance for thermal barcode printing. Used for general purpose labeling applications
<b>Polyester</b>															
B-423	R4410, R6000HF	-70 °C	110 °C		✓			✓	✓	✓		✓	✓		Widely used for component identification, barcoding, asset and inventory tracking.
B-488	R4300, R7950	-40 °C	145 °C		✓	✓		✓	✓	✓		✓			White polyester thermal transfer printable material, similar to B-423, but with matt finish. Widely used for component identification, barcoding, asset and inventory tracking.
<b>Polypropylene</b>															
B-7425	R4300	-80 °C	70 °C	✓		✓		✓		✓	✓	✓	✓		White Polypropylene material. Ideal for laboratory identification such as vials, centrifuge tubes and test tubes. For freezer or liquid nitrogen applications, B-7425 must be applied prior to being frozen.
<b>Self-laminating Polyester</b>															
B-461	R4300, R7950	-196 °C	110 °C	✓	✓		✓			✓	✓	✓	✓	✓	Permanent adhesive; suitable for liquid nitrogen application if material is wrapped around itself, as in self-lamination; write-on capabilities. Temperature range increases to 121°C when used in autoclave process
<b>Self-laminating Vinyl</b>															
B-427	R4300	-40 °C	60 °C	✓	✓		✓			✓	✓				Permanent acrylic adhesive; self-laminating; write-on capabilities; suitable for liquid nitrogen application and can be used to identify a frozen vial if label material is wrapped around itself, as in self-lamination. Temperature range goes to -196°C if material is wrapped around vial and overlaps itself.
<b>StainerBondz™ Polyester</b>															
B-481	R6400	-80 °C	130 °C			✓				✓	✓		✓		White polyester will remain resistant when exposed to xylene and other chemicals that are commonly used in the slide staining process
<b>Vinyl</b>															
B-595	R4400, R6000HF, R6900	-40 °C	82 °C					✓	✓	✓					Durable, low-shrink vinyl with our most aggressive adhesive. Conforms to irregular, curved, rough and highly textured surfaces (painted cinder blocks, uneven wood, textured plastics, paper-jacketed pipes, powder-coated surfaces). Adheres to "difficult" low-surface energy items (PVC piping, blow-moulded equipment cases, ABS plastics, recycled plastics). Available in a wide range of colours.

# Thermal transfer print ribbons

## Thermal transfer print ribbons for M710, M610 and M611



Ribbon Series	Order Reference	Roll Width (mm)	Roll Length (m)	Formulation	Colour	Notes / Details
<b>M611, M610</b>						
R4300	M61-R4310	50.00	22.86	Wax/Resin	Black	M610 R4300 Series : chemical, environmental and smear resistant Black Ribbon
R4400	M61-R4410-WT	50.00	22.86	Resin	White	M610 R4400 Series : high heat, scratch and solvent resistant White Ribbon
R4400	M61-R4410-RD	50.00	22.86	Resin	Red	M610 R4400 Series : high heat, scratch and solvent resistant Red Ribbon
R4400	M61-R4410-BL	50.00	22.86	Resin	Blue	M610 R4400 Series : high heat, scratch and solvent resistant Blue Ribbon
R6000HF	M61-R6010	50.00	22.86	Resin	Black	M610 R6000 Series : high heat, scratch and solvent resistant Black Ribbon
R6200	M61-R6210	50.00	22.86	Resin	Black	M610 R6200 Series : chemical, heat, scratch and smear resistant Black Ribbon
R6400	M61-R6410	50.00	22.86	Resin	Black	M610 R6400 Series : abrasion and chemical resistant Black Ribbon
<b>M710</b>						
R6400	M7-R6400	50.00	45.72	Resin	Black	R6400 Series Resin Formulation offers superior chemical and abrasion resistance when printed on the appropriate label material from Brady®
R4300	M7-R4300	50.00	45.72	Wax/Resin	Black	Recommended for printing on paper and films that have a matte or rough surface, such as B-427 Self-Laminating Vinyl and B-499 Nylon Cloth from Brady
R6000HF	M7-R6000	50.00	45.72	Resin	Black	R6000 series ribbons' resin formulation offers a high-performance images with excellent solvent and scratch resistance
R6200	M7-R6200	50.00	45.72	Resin	Black	R6200 Series Ribbons offer superior scratch, smear, heat and chemical resistance when printed on the appropriate label material from Brady®

## Thermal transfer print ribbons for BBP12



Ribbon Series	Order Reference	Roll Width (mm)	Roll Length (m)	Formulation	Colour	Notes / Details
R4900	R4900-35X70/O	35.00	70.00	Resin	Black	This ribbon has superb smear resistance at high temperatures and superior solvent resistance.
R4900	R4900-65X70/O	65.00	70.00	Resin	Black	This ribbon has superb smear resistance at high temperatures and superior solvent resistance
R4900	R4900-85X70/O	85.00	70.00	Resin	Black	This ribbon has superb smear resistance at high temperatures and superior solvent resistance
R4900	R4900-110X70/O	110.00	70.00	Resin	Black	This ribbon has superb smear resistance at high temperatures and superior solvent resistance
R6000HF	R6000HF-65X70/O	65.00	70.00	Resin	Black	High density halogen free ribbon, excellent solvent resistance, high heat resistance, and super scratch resistance.
R6000HF	R6000HF-110X70/O	110.00	70.00	Resin	Black	High density halogen free ribbon, excellent solvent resistance, high heat resistance, and super scratch resistance.
R6200	R6213	102.00	74.00	Resin	Black	Designed for harsh environment labelling applications. Superior abrasion, chemical and heat resistance.
R6400	R6400-65X70/O	65.00	70.00	Resin	Black	Ultra high chemical resistance at high temperatures. Superior solvent resistance.
R6400	R6400-110X70/O	110.00	70.00	Resin	Black	Ultra high chemical resistance at high temperatures. Superior solvent resistance.
R7950	R7950-110X70/O	110.00	70.00	Wax/Resin	Black	Strong environmental resistance against smearing and chemicals. Also, reliable, sharp-edge print quality to maximise bar code readability.
R7950	R7950-35X70/O	35.00	70.00	Wax/Resin	Black	Strong environmental resistance against smearing and chemicals. Also, reliable, sharp-edge print quality to maximise bar code readability.
R7950	R7950-65X70/O	65.00	70.00	Wax/Resin	Black	Strong environmental resistance against smearing and chemicals. Also, reliable, sharp-edge print quality to maximise bar code readability.
R7950	R7950-85X70/O	85.00	70.00	Wax/Resin	Black	Strong environmental resistance against smearing and chemicals. Also, reliable, sharp-edge print quality to maximise bar code readability.
R7961	R7961-110X74/O	110.00	74.00	Resin	Black	R7961 ribbon, when printed on the appropriate Brady label, gives excellent scratch and good chemical resistance.

# Thermal transfer print ribbons

## Thermal transfer print ribbons for BradyPrinter i3300 and BradyPrinter i5300



Ribbon Series	Order Reference	Roll Width (mm)	Roll Length (m)	Formulation	Colour	Notes / Details
R4300	B30-R4300	110.00	60.00	Wax/Resin	Black	"Drop & Click" print ribbons for quick and easy supply changes. Ribbons are tough, smear-proof that produce long-lasting printed text. Print can withstand years in industrial areas and outdoor conditions.
R4400	B30-R4400-WT	110.00	60.00	Resin	White	"Drop & Click" print ribbons for quick and easy supply changes. Ribbons are tough, smear-proof that produce long-lasting printed text. Print can withstand years in industrial areas and outdoor conditions.
R6000HF	B30-R6000HF	110.00	60.00	Resin	Black	"Drop & Click" print ribbons for quick and easy supply changes. Ribbons are tough, smear-proof that produce long-lasting printed text. Print can withstand years in industrial areas and outdoor conditions.
R6200	B30-R6200	110.00	60.00	Resin	Black	"Drop & Click" print ribbons for quick and easy supply changes. Ribbons are tough, smear-proof that produce long-lasting printed text. Print can withstand years in industrial areas and outdoor conditions.
R6400	B30-R6400	110.00	60.00	Resin	Black	"Drop & Click" print ribbons for quick and easy supply changes. Ribbons are tough, smear-proof that produce long-lasting printed text. Print can withstand years in industrial areas and outdoor conditions.
R10000	B30-R10000	110.00	60.00	Resin	Black	"Drop & Click" print ribbons for quick and easy supply changes. Ribbons are tough, smear-proof that produce long-lasting printed text. Print can withstand years in industrial areas and outdoor conditions.
R10000	B30-R10000-BL	110.00	60.00	Resin	Blue	"Drop & Click" print ribbons for quick and easy supply changes. Ribbons are tough, smear-proof that produce long-lasting printed text. Print can withstand years in industrial areas and outdoor conditions.
R10000	B30-R10000-GN	110.00	60.00	Resin	Green	"Drop & Click" print ribbons for quick and easy supply changes. Ribbons are tough, smear-proof that produce long-lasting printed text. Print can withstand years in industrial areas and outdoor conditions.
R10000	B30-R10000-OR	110.00	60.00	Resin	Orange	"Drop & Click" print ribbons for quick and easy supply changes. Ribbons are tough, smear-proof that produce long-lasting printed text. Print can withstand years in industrial areas and outdoor conditions.
R10000	B30-R10000-RD	110.00	60.00	Resin	Red	"Drop & Click" print ribbons for quick and easy supply changes. Ribbons are tough, smear-proof that produce long-lasting printed text. Print can withstand years in industrial areas and outdoor conditions.
R10000	B30-R10000-WT	110.00	60.00	Resin	White	"Drop & Click" print ribbons for quick and easy supply changes. Ribbons are tough, smear-proof that produce long-lasting printed text. Print can withstand years in industrial areas and outdoor conditions.
R10000	B30-R10000-YL	110.00	60.00	Resin	Yellow	"Drop & Click" print ribbons for quick and easy supply changes. Ribbons are tough, smear-proof that produce long-lasting printed text. Print can withstand years in industrial areas and outdoor conditions. B30-R10000-YL is designed for printing yellow on white; use B30-R10000-YL2 (sold separately) for printing yellow onto other colours





# Thermal transfer print ribbons

## Thermal transfer print ribbons for BradyPrinter i5100



Ribbon Series	Order Reference	Roll Width (mm)	Roll Length (m)	Formulation	Colour	Notes / Details
R4300	IP-R4307	110.00	300.00	Wax/Resin	Black	Strong environmental resistance against smearing and chemicals. Also, reliable, sharp-edge print quality to maximise bar code readability. Ribbons include spindle
R4300	IP-R4300	83.00	300.00	Wax/Resin	Black	Strong environmental resistance against smearing and chemicals. Also, reliable, sharp-edge print quality to maximise bar code readability. Ribbons include spindle
R4300	IP-R4302	60.00	300.00	Wax/Resin	Black	Strong environmental resistance against smearing and chemicals. Also, reliable, sharp-edge print quality to maximise bar code readability. Ribbons include spindle
R4300	IP-R4306	40.00	300.00	Wax/Resin	Black	Strong environmental resistance against smearing and chemicals. Also, reliable, sharp-edge print quality to maximise bar code readability. Ribbons include spindle
R4400	IP-R4400-BL	60.00	300.00	Resin	Blue	This ribbon is high density, excellent solvent resistance, high heat resistance, and super scratch resistance. Ribbons include spindle
R4400	IP-R4400-RD	60.00	300.00	Resin	Red	This ribbon is high density, excellent solvent resistance, high heat resistance, and super scratch resistance. Ribbons include spindle
R4400	IP-R4402-GR	83.00	300.00	Resin	Green	This ribbon is high density, excellent solvent resistance, high heat resistance, and super scratch resistance. Ribbons include spindle
R4400	IP-R4400-GR	60.00	300.00	Resin	Green	This ribbon is high density, excellent solvent resistance, high heat resistance, and super scratch resistance. Ribbons include spindle
R4400	IP-R4402-RD	83.00	300.00	Resin	Red	This ribbon is high density, excellent solvent resistance, high heat resistance, and super scratch resistance. Ribbons include spindle
R4400	IP-R4407-RD	110.00	300.00	Resin	Red	This ribbon is high density, excellent solvent resistance, high heat resistance, and super scratch resistance. Ribbons include spindle
R4400	IP-R4407-BL	110.00	300.00	Resin	Blue	This ribbon is high density, excellent solvent resistance, high heat resistance, and super scratch resistance. Ribbons include spindle
R4900	IP-R4900	83.00	300.00	Resin	Black	This ribbon has superb smear resistance at high temperatures and superior solvent resistance. Ribbons include spindle
R4900	IP-R4902	60.00	300.00	Resin	Black	This ribbon has superb smear resistance at high temperatures and superior solvent resistance. Ribbons include spindle
R6000HF	IP-R6006HF	40.00	300.00	Resin	Black	The R-6000HF Series Thermal Transfer Ribbons are high density, halogen free ribbons with excellent solvent resistance, high heat resistance, and super scratch resistance
R6000HF	IP-R6007HF	110.00	300.00	Resin	Black	The R-6000HF Series Thermal Transfer Ribbons are high density, halogen free ribbons with excellent solvent resistance, high heat resistance, and super scratch resistance
R6000HF	IP-R6000HF	60.00	300.00	Resin	Black	The R-6000HF Series Thermal Transfer Ribbons are high density, halogen free ribbons with excellent solvent resistance, high heat resistance, and super scratch resistance
R6000HF	IP-R6002	83.00	300.00	Resin	Black	The R-6000HF Series Thermal Transfer Ribbons are high density, halogen free ribbons with excellent solvent resistance, high heat resistance, and super scratch resistance
R6200	IP-R6206	40.00	300.00	Resin	Black	Designed for harsh environment labelling applications. Superior abrasion, chemical and heat resistance. Ribbons include spindle
R6200	IP-R6200	60.00	300.00	Resin	Black	Designed for harsh environment labelling applications. Superior abrasion, chemical and heat resistance. Ribbons include spindle
R6200	IP-R6202	83.00	300.00	Resin	Black	Designed for harsh environment labelling applications. Superior abrasion, chemical and heat resistance. Ribbons include spindle
R6200	IP-R6207	110.00	300.00	Resin	Black	Designed for harsh environment labelling applications. Superior abrasion, chemical and heat resistance. Ribbons include spindle
R6400	IP-R6402	83.00	300.00	Resin	Black	Ultra high chemical resistance at high temperatures. Superior solvent resistance.
R6400	IP-R6407	110.00	300.00	Resin	Black	Ultra high chemical resistance at high temperatures. Superior solvent resistance.
R6400	IP-R6406	40.00	300.00	Resin	Black	Ultra high chemical resistance at high temperatures. Superior solvent resistance.
R6400	IP-R6400	60.00	300.00	Resin	Black	Ultra high chemical resistance at high temperatures. Superior solvent resistance.

# Thermal transfer print ribbons

## Thermal transfer print ribbons for BradyPrinter i7100



Ribbon Series	Order Reference	Roll Width (mm)	Roll Length (m)	Formulation	Colour	Notes / Details
R4300	R4307	110.00	300.00	Wax/Resin	Black	Strong environmental resistance against smearing and chemicals. Also, reliable, sharp-edge print quality to maximise bar code readability.
R4300	R4300	83.00	300.00	Wax/Resin	Black	Strong environmental resistance against smearing and chemicals. Also, reliable, sharp-edge print quality to maximise bar code readability.
R4300	R4302	60.00	300.00	Wax/Resin	Black	Strong environmental resistance against smearing and chemicals. Also, reliable, sharp-edge print quality to maximise bar code readability.
R4300	R4304	130.00	300.00	Wax/Resin	Black	Strong environmental resistance against smearing and chemicals. Also, reliable, sharp-edge print quality to maximise bar code readability.
R4300	R4306	40.00	300.00	Wax/Resin	Black	Strong environmental resistance against smearing and chemicals. Also, reliable, sharp-edge print quality to maximise bar code readability.
R4300	R4308	174.00	300.00	Wax/Resin	Black	Strong environmental resistance against smearing and chemicals. Also, reliable, sharp-edge print quality to maximise bar code readability.
R4300	R4311	25.40	300.00	Wax/Resin	Black	Strong environmental resistance against smearing and chemicals. Also, reliable, sharp-edge print quality to maximise bar code readability.
R4400	R4407-WT	110.00	300.00	Resin	White	High density ribbon, excellent solvent resistance, high heat resistance, and super scratch resistance.
R4400	R4402-WT	83.00	300.00	Resin	White	High density ribbon, excellent solvent resistance, high heat resistance, and super scratch resistance.
R4400	R4400-BL	60.00	300.00	Resin	Blue	High density ribbon, excellent solvent resistance, high heat resistance, and super scratch resistance.
R4400	R4402-BL	83.00	300.00	Resin	Blue	High density ribbon, excellent solvent resistance, high heat resistance, and super scratch resistance.
R4400	R4400-RD	60.00	300.00	Resin	Red	High density ribbon, excellent solvent resistance, high heat resistance, and super scratch resistance.
R4400	R4402-GR	83.00	300.00	Resin	Green	High density ribbon, excellent solvent resistance, high heat resistance, and super scratch resistance.
R4400	R4400-GR	60.00	300.00	Resin	Green	High density ribbon, excellent solvent resistance, high heat resistance, and super scratch resistance.
R4400	R4402-RD	83.00	300.00	Resin	Red	High density ribbon, excellent solvent resistance, high heat resistance, and super scratch resistance.
R4400	R4407-RD	110.00	300.00	Resin	Red	High density ribbon, excellent solvent resistance, high heat resistance, and super scratch resistance.
R4400	R4407-BL	110.00	300.00	Resin	Blue	High density ribbon, excellent solvent resistance, high heat resistance, and super scratch resistance.
R4400	R4400-WT	60.00	300.00	Resin	White	High density ribbon, excellent solvent resistance, high heat resistance, and super scratch resistance.
R4900	R4907-110X300/O	110.00	300.00	Resin	Black	This ribbon has superb smear resistance at high temperatures and superior solvent resistance
R4900	R4900	83.00	300.00	Resin	Black	This ribbon has superb smear resistance at high temperatures and superior solvent resistance
R4900	R4902	60.00	300.00	Resin	Black	This ribbon has superb smear resistance at high temperatures and superior solvent resistance
R4900	R4904	130.00	300.00	Resin	Black	This ribbon has superb smear resistance at high temperatures and superior solvent resistance
R6000HF	R6006HF	40.00	300.00	Resin	Black	High density halogen free ribbon, excellent solvent resistance, high heat resistance, and super scratch resistance.
R6000HF	R6000HF	60.00	300.00	Resin	Black	High density halogen free ribbon, excellent solvent resistance, high heat resistance, and super scratch resistance.
R6000HF	R6002HF-83X300	83.00	300.00	Resin	Black	High density halogen free ribbon, excellent solvent resistance, high heat resistance, and super scratch resistance.
R6000HF	R6002HF-PC	83.00	300.00	Resin	Black	High density halogen free ribbon, excellent solvent resistance, high heat resistance, and super scratch resistance. (Plastic core)
R6000HF	R6007HF	110.00	300.00	Resin	Black	High density halogen free ribbon, excellent solvent resistance, high heat resistance, and super scratch resistance.
R6000HF	R6004HF	130.00	300.00	Resin	Black	High density halogen free ribbon, excellent solvent resistance, high heat resistance, and super scratch resistance.
R6000HF	R6000HF-30X300/O	30.00	300.00	Resin	Black	High density halogen free ribbon, excellent solvent resistance, high heat resistance, and super scratch resistance.
R6200	R6206	40.00	300.00	Resin	Black	Designed for harsh environment labelling applications. Superior abrasion, chemical and heat resistance.
R6400	R6407	110.00	300.00	Resin	Black	Ultra high chemical resistance at high temperatures. Superior solvent resistance.
R6400	R6406	40.00	300.00	Resin	Black	Ultra high chemical resistance at high temperatures. Superior solvent resistance.
R6400	R6400	60.00	300.00	Resin	Black	Ultra high chemical resistance at high temperatures. Superior solvent resistance.
R6400	R6402	83.00	300.00	Resin	Black	Ultra high chemical resistance at high temperatures. Superior solvent resistance.
R7942	R7942-90X300/O	90.00	300.00	Wax	Black	General purpose, standard performance wax ribbon for paper and temporary labelling.
R7950	R7950-130X300/O	130.00	300.00	Wax/Resin	Black	Strong environmental resistance against smearing and chemicals. Also, reliable, sharp-edge print quality to maximise bar code readability.
R7950	R7950-114X300/I	114.00	300.00	Wax/Resin	Black	Strong environmental resistance against smearing and chemicals. Also, reliable, sharp-edge print quality to maximise bar code readability.
R7950	R7950-110X300/O	110.00	300.00	Wax/Resin	Black	Strong environmental resistance against smearing and chemicals. Also, reliable, sharp-edge print quality to maximise bar code readability.
R7950	R7950-90X300/O	90.00	300.00	Wax/Resin	Black	Strong environmental resistance against smearing and chemicals. Also, reliable, sharp-edge print quality to maximise bar code readability.
R7950	R7950-40X300/O	40.00	300.00	Wax/Resin	Black	Strong environmental resistance against smearing and chemicals. Also, reliable, sharp-edge print quality to maximise bar code readability.
R7950	R7950-60X300/O	60.00	300.00	Wax/Resin	Black	Strong environmental resistance against smearing and chemicals. Also, reliable, sharp-edge print quality to maximise bar code readability.
R7950	R7950-83X320/O	83.00	320.00	Wax/Resin	Black	Strong environmental resistance against smearing and chemicals. Also, reliable, sharp-edge print quality to maximise bar code readability.
R7950	R7950-170X300/O	170.00	300.00	Wax/Resin	Black	Strong environmental resistance against smearing and chemicals. Also, reliable, sharp-edge print quality to maximise bar code readability.
R7950	R7950-25X300/O	25.40	300.00	Wax/Resin	Black	Strong environmental resistance against smearing and chemicals. Also, reliable, sharp-edge print quality to maximise bar code readability.



## Vial / Tube Labels

Brady's vial and test tube labels are designed to withstand extreme laboratory solvents like Xylene, Ethanol, Alcohol and DMSO, ensuring that the specimen identification is always legible - and will not smear, fade or fall off.

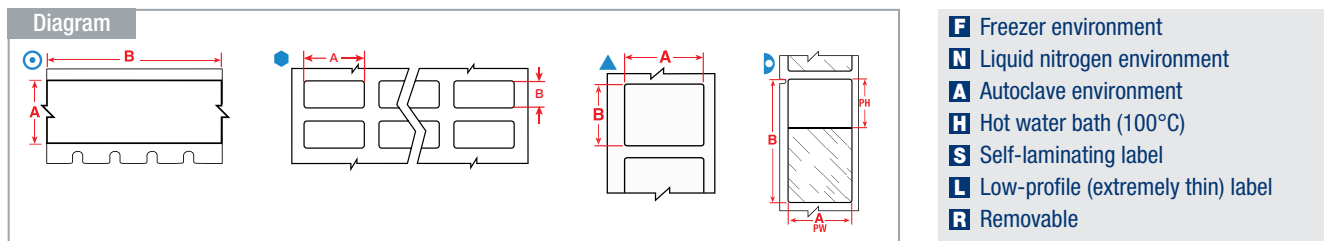

The background colours in the Order Reference column represent the material colour.

See page 54 for Brady's range of label printers.

Labels are shown per vial / tube size and in order of label width.

Diagram	Material	Special Properties	Label Width A (mm)	Label Height B (mm)	Label Length B (m)	Printable Area Width PW (mm)	Printable Area Height PH (mm)	Order Reference	Printer Compatibility	Printer Ribbon Series	Labels per Roll	Labels per Row
<b>0.5 ml</b>												
⊙	B-423	<b>F A H</b>	6.35	-	6.40	-	-	M21-250-423	M210-LAB, M211	R6200	1	-
▶	B-461	<b>F N A H S L</b>	9.53	45.72	-	9.53	19.05	M7-73-461	M710	R6200	250	1
⊙	B-499	<b>F N A</b>	9.53	-	4.88	-	-	M4C-375-499	M511, BMP41, BMP51	R4300	1	-
⊙	B-499	<b>F N A</b>	9.53	-	4.88	-	-	M21-375-499	M210-LAB, M211	R4300	1	-
⊙	B-7425	<b>F N A H</b>	9.53	-	6.40	-	-	M21-375-7425	M210-LAB, M211	R4300	1	-
⊙	B-461	<b>F N A H S L</b>	9.53	-	6.40	-	-	M21-375-461-AW**	M210-LAB, M211	R4300	1	-
⊙	B-461	<b>F N A H S L</b>	9.53	-	7.62	-	-	M4C-375-461	M511, BMP41, BMP51	R4300	1	-
⊙	B-461	<b>F N A H S L</b>	9.53	-	15.24	-	-	M6C-375-461	M610, M611	R4300, R6200	1	1
⬢	B-499	<b>F N A</b>	12.70	19.05	-	-	-	B33-68-499	i3300	B30 Monocolour Series	1500	4
⬢	B-490	<b>F N H L</b>	12.70	19.05	-	-	-	B33-68-490	i3300	B30 Monocolour Series	2500	4
⬢	B-499	<b>F N A</b>	12.70	19.05	-	-	-	THT-68-499-10	BBP12, i7100, i5100	R4900	10000	4
▲	B-499	<b>F N A</b>	12.70	25.40	-	-	-	B33-620-499	i3300	B30-R6000	1000	1
⬢	B-499	<b>F N A</b>	12.70	25.40	-	-	-	B33-611-499	i3300	B30-R6000	3000	3
▲	B-499	<b>F N A</b>	12.70	25.40	-	-	-	BPT-620-499	BBP12	R7950	1000	1
⬢	B-499	<b>F N A</b>	12.70	25.40	-	-	-	BPT-611-499	BBP12	R7950	3000	3
⊙	B-499	<b>F N A</b>	12.70	-	4.88	-	-	M4C-500-499	M511, BMP41, BMP51	R4300	1	-
⊙	B-499	<b>F N A</b>	12.70	-	4.88	-	-	M21-500-499	M210-LAB, M211	R4300	1	-
⊙	B-7425	<b>F N A H</b>	12.70	-	6.40	-	-	M21-500-7425	M210-LAB, M211	R4300	1	-
⊙	B-461	<b>F N A H S L</b>	12.70	-	6.40	-	-	M21-500-461-AW**	M210-LAB, M211	R4300	1	-
⊙	B-461	<b>F N A H S L</b>	12.70	-	7.62	-	-	M4C-500-461	M511, BMP41, BMP51	R4300	1	-
⊙	B-499	<b>F N A</b>	12.70	-	9.14	-	-	M7C-500-499	M710	R4300, R6000HF, R6200	1	1
⊙	B-461	<b>F N A H S L</b>	12.70	-	15.24	-	-	M6C-500-461	M610, M611	R4300, R6200	1	1
▲	B-499	<b>F N A</b>	19.05	12.70	-	-	-	M21-11-499	M210-LAB, M211	R4300	1	1
▲	B-423	<b>F A H</b>	19.05	12.70	-	-	-	M21-7-423	M210-LAB, M211	R6000HF	1	1
▲	B-492	<b>F N H L</b>	20.96	9.53	-	-	-	M6-130-492	M610, M611	R4300, R6400	500	1
▲	B-499	<b>F N A</b>	22.86	12.70	-	-	-	B33-125-499	i3300	B30 Monocolour Series	1500	1
▲	B-490	<b>F N H L</b>	22.86	12.70	-	-	-	B33-125-490	i3300	B30 Monocolour Series	1650	1
▲	B-499	<b>F N A</b>	22.86	12.70	-	-	-	M6-84-499	M610, M611	R4300, R6200	500	1
▲	B-499	<b>F N A</b>	22.86	12.70	-	-	-	M7-84-499	M710	R4300, R6000HF, R6200	500	1
▲	B-499	<b>F N A</b>	22.86	12.70	-	-	-	THT-125-499-3	BBP12, i7100, i5100	R4900	3000	1

\*\*AW = All White / no transparent area.



# Vial / Tube Labels

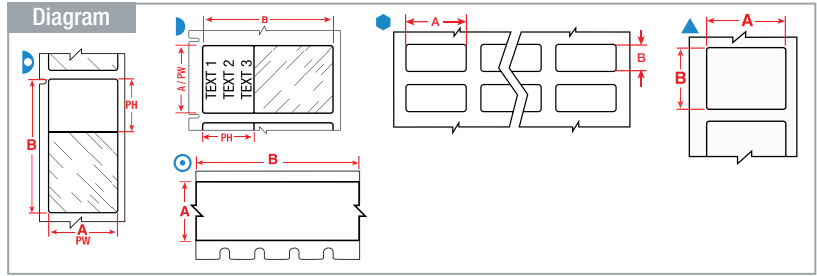

The background colours in the Order Reference column represent the material colour.

See page 54 for Brady's range of label printers.

Labels are shown per vial / tube size and in order of label width.

Diagram	Material	Special Properties	Label Width A (mm)	Label Height B (mm)	Label Length B (mm)	Printable Area Width PW (mm)	Printable Area Height PH (mm)	Order Reference	Printer Compatibility	Printer Ribbon Series	Labels per Roll	Labels per Row
<b>0.5 ml</b>												
▲	B-499	FNA	22.86	12.70	-	-	-	THT-125-499-1.5-SC	BBP12	R7950, R4300, R4900	1500	1
●	B-499	FNA	25.40	9.53	-	-	-	B33-152-499	i3300	B30 Monocolour Series	1500	2
●	B-492	FNHL	25.40	9.53	-	-	-	B33-152-492	i3300	B30 Monocolour Series	2500	2
▲	B-7425J	FNAH	25.40	9.53	-	-	-	J-152-7425J	J7300		1	2
▲	B-492	FNHL	25.40	9.53	-	-	-	M7-16-492	M710	R6400	500	1
●	B-499	FNA	25.40	9.53	-	-	-	THT-152-499-3	BBP12, i7100, i5100	R4900	3000	2
●	B-499	FNA	25.40	9.53	-	-	-	THT-152-499-1.5-SC	BBP12	R7950, R4300, R4900	1500	2
●	B-492	FNHL	25.40	9.53	-	-	-	THT-152-492-3	BBP12, i7100, i5100	R6400	3000	2
●	B-492	FNHL	25.40	9.53	-	-	-	THT-152-492-2.5-SC	BBP12	R6400	2500	2
▲	B-499	FNA	25.40	12.45	-	-	-	B33-659-499	i3300	B30-R6000	1000	1
▲	B-492	FNHL	25.40	12.70	-	-	-	B33-59-492	i3300	B30 Monocolour Series	2500	1
●	B-499	FNA	25.40	12.70	-	-	-	B33-5-499	i3300, i5300	B30 Monocolour Series	5000	3
▲	B-7425J	FNAH	25.40	12.70	-	-	-	J-59-7425J	J7300		1	1
▲	B-492	FNHL	25.40	12.70	-	-	-	M6-17-492	M610, M611	R4300, R6400	500	1
▲	B-499	FNA	25.40	12.70	-	-	-	M21-131-499	M210-LAB, M211	R4300	1	1
▲	B-423	FAH	25.40	12.70	-	-	-	M21-17-423	M210-LAB, M211	R6000HF	1	1
▲	B-492	FNHL	25.40	12.70	-	-	-	THT-59-492-10	BBP12, i7100, i5100	R6400	10000	1
▲	B-492	FNHL	25.40	12.70	-	-	-	THT-59-492-2.5-SC	BBP12	R6400	2500	1
⌋	B-461	FNAHSL	28.58	12.70	-	19.05	12.70	M6-122-461	M610, M611	R4300, R6200	500	1
⌋	B-461	FNAHSL	41.91	12.70	-	19.05	12.70	M6-202-461	M610, M611	R4300, R6200	500	1
⌋	B-461	FNAHSL	55.88	12.70	-	19.05	12.70	B33-127-461	i3300	B30 Monocolour Series	1500	3
⌋	B-461	FNAHSL	55.88	12.70	-	19.05	12.70	THT-127-461-3*	BBP12, i7100, i5100	R4300, R7950	3000	1
⌋	B-461	FNAHSL	55.88	12.70	-	19.05	12.70	THT-127-461-1.5-SC*	BBP12	R7950	1500	1
<b>1.5 ml</b>												
⌋	B-461	FNAHSL	15.24	41.28	-	15.24	25.40	M7-76-461	M710	R6200	500	1
●	B-499	FNA	19.05	6.35	-	-	-	B33-1-499	i3300, i5300	B30 Monocolour Series	10000	4
▲	B-499	FNA	19.05	19.05	-	-	-	B33-254-499	i3300, i5300	B30 Monocolour Series	1000	1
●	B-499	FNA	19.05	23.80	-	-	-	B33-91-499	i3300, i5300	B30 Monocolour Series	2500	4
▲	B-499	FNA	19.05	25.40	-	-	-	M7-18-499	M710	R4300, R6000HF, R6200	250	1
⊙	B-499	FNA	19.05	-	4.88	-	-	M4C-750-499	M511, BMP41, BMP51	R4300	1	-
⊙	B-499	FNA	19.05	-	4.88	-	-	M21-750-499	M210-LAB, M211	R4300	1	-
⊙	B-7425	FNAH	19.05	-	6.40	-	-	M21-750-7425	M210-LAB, M211	R4300	1	-
⊙	B-461	FNAHSL	19.05	-	6.40	-	-	M21-750-461-AW**	M210-LAB, M211	R4300	1	-
●	B-499	FNA	25.40	19.05	-	-	-	B33-88-499	i3300, i5300	B30 Monocolour Series	2500	2
●	B-7425J	FNAH	25.40	19.05	-	-	-	J-88-7425J	J7300		1	2
▲	B-499	FNA	25.40	19.05	-	-	-	M21-18-499	M210-LAB, M211	R4300	1	1
▲	B-423	FAH	25.40	19.05	-	-	-	M21-18-423	M210-LAB, M211	R6000HF	1	1
●	B-492	FNHL	25.40	19.05	-	-	-	THT-88-492-5	BBP12, i7100, i5100	R6400	5000	2
▲	B-492	FNHL	25.40	19.05	-	-	-	THT-88-492-2.5-SC	BBP12	R6400	2500	2
⌋	B-461	FNAHSL	28.58	9.53	-	19.05	9.53	M6-123-461	M610, M611	R4300, R6200	500	1
⌋	B-461	FNAHSL	45.72	15.24	-	25.40	15.24	M6-201-461	M610, M611	R4300, R6200	100	1
⌋	B-461	FNAHSL	66.68	15.24	-	25.40	15.24	B33-153-461	i3300	B30 Monocolour Series	1500	1
⌋	B-461	FNAHSL	66.68	15.24	-	25.40	15.24	THT-153-461-3*	BBP12, i7100, i5100	R4300, R7950	3000	1
⌋	B-461	FNAHSL	66.68	15.24	-	25.40	15.24	THT-153-461-1.5-SC*	BBP12	R7950	1500	1
⌋	B-461	FNAHSL	95.25	19.05	-	25.40	25.40	M6-79-461	M610, M611	R4300, R6200	100	1

\*Label is rotated 90° on liner.

\*\*AW = All White / no transparent area.

>>

<b>F</b> Freezer environment	<b>N</b> Liquid nitrogen environment	<b>A</b> Autoclave environment	<b>H</b> Hot water bath (100°C)	<b>S</b> Self-laminating label	<b>L</b> Low-profile (extremely thin) label	<b>R</b> Removable
------------------------------	--------------------------------------	--------------------------------	---------------------------------	--------------------------------	---	--------------------

# Vial / Tube Labels

Diagram

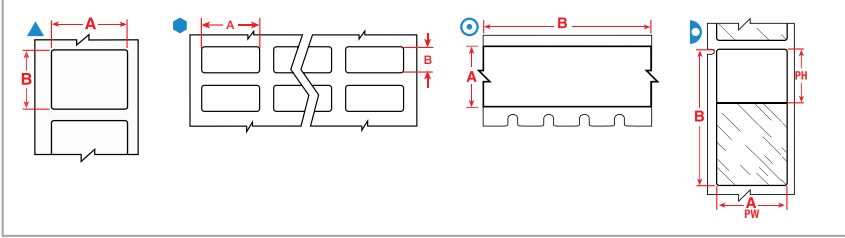

The background colours in the Order Reference column represent the material colour.

See page 54 for Brady's range of label printers.

Labels are shown per vial / tube size and in order of label width.

Diagram	Material	Special Properties	Label Width A (mm)	Label Height B (mm)	Label Length B (m)	Printable Area Width PW (mm)	Printable Area Height PH (mm)	Order Reference	Printer Compatibility	Printer Ribbon Series	Labels per Roll	Labels per Row
<b>2.0 ml</b>												
	B-499	<b>FNA</b>	6.35	36.50	-	-	-	B33-90-499	i3300, i5300	B30 Monocolour Series	2500	6
	B-461	<b>FNAHSL</b>	15.00	40.00	-	15.00	29.97	BPTLAB-21-461-2.5	BBP12	R7950	2500	1
	B-461	<b>FNAHSL</b>	15.24	38.10	-	15.24	33.00	M7-100-461	M710	R6200	500	1
	B-461	<b>FNAHSL</b>	15.24	38.10	-	15.24	33.02	B33-628-461	i3300	B30-R4300	2500	2
	B-461	<b>FNAHSL</b>	15.24	38.10	-	15.24	33.02	BPT-628-461	BBP12	R7950	2500	2
	B-461	<b>FNAHSL</b>	15.24	66.68	-	15.24	25.40	B33-612-461	i3300	B30-R4300	1500	3
	B-461	<b>FNAHSL</b>	15.24	66.68	-	15.24	25.40	BPT-612-461	BBP12	R7950	1500	3
	B-492	<b>FNAHSL</b>	22.86	25.40	-	-	-	B33-180-492	i3300	B30 Monocolour Series	1500	1
	B-492	<b>FNHL</b>	22.86	25.40	-	-	-	M6-156-492	M610, M611	R4300, R6400	250	1
	B-492	<b>FNHL</b>	22.86	25.40	-	-	-	THT-180-492-3	BBP12, i7100, i5100	R6400	3000	1
	B-494	<b>FNH</b>	25.40	12.70	-	-	-	B33-310-494-BL	i3300, i5300	R6400	2500	1
	B-494	<b>FNH</b>	25.40	12.70	-	-	-	B33-310-494-GN	i3300, i5300	R6400	2500	1
	B-494	<b>FNH</b>	25.40	12.70	-	-	-	B33-310-494-OR	i3300, i5300	R6400	2500	1
	B-494	<b>FNH</b>	25.40	12.70	-	-	-	B33-310-494-PK	i3300, i5300	R6400	2500	1
	B-494	<b>FNH</b>	25.40	12.70	-	-	-	B33-310-494-RD	i3300, i5300	R6400	2500	1
	B-494	<b>FNH</b>	25.40	12.70	-	-	-	B33-310-494-YL	i3300, i5300	R6400	2500	1
	B-494	<b>FNH</b>	25.40	12.70	-	-	-	BPT-310-494-2.5-BL	BBP12	R6400	2500	1
	B-494	<b>FNH</b>	25.40	12.70	-	-	-	BPT-310-494-2.5-GN	BBP12	R6400	2500	1
	B-494	<b>FNH</b>	25.40	12.70	-	-	-	BPT-310-494-2.5-OR	BBP12	R6400	2500	1
	B-494	<b>FNH</b>	25.40	12.70	-	-	-	BPT-310-494-2.5-PK	BBP12	R6400	2500	1
	B-494	<b>FNH</b>	25.40	12.70	-	-	-	BPT-310-494-2.5-RD	BBP12	R6400	2500	1
	B-494	<b>FNH</b>	25.40	12.70	-	-	-	BPT-310-494-2.5-YL	BBP12	R6400	2500	1
	B-494	<b>FNH</b>	25.40	12.70	-	-	-	THT-310-494-10-BL	i5100, i7100	R6400	10000	1
	B-494	<b>FNH</b>	25.40	12.70	-	-	-	THT-310-494-10-GN	i5100, i7100	R6400	10000	1
	B-494	<b>FNH</b>	25.40	12.70	-	-	-	THT-310-494-10-OR	i5100, i7100	R6400	10000	1
	B-494	<b>FNH</b>	25.40	12.70	-	-	-	THT-310-494-10-PK	i5100, i7100	R6400	10000	1
	B-494	<b>FNH</b>	25.40	12.70	-	-	-	THT-310-494-10-RD	i5100, i7100	R6400	10000	1
	B-494	<b>FNH</b>	25.40	12.70	-	-	-	THT-310-494-10-YL	i5100, i7100	R6400	10000	1
	B-492	<b>FNHL</b>	25.40	25.40	-	-	-	B33-179-492	i3300	B30 Monocolour Series	1900	1
	B-7425J	<b>FNAH</b>	25.40	25.40	-	-	-	J-179-7425J	J7300		1	1
	B-492	<b>FNHL</b>	25.40	25.40	-	-	-	M6-19-492	M610, M611	R4300, R6400	250	1
	B-492	<b>FNHL</b>	25.40	25.40	-	-	-	THT-179-492-3	BBP12, i7100, i5100	R6400	3000	1
	B-492	<b>FNHL</b>	25.40	25.40	-	-	-	THT-179-492-2.5-SC	BBP12	R6400	2500	1
	B-461	<b>FNAHSL</b>	25.40	44.45	-	25.40	25.40	M7-106-461	M710	R6200	250	1
	B-461	<b>FNAHSL</b>	25.40	66.68	-	25.40	25.40	M7-115-461	M710	R6200	100	1
	B-499	<b>FNA</b>	25.40	-	4.88	-	-	M5C-1000-499	M511, BMP51	R4300	1	-
	B-7425	<b>FNAH</b>	25.40	-	7.62	-	-	M4C-1000-7425	M410, M510, M511	R4300	1	-
	B-423	<b>FAH</b>	25.40	-	7.62	-	-	M4C-1000-423	M410, M510, M511	R6200	1	-
	B-499	<b>FNA</b>	25.40	-	9.14	-	-	M7C-1000-499	M710	R4300, R6000HF, R6200	1	1
	B-7425J	<b>FNAH</b>	33.02	15.24	-	-	-	J-256-7425J	J7300		1	1
	B-461	<b>FNAHSL</b>	44.45	25.40	-	25.40	25.40	B33-183-461	i3300	B30 Monocolour Series	2000	1
	B-461	<b>FNAHSL</b>	44.45	25.40	-	25.40	25.40	M6-203-461	M610, M611	R4300, R6200	100	1
	B-461	<b>FNAHSL</b>	44.45	25.40	-	25.40	25.40	THT-183-461-1	BBP12, i7100, i5100	R4300, R7950	1000	1

>>

**F** Freezer environment    **N** Liquid nitrogen environment    **A** Autoclave environment    **H** Hot water bath (100°C)    **S** Self-laminating label    **L** Low-profile (extremely thin) label    **R** Removable

# Vial / Tube Labels

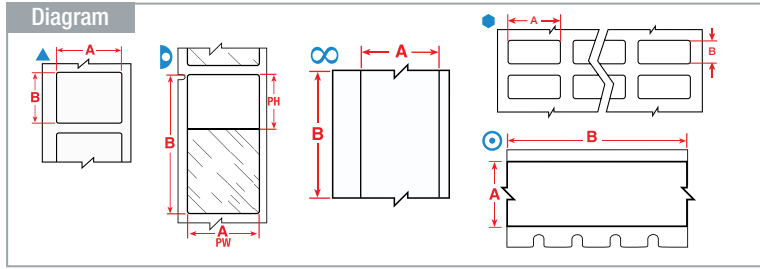

The background colours in the Order Reference column represent the material colour.

See page 54 for Brady's range of label printers.

Labels are shown per vial / tube size and in order of label width.

Diagram	Material	Special Properties	Label Width A (mm)	Label Height B (mm)	Label Length B (m)	Printable Area Width PW (mm)	Printable Area Height PH (mm)	Order Reference	Printer Compatibility	Printer Ribbon Series	Labels per Roll	Labels per Row
<b>4.0 ml</b>												
⬠	B-499	<b>FNA</b>	12.70	36.50	-	-	-	B33-87-499	i3300, i5300	B30 Monocolour Series	2500	6
⬠	B-7425J	<b>FNAH</b>	12.70	38.10	-	-	-	J-37-7425J	J7300		1	2
⬠	B-492	<b>FNHL</b>	12.70	41.91	-	-	-	M5-124-492	M511, BMP51	R6400	180	-
⬠	B-492	<b>FNHL</b>	12.70	41.91	-	-	-	M6-124-492	M610, M611	R4300, R6400	500	1
⬠	B-461	<b>FNAHSL</b>	15.24	48.26	-	15.24	39.88	B33-638-461	i3300	B30-R4300	2000	1
⬠	B-461	<b>FNAHSL</b>	15.24	48.26	-	15.24	39.88	BPT-638-461	BBP12	R7950	2000	1
⬠	B-461	<b>FNAHSL</b>	15.24	48.26	-	15.24	40.00	M7-119-461	M710	R6200	500	1
⬠	B-499	<b>FNA</b>	25.40	36.50	-	-	-	B33-621-499	i3300	B30-R6000	3000	3
⬠	B-499	<b>FNA</b>	25.40	36.50	-	-	-	B33-89-499	i3300, i5300	B30 Monocolour Series	2300	3
⬠	B-499	<b>FNA</b>	25.40	36.50	-	-	-	BPT-621-499	BBP12	R7950	3000	3
⬠	B-7425J	<b>FNAH</b>	28.58	-	45.72	-	-	JC-1125-7425J	J7300		1	1
⬠	B-461	<b>FNAHSL</b>	34.93	45.72	-	34.93	39.88	B33-632-461	i3300	B30-R4300	1500	1
⬠	B-461	<b>FNAHSL</b>	34.93	45.72	-	34.93	39.88	BPT-632-461	BBP12	R7950	2000	1
⬠	B-7425J	<b>FNAH</b>	38.10	19.05	-	-	-	J-136-7425J	J7300		1	1
⬠	B-499	<b>FNA</b>	38.10	19.05	-	-	-	M21-136-499	M210-LAB, M211	R4300	1	1
⬠	B-423	<b>FAH</b>	38.10	19.05	-	-	-	M21-30-423	M210-LAB, M211	R6000HF	1	1
⬠	B-7425J	<b>FNAH</b>	38.10	25.40	-	-	-	J-235-7425J	J7300		1	1
⬠	B-7425	<b>FNAH</b>	38.10	25.40	-	-	-	M5-31-7425	M511, BMP51	R4300	250	1
⬠	B-7425J	<b>FNAH</b>	38.10	44.45	-	-	-	J-258-7425J	J7300		1	1
⬠	B-7425	<b>FNAH</b>	38.10	-	7.62	-	-	M5C-1500-7425	M510, M511	R4300	1	-
⬠	B-461	<b>FNAHSL</b>	41.28	15.24	-	25.40	15.24	B33-133-461	i3300	B30 Monocolour Series	1500	3
⬠	B-461	<b>FNAHSL</b>	41.28	15.24	-	25.40	15.24	THT-133-461-3*	BBP12, i7100, i5100	R4300, R7950	3000	1
⬠	B-461	<b>FNAHSL</b>	41.28	15.24	-	25.40	15.24	THT-133-461-1.5-SC*	BBP12	R7950	1500	1
⬠	B-492	<b>FNHL</b>	41.28	15.24	-	-	-	B33-155-492	i3300	B30 Monocolour Series	1500	1
⬠	B-490	<b>FNHL</b>	41.28	15.24	-	-	-	B33-155-490	i3300	B30 Monocolour Series	1500	1
⬠	B-490	<b>FNHL</b>	41.28	15.24	-	-	-	M7-76-490	M710	R4300	500	1
⬠	B-492	<b>FNHL</b>	41.28	15.24	-	-	-	THT-155-492-3	BBP12, i7100, i5100	R6400	3000	1
⬠	B-490	<b>FNHL</b>	41.28	15.24	-	-	-	THT-155-490-3	BBP12, i7100, i5100	R4300, R7950	3000	1
⬠	B-490	<b>FNHL</b>	41.28	15.24	-	-	-	THT-155-490-1.5-SC	BBP12	R7950	1500	1
⬠	B-499	<b>FNA</b>	48.26	-	9.14	-	-	M7C-1900-499	M710	R4300, R6000HF, R6200	1	1
⬠	B-490	<b>FNHL</b>	50.80	6.35	-	-	-	B33-151-490	i3300	B30 Monocolour Series	2500	1
⬠	B-461	<b>FNAHSL</b>	66.68	25.40	-	25.40	25.40	B33-276-461	i3300	B30 Monocolour Series	1500	2
⬠	B-461	<b>FNAHSL</b>	66.68	25.40	-	25.40	25.40	BM-75-461	M610, M611, M710	R4300, R6200	1000	1
⬠	B-461	<b>FNAHSL</b>	66.68	25.40	-	25.40	25.40	M6-75-461	M610, M611	R4300, R6200	100	1
⬠	B-461	<b>FNAHSL</b>	66.68	25.40	-	25.40	25.40	M6-75-461-YL	M610, M611	R4300, R6200	100	1
⬠	B-461	<b>FNAHSL</b>	66.68	25.40	-	25.40	25.40	THT-131-461-3*	BBP12, i7100, i5100	R4300, R7950	3000	1
⬠	B-461	<b>FNAHSL</b>	66.68	25.40	-	25.40	25.40	THT-131-461-1.5-SC*	BBP12	R7950	1500	1
⬠	B-461	<b>FNAHSL</b>	88.90	38.10	-	31.75	38.10	B33-134-461	i3300	B30 Monocolour Series	1000	1
⬠	B-461	<b>FNAHSL</b>	88.90	38.10	-	31.75	38.10	THT-134-461-3*	BBP12, i7100, i5100	R4300, R7950	3000	1

\*Label is rotated 90° on liner.

>>

**F** Freezer environment    **N** Liquid nitrogen environment    **A** Autoclave environment    **H** Hot water bath (100°C)    **S** Self-laminating label    **L** Low-profile (extremely thin) label    **R** Removable

# Vial / Tube Labels

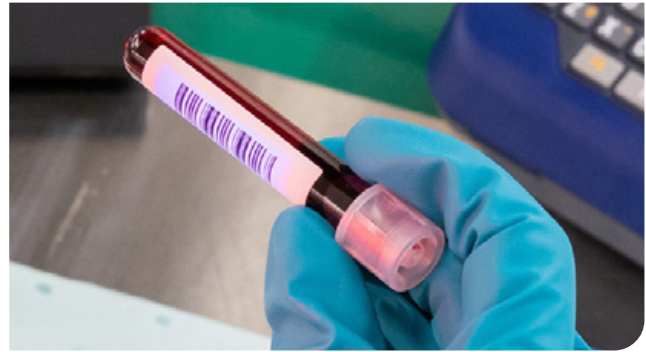
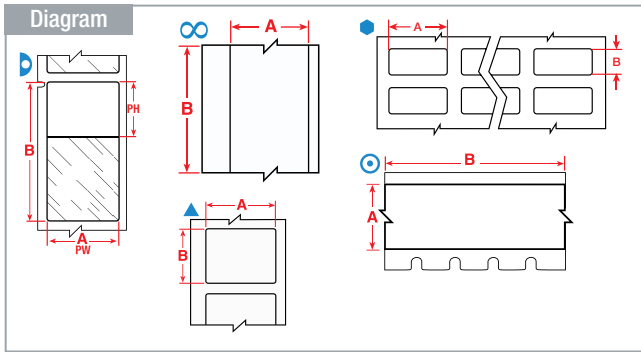

The background colours in the Order Reference column represent the material colour.

See page 54 for Brady's range of label printers.

Labels are shown per vial / tube size and in order of label width.

Diagram	Material	Special Properties	Label Width A (mm)	Label Height B (mm)	Label Length B (m)	Printable Area Width PW (mm)	Printable Area Height PH (mm)	Order Reference	Printer Compatibility	Printer Ribbon Series	Labels per Roll	Labels per Row
<b>8.0 ml</b>												
	B-461	<b>F N A H S L</b>	15.24	66.68	–	15.24	25.40	M7-86-461	M710	R6200	100	1
	B-494	<b>F N H</b>	25.40	12.70	–	25.40	9.53	M5-131-494-BL	M511, BMP51	R6400	180	–
	B-494	<b>F N H</b>	25.40	12.70	–	25.40	9.53	M5-131-494-GN	M511, BMP51	R6400	180	–
	B-494	<b>F N H</b>	25.40	12.70	–	25.40	9.53	M5-131-494-OR	M511, BMP51	R6400	180	–
	B-494	<b>F N H</b>	25.40	12.70	–	25.40	9.53	M5-131-494-PK	M511, BMP51	R6400	180	–
	B-494	<b>F N H</b>	25.40	12.70	–	25.40	9.53	M5-131-494-RD	M511, BMP51	R6400	180	–
	B-494	<b>F N H</b>	25.40	12.70	–	25.40	9.53	M5-131-494-YL	M511, BMP51	R6400	180	–
	B-494	<b>F N H</b>	25.40	12.70	–	25.40	9.53	M6-17-494-BL	M611, M610	R6400	500	1
	B-494	<b>F N H</b>	25.40	12.70	–	25.40	9.53	M6-17-494-GN	M611, M610	R6400	500	1
	B-494	<b>F N H</b>	25.40	12.70	–	25.40	9.53	M6-17-494-OR	M611, M610	R6400	500	1
	B-494	<b>F N H</b>	25.40	12.70	–	25.40	9.53	M6-17-494-PK	M611, M610	R6400	500	1
	B-494	<b>F N H</b>	25.40	12.70	–	25.40	9.53	M6-17-494-RD	M611, M610	R6400	500	1
	B-494	<b>F N H</b>	25.40	12.70	–	25.40	9.53	M6-17-494-YL	M611, M610	R6400	500	1
	B-494	<b>F N H</b>	25.40	25.40	–	25.40	22.23	M5-49-494-BL	M511, BMP51	R6400	260	–
	B-494	<b>F N H</b>	25.40	25.40	–	25.40	22.23	M5-49-494-GN	M511, BMP51	R6400	260	–
	B-494	<b>F N H</b>	25.40	25.40	–	25.40	22.23	M5-49-494-OR	M511, BMP51	R6400	260	–
	B-494	<b>F N H</b>	25.40	25.40	–	25.40	22.23	M5-49-494-PK	M511, BMP51	R6400	260	–
	B-494	<b>F N H</b>	25.40	25.40	–	25.40	22.23	M5-49-494-RD	M511, BMP51	R6400	260	–
	B-494	<b>F N H</b>	25.40	25.40	–	25.40	22.23	M5-49-494-YL	M511, BMP51	R6400	260	–
	B-494	<b>F N H</b>	25.40	25.40	–	25.40	22.23	M6-19-494-BL	M611, M610	R6400	250	1
	B-494	<b>F N H</b>	25.40	25.40	–	25.40	22.23	M6-19-494-GN	M611, M610	R6400	250	1
	B-494	<b>F N H</b>	25.40	25.40	–	25.40	22.23	M6-19-494-OR	M611, M610	R6400	250	1
	B-494	<b>F N H</b>	25.40	25.40	–	25.40	22.23	M6-19-494-PK	M611, M610	R6400	250	1
	B-494	<b>F N H</b>	25.40	25.40	–	25.40	22.23	M6-19-494-RD	M611, M610	R6400	250	1
	B-494	<b>F N H</b>	25.40	25.40	–	25.40	22.23	M6-19-494-YL	M611, M610	R6400	250	1
	B-494	<b>F N H</b>	25.40	25.40	–	25.40	22.23	THT-179-494-BL	i7100, i5100, BBP12	R6400	3000	1
	B-494	<b>F N H</b>	25.40	25.40	–	25.40	22.23	THT-179-494-GN	i7100, i5100, BBP12	R6400	3000	1
	B-494	<b>F N H</b>	25.40	25.40	–	25.40	22.23	THT-179-494-OR	i7100, i5100, BBP12	R6400	3000	1
	B-494	<b>F N H</b>	25.40	25.40	–	25.40	22.23	THT-179-494-PK	i7100, i5100, BBP12	R6400	3000	1
	B-494	<b>F N H</b>	25.40	25.40	–	25.40	22.23	THT-179-494-RD	i7100, i5100, BBP12	R6400	3000	1
	B-494	<b>F N H</b>	25.40	25.40	–	25.40	22.23	THT-179-494-YL	i7100, i5100, BBP12	R6400	3000	1
	B-492	<b>F N H L</b>	25.40	44.45	–	–	–	M6-203-492	M610, M611	R4300, R6400	250	1
	B-499	<b>F N A</b>	25.40	66.68	–	–	–	B33-625-499	i3300	B30-R6000	1500	3
	B-499	<b>F N A</b>	25.40	66.68	–	–	–	BPT-625-499	BBP12	R7950	1500	3
	B-494	<b>F N H</b>	41.28	15.24	–	–	–	B33-302-494-BL	i3300, i5300	R6400	1500	1
	B-494	<b>F N H</b>	41.28	15.24	–	–	–	B33-302-494-GN	i3300, i5300	R6400	1500	1
	B-494	<b>F N H</b>	41.28	15.24	–	–	–	B33-302-494-OR	i3300, i5300	R6400	1500	1
	B-494	<b>F N H</b>	41.28	15.24	–	–	–	B33-302-494-PK	i3300, i5300	R6400	1500	1
	B-494	<b>F N H</b>	41.28	15.24	–	–	–	B33-302-494-RD	i3300, i5300	R6400	1500	1
	B-494	<b>F N H</b>	41.28	15.24	–	–	–	B33-302-494-YL	i3300, i5300	R6400	1500	1

>>

**F** Freezer environment    **N** Liquid nitrogen environment    **A** Autoclave environment    **H** Hot water bath (100°C)    **S** Self-laminating label    **L** Low-profile (extremely thin) label    **R** Removable

# Vial / Tube Labels

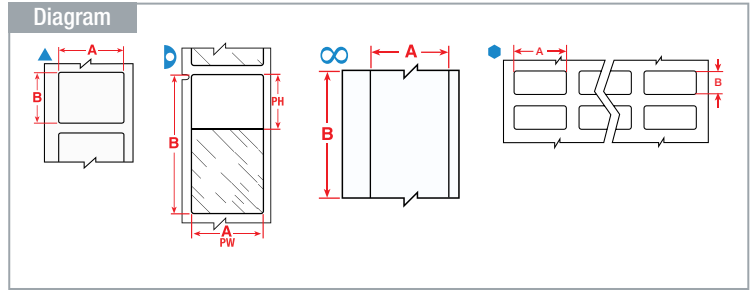

The background colours in the Order Reference column represent the material colour. See page 54 for Brady's range of label printers.

Labels are shown per vial / tube size and in order of label width.

Diagram	Material	Special Properties	Label Width A (mm)	Label Height B (mm)	Label Length B (m)	Printable Area Width PW (mm)	Printable Area Height PH (mm)	Order Reference	Printer Compatibility	Printer Ribbon Series	Labels per Roll	Labels per Row
<b>8.0 ml</b>												
▲	B-492	<b>F N H L</b>	44.45	25.40	-	-	-	M5-125-492	M511, BMP51	R6400	180	-
▲	B-492	<b>F N H L</b>	48.26	25.40	-	-	-	B33-156-492	i3300	B30 Monocolour Series	1500	1
▲	B-490	<b>F N H L</b>	48.26	25.40	-	-	-	B33-156-490	i3300	B30 Monocolour Series	1500	1
▲	B-7425J	<b>F N A H</b>	48.26	25.40	-	-	-	J-156-7425J	J7300		1	1
▲	B-490	<b>F N H L</b>	48.26	25.40	-	-	-	M6-78-490	M610, M611	R4300	250	1
▲	B-492	<b>F N H L</b>	48.26	25.40	-	-	-	M7-78-492	M710	R6400	250	1
▲	B-494	<b>F N H</b>	48.26	25.40	-	-	-	THT-303-494-3-BL	i5100, i7100	R6400	3000	1
▲	B-494	<b>F N H</b>	48.26	25.40	-	-	-	THT-303-494-3-GN	i5100, i7100	R6400	3000	1
▲	B-494	<b>F N H</b>	48.26	25.40	-	-	-	THT-303-494-3-OR	i5100, i7100	R6400	3000	1
▲	B-494	<b>F N H</b>	48.26	25.40	-	-	-	THT-303-494-3-PK	i5100, i7100	R6400	3000	1
▲	B-494	<b>F N H</b>	48.26	25.40	-	-	-	THT-303-494-3-RD	i5100, i7100	R6400	3000	1
▲	B-494	<b>F N H</b>	48.26	25.40	-	-	-	THT-303-494-3-YL	i5100, i7100	R6400	3000	1
▲	B-492	<b>F N H L</b>	48.26	25.40	-	-	-	THT-156-492-3	BBP12, i7100, i5100	R6400	3000	1
▲	B-492	<b>F N H L</b>	48.26	25.40	-	-	-	THT-156-492-1.5-SC	BBP12	R6400	1500	1
▲	B-490	<b>F N H L</b>	48.26	25.40	-	-	-	THT-156-490-3	BBP12, i7100, i5100	R4300, R7950	3000	1
▲	B-490	<b>F N H L</b>	48.26	25.40	-	-	-	THT-156-490-1.5-SC	BBP12	R7950	1500	1
▲	B-7425J	<b>F N A H</b>	50.80	25.40	-	-	-	J-137-7425J	J7300		1	1
<b>15.0 ml</b>												
▲	B-492	<b>F N H L</b>	25.40	48.26	-	-	-	M6-204-492	M610, M611	R4300, R6400	250	1
▲	B-490	<b>F N H L</b>	55.88	38.10	-	-	-	THT-157-490-3	BBP12, i7100, i5100	R4300, R7950	3000	1
▲	B-490	<b>F N H L</b>	55.88	38.10	-	-	-	THT-157-490-1.5-SC	BBP12	R7950	1500	1
▷	B-461	<b>F N A H S L</b>	63.50	38.10	-	19.05	38.10	M6-157-461	M610, M611	R4300, R6200	100	1
▲	B-7425J	<b>F N A H</b>	76.20	25.40	-	-	-	J-18-7425J	J7300		1	1
▷	B-461	<b>F N A H S L</b>	133.35	25.40	-	38.10	25.40	B33-139-461	i3300	B30 Monocolour Series	650	2
▷	B-461	<b>F N A H S L</b>	133.35	25.40	-	38.10	25.40	THT-139-461-2	BBP12, i7100, i5100	R4300, R7950	2000	2
<b>25.0 ml</b>												
⬢	B-499	<b>F N A</b>	25.40	63.50	-	-	-	B33-325-499	i3300, i5300	B30 Monocolour Series	700	2
▲	B-499	<b>F N A</b>	25.40	63.50	-	-	-	M7-21-499	M710	R4300, R6000HF, R6200	100	1
▲	B-499	<b>F N A</b>	50.80	19.05	-	-	-	M21-137-499	M210-LAB, M211	R4300	1	1
▲	B-423	<b>F A H</b>	50.80	19.05	-	-	-	M21-137-423	M210-LAB, M211	R6000HF	1	1
∞	B-7425J	<b>F N A H</b>	57.15	-	45.72	-	-	JC-2250-7425J	J7300		1	1
<b>50.0 ml</b>												
⬢	B-499	<b>F N A</b>	25.40	101.60	-	-	-	B33-326-499	i3300, i5300	B30 Monocolour Series	450	2
⬢	B-499	<b>F N A</b>	38.10	101.60	-	-	-	B33-327-499	i3300, i5300	B30 Monocolour Series	450	2
⬢	B-499	<b>F N A</b>	38.10	152.40	-	-	-	B33-328-499	i3300, i5300	B30 Monocolour Series	300	2
▲	B-7425J	<b>F N A H</b>	76.20	50.80	-	-	-	J-19-7425J	J7300		1	1
▲	B-7425J	<b>F N A H</b>	88.90	127.00	-	-	-	J-371-7425J	J7300		1	1

**F** Freezer environment    **N** Liquid nitrogen environment    **A** Autoclave environment    **H** Hot water bath (100°C)    **S** Self-laminating label    **L** Low-profile (extremely thin) label    **R** Removable



# Vial top labels



## Vial top labels

Save time by using the Vial and Vial top combination labels - print your information in one go.

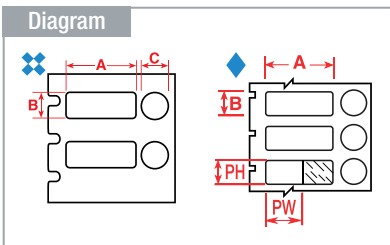

- F** Freezer environment
- N** Liquid nitrogen environment
- A** Autoclave environment
- H** Hot water bath (100°C)
- S** Self-laminating label
- L** Low-profile (extremely thin) label
- R** Removable

The background colours in the Order Reference column represent the material colour.

See page 54 for Brady's range of label printers.

Labels are shown per vial / tube size and in order of label width.

Diagram	Material	Special Properties	Label Width A (mm)	Label Height B (mm)	Diameter C (mm)	Printable Area Width PW (mm)	Printable Area Height PH (mm)	Order Reference	Printer Compatibility	Printer Ribbon Series	Labels per Roll	Labels per Row
<b>0.5 ml</b>												
❖	B-499	<b>F A</b>	22.86	12.70	12.70	-	-	B33-126-499	i3300	B30 Monocolour Series	1500	1
❖	B-490	<b>F H L</b>	22.86	12.70	12.70	-	-	B33-126-490	i3300	B30 Monocolour Series	2500	1
❖	B-499	<b>F A</b>	22.86	12.70	11.18	-	-	M5-117-499	M511, BMP51	R4300	240	-
❖	B-492	<b>F H L</b>	22.86	12.70	11.18	-	-	M5-117-492	M511, BMP51	R6400	240	-
❖	B-492	<b>F H L</b>	22.86	12.70	12.70	-	-	M6-117-492	M610, M611	R4300, R6400	500	1
❖	B-499	<b>F A</b>	22.86	12.70	12.70	-	-	M7-126-499	M710	R4300	500	1
❖	B-499	<b>F A</b>	22.86	12.70	12.70	-	-	THT-126-499-3	i7100, i5100	R4900	3000	1
◆	B-461	<b>F A H S L</b>	25.40	9.53	9.53	20.00	9.53	BPT-606-461	BBP12	R7950	1000	1
◆	B-461	<b>F A H S L</b>	25.40	9.53	9.53	25.40	9.53	B33-606-461	i3300	B30-R4300	1000	1
❖	B-499	<b>F A</b>	25.40	9.53	9.53	25.40	9.53	THT-249-499-1.5-SC	BBP12	R7950, R4300, R4900	1500	1
❖	B-499	<b>F A</b>	25.40	9.53	9.53	-	-	B33-163-499	i3300	B30 Monocolour Series	1500	1
❖	B-492	<b>F H L</b>	25.40	9.53	9.53	-	-	B33-163-492	i3300	B30 Monocolour Series	1500	1
⊕	B-7425J	<b>F N A H</b>	25.40	9.53	-	-	-	J-249-7425J	J7300		1	1
❖	B-7425	<b>F N A H</b>	25.40	9.53	9.53	-	-	M5-118-7425	M511, BMP51	R4300	250	1
❖	B-499	<b>F A</b>	25.40	9.53	9.53	-	-	M5-118-499	M511, BMP51	R4300	240	-
❖	B-492	<b>F H L</b>	25.40	9.53	9.53	-	-	M5-118-492	M511, BMP51	R6400	240	-
❖	B-492	<b>F H L</b>	25.40	9.53	9.53	-	-	M6-98-492	M610, M611	R4300, R6400	500	1
❖	B-499	<b>F A</b>	25.40	9.53	9.53	-	-	M7-98-499	M710	R4300, R6000HF, R6200	500	1
❖	B-492	<b>F H L</b>	25.40	9.53	9.53	-	-	THT-249-492-1.5-SC	BBP12	R6400	1500	1
❖	B-499	<b>F A</b>	25.40	9.53	9.53	-	-	THT-163-499-3	i7100, i5100	R4900	3000	1
❖	B-492	<b>F H L</b>	25.40	9.53	9.53	-	-	THT-163-492-3	BBP12, i7100, i5100	R6400	3000	1
❖	B-492	<b>F H L</b>	25.40	12.70	11.18	-	-	B33-182-492	i3300	B30 Monocolour Series	1500	1
⊕	B-7425J	<b>F N A H</b>	25.40	12.70	-	-	-	J-251-7425J	J7300		1	1
❖	B-499	<b>F A</b>	25.40	12.70	9.53	-	-	M5-120-499	M511, BMP51	R4300	240	-

>>

# Vial top labels

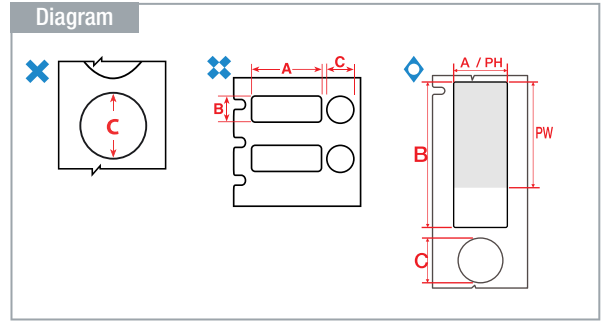

The background colours in the Order Reference column represent the material colour.

See page 54 for Brady's range of label printers.

Labels are shown per vial / tube size and in order of label width.

Diagram	Material	Special Properties	Label Width A (mm)	Label Height B (mm)	Diameter C (mm)	Printable Area Width PW (mm)	Printable Area Height PH (mm)	Order Reference	Printer Compatibility	Printer Ribbon Series	Labels per Roll	Labels per Row
<b>0.5 ml</b>												
✘	B-492	F H L	25.40	12.70	9.53	-	-	M5-120-492	M511, BMP51	R6400	240	-
✘	B-492	F H L	25.40	12.70	9.53	-	-	M6-120-492	M610, M611	R4300, R6400	250	1
✘	B-492	F H L	25.40	12.70	9.53	-	-	M7-118-492	M710	R6400	500	1
✘	B-492	F H L	25.40	12.70	11.18	-	-	THT-251-492-1.5-SC	BBP12	R6400	1500	1
✘	B-492	F H L	25.40	12.70	9.53	-	-	THT-250-492-1.5-SC	BBP12	R6400	1500	1
✘	B-492	F H L	25.40	12.70	11.18	-	-	THT-182-492-3	BBP12, i7100, i5100	R6400	3000	1
✘	B-492	F H L	25.40	12.70	9.53	-	-	THT-181-492-3	i7100, i5100	R6400	3000	1
<b>1.5 ml</b>												
/	B-499	F A	-	-	9.53	-	-	B33-602-499	i3300	B30-R6000	3000	3
/	B-499	F A	-	-	9.53	-	-	B33-602-499YL	i3300	B30-R6000	3000	3
/	B-461	F A H L	-	-	9.53	-	-	B33-602-461AW**	i3300	B30-R4300	3000	3
/	B-499	F A	-	-	9.53	-	-	B33-143-499	i3300	B30 Monocolour Series	1500	4
/	B-492	F H L	-	-	9.53	-	-	B33-143-492	i3300	B30 Monocolour Series	1500	4
/	B-499	F A	-	-	9.53	-	-	BPT-602-499	BBP12	R7950	3000	3
/	B-499	F A	-	-	9.53	-	-	BPT-602-499YL	BBP12	R7950	3000	3
✘	B-461	F A H L	-	-	9.53	-	-	BPT-602-461AW**	BBP12	R7950	3000	3
✘	B-499	F A	-	-	9.53	-	-	M4-82-499	M511, BMP41, BMP51	R4300	240	-
✘	B-499	F A	-	-	9.53	-	-	M4-82-499-OR-BK	M511, BMP41, BMP51	R4300	240	-
✘	B-499	F A	-	-	9.53	-	-	M4-82-499-RD-BK	M511, BMP41, BMP51	R4300	240	-
✘	B-499	F A	-	-	9.53	-	-	M4-82-499-YL-BK	M511, BMP41, BMP51	R4300	240	-
✘	B-492	F H L	-	-	9.53	-	-	M4-82-492	M511, BMP41, BMP51	R6400	240	-
✘	B-499	F A	-	-	9.53	-	-	M7-82-499	M710	R4300, R6000HF, R6200	500	1
/	B-499	F A	-	-	9.53	-	-	THT-143-499-3	BBP12, i7100, i5100	R4900	3000	4
/	B-492	F H L	-	-	9.53	-	-	THT-143-492-3	BBP12, i7100, i5100	R6400	3000	4
/	B-492	F H L	-	-	9.53	-	-	THT-143-492-1.5-SC	BBP12	R6400	1500	4
<b>2.0 ml</b>												
◇	B-494	F N H	25.40	9.53	9.53	-	-	B33-304-494-BL	i3300, i5300	R6400	1500	1
◇	B-494	F N H	25.40	9.53	9.53	-	-	B33-304-494-GN	i3300, i5300	R6400	1500	1
◇	B-494	F N H	25.40	9.53	9.53	-	-	B33-304-494-OR	i3300, i5300	R6400	1500	1
◇	B-494	F N H	25.40	9.53	9.53	-	-	B33-304-494-PK	i3300, i5300	R6400	1500	1
◇	B-494	F N H	25.40	9.53	9.53	-	-	B33-304-494-RD	i3300, i5300	R6400	1500	1
◇	B-494	F N H	25.40	9.53	9.53	-	-	B33-304-494-YL	i3300, i5300	R6400	1500	1
◇	B-494	F N H	25.40	9.53	9.53	-	-	THT-304-494-3-BL	i5100, i7100	R6400	3000	1
◇	B-494	F N H	25.40	9.53	9.53	-	-	THT-304-494-3-GN	i5100, i7100	R6400	3000	1
◇	B-494	F N H	25.40	9.53	9.53	-	-	THT-304-494-3-OR	i5100, i7100	R6400	3000	1
◇	B-494	F N H	25.40	9.53	9.53	-	-	THT-304-494-3-PK	i5100, i7100	R6400	3000	1
◇	B-494	F N H	25.40	9.53	9.53	-	-	THT-304-494-3-RD	i5100, i7100	R6400	3000	1
◇	B-494	F N H	25.40	9.53	9.53	-	-	THT-304-494-3-YL	i5100, i7100	R6400	3000	1

\*\*AW = All White / no transparent area

>>

<b>F</b> Freezer environment	<b>N</b> Liquid nitrogen environment	<b>A</b> Autoclave environment	<b>H</b> Hot water bath (100°C)	<b>S</b> Self-laminating label	<b>L</b> Low-profile (extremely thin) label	<b>R</b> Removable
------------------------------	--------------------------------------	--------------------------------	---------------------------------	--------------------------------	---	--------------------

# Vial top labels

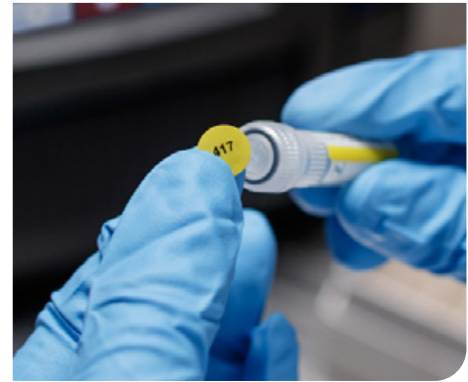
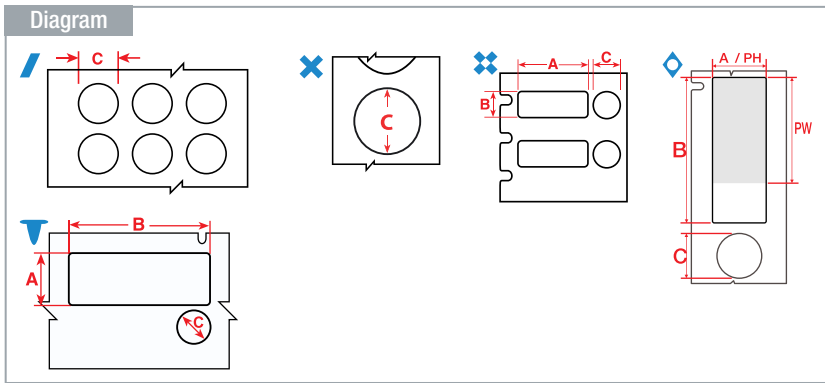

The background colours in the Order Reference column represent the material colour.

See page 54 for Brady's range of label printers.

Labels are shown per vial / tube size and in order of label width.

Diagram	Material	Special Properties	Label Width A (mm)	Label Height B (mm)	Diameter C (mm)	Printable Area Width PW (mm)	Printable Area Height PH (mm)	Order Reference	Printer Compatibility	Printer Ribbon Series	Labels per Roll	Labels per Row
<b>2.0 ml</b>												
◇	B-494	<b>F N H</b>	25.40	12.70	9.53	25.40	9.53	B33-250-494-BL	i3300, i5300	B30 Monocolour Series	1500	1
◇	B-494	<b>F N H</b>	25.40	12.70	9.53	25.40	9.53	B33-250-494-GN	i3300, i5300	B30 Monocolour Series	1500	1
◇	B-494	<b>F N H</b>	25.40	12.70	9.53	25.40	9.53	B33-250-494-OR	i3300, i5300	B30 Monocolour Series	1500	1
◇	B-494	<b>F N H</b>	25.40	12.70	9.53	25.40	9.53	B33-250-494-PK	i3300, i5300	B30 Monocolour Series	1500	1
◇	B-494	<b>F N H</b>	25.40	12.70	9.53	25.40	9.53	B33-250-494-RD	i3300, i5300	B30 Monocolour Series	1500	1
◇	B-494	<b>F N H</b>	25.40	12.70	9.53	25.40	9.53	B33-250-494-YL	i3300, i5300	B30 Monocolour Series	1500	1
⊠	B-494	<b>F N H</b>	25.40	12.70	9.53	25.40	9.53	M5-120-494-BL	M511, BMP51	R6400	240	-
⊠	B-494	<b>F N H</b>	25.40	12.70	9.53	25.40	9.53	M5-120-494-GN	M511, BMP51	R6400	240	-
⊠	B-494	<b>F N H</b>	25.40	12.70	9.53	25.40	9.53	M5-120-494-OR	M511, BMP51	R6400	240	-
⊠	B-494	<b>F N H</b>	25.40	12.70	9.53	25.40	9.53	M5-120-494-PK	M511, BMP51	R6400	240	-
⊠	B-494	<b>F N H</b>	25.40	12.70	9.53	25.40	9.53	M5-120-494-RD	M511, BMP51	R6400	240	-
⊠	B-494	<b>F N H</b>	25.40	12.70	9.53	25.40	9.53	M5-120-494-YL	M511, BMP51	R6400	240	-
◇	B-494	<b>F N H</b>	25.40	12.70	11.18	-	-	THT-306-494-3-BL	i5100, i7100	R6400	3000	1
◇	B-494	<b>F N H</b>	25.40	12.70	11.18	-	-	THT-306-494-3-GN	i5100, i7100	R6400	3000	1
◇	B-494	<b>F N H</b>	25.40	12.70	11.18	-	-	THT-306-494-3-OR	i5100, i7100	R6400	3000	1
◇	B-494	<b>F N H</b>	25.40	12.70	11.18	-	-	THT-306-494-3-PK	i5100, i7100	R6400	3000	1
◇	B-494	<b>F N H</b>	25.40	12.70	11.18	-	-	THT-306-494-3-RD	i5100, i7100	R6400	3000	1
◇	B-494	<b>F N H</b>	25.40	12.70	11.18	-	-	THT-306-494-3-YL	i5100, i7100	R6400	3000	1
◇	B-461	<b>F A H S L</b>	40.00	15.00	9.53	29.97	15.00	M7-101-461	M710	R6200	250	1
/	B-499	<b>F A</b>	-	-	12.70	-	-	B33-603-499	i3300	B30-R6000	3000	3
/	B-499	<b>F A</b>	-	-	12.70	-	-	B33-603-499YL	i3300	B30-R6000	3000	3
/	B-499	<b>F A</b>	-	-	12.70	-	-	B33-144-499	i3300	B30 Monocolour Series	1500	3
/	B-492	<b>F H L</b>	-	-	12.70	-	-	B33-144-492	i3300	B30 Monocolour Series	1500	3
/	B-490	<b>F H L</b>	-	-	12.70	-	-	B33-144-490	i3300	B30 Monocolour Series	2500	3
/	B-499	<b>F A</b>	-	-	12.70	-	-	BPT-603-499	BBP12	R7950	3000	3
/	B-499	<b>F A</b>	-	-	12.70	-	-	BPT-603-499YL	BBP12	R7950	3000	3
⊠	B-499	<b>F A</b>	-	-	12.70	-	-	M4-83-499	M511, BMP41, BMP51	R4300	240	-
⊠	B-499	<b>F A</b>	-	-	12.70	-	-	M4-83-499-OR-BK	M511, BMP41, BMP51	R4300	240	-
⊠	B-499	<b>F A</b>	-	-	12.70	-	-	M4-83-499-RD-BK	M511, BMP41, BMP51	R4300	240	-
⊠	B-499	<b>F A</b>	-	-	12.70	-	-	M4-83-499-YL-BK	M511, BMP41, BMP51	R4300	240	-
⊠	B-492	<b>F H L</b>	-	-	12.70	-	-	M4-83-492	M511, BMP41, BMP51	R6400	240	-
⊠	B-499	<b>F A</b>	-	-	12.70	-	-	M7-83-499	M710	R4300, R6000HF, R6200	500	1
/	B-499	<b>F A</b>	-	-	12.70	-	-	THT-144-499-3	BBP12, i7100, i5100	R4900	3000	3
/	B-499	<b>F A</b>	-	-	12.70	-	-	THT-144-499-1.5-SC	BBP12	R7950, R4300, R4900	1500	3
/	B-492	<b>F H L</b>	-	-	12.70	-	-	THT-144-492-3	BBP12, i7100, i5100	R6400	3000	3
/	B-492	<b>F H L</b>	-	-	12.70	-	-	THT-144-492-1.5-SC	BBP12	R6400	1500	3

>>

**F** Freezer environment    **N** Liquid nitrogen environment    **A** Autoclave environment    **H** Hot water bath (100°C)    **S** Self-laminating label    **L** Low-profile (extremely thin) label    **R** Removable

# Vial top labels

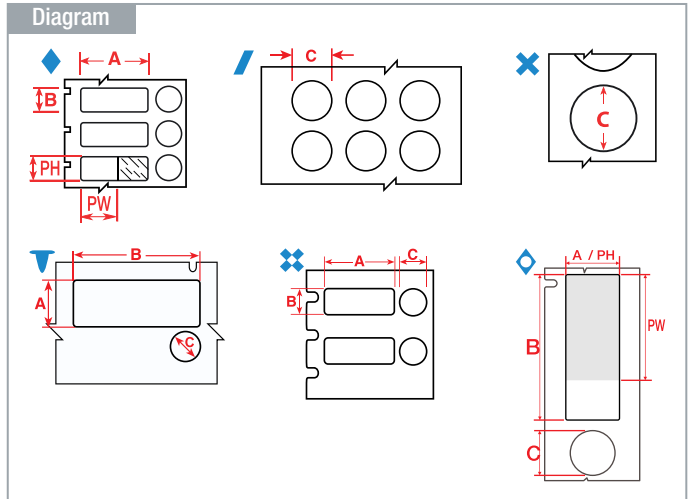

Labels are shown per vial / tube size and in order of label width.

The background colours in the Order Reference column represent the material colour.

See page 54 for Brady's range of label printers.

Diagram	Material	Special Properties	Label Width A (mm)	Label Height B (mm)	Diameter C (mm)	Printable Area Width PW (mm)	Printable Area Height PH (mm)	Order Reference	Printer Compatibility	Printer Ribbon Series	Labels per Roll	Labels per Row
<b>4.0 ml</b>												
◇	B-461	F AHS L	15.24	41.28	12.70	15.24	30.00	M7-116-461	M710	R6200	150	1
◇	B-461	F AHS L	40.00	15.00	9.00	40.00	15.00	BPTLAB-20-461-2.5	BBP12	R7950	2500	1
○	B-461	F AHS L	41.28	15.24	12.70	41.28	15.24	B33-608-461	i3300	B30-R4300	1000	1
◇	B-461	F AHS L	41.28	15.24	12.70	41.28	15.24	BPT-608-461	BBP12	R7950	1000	1
⊠	B-492	F H L	41.28	15.24	9.53	-	-	B33-190-492	i3300	B30 Monocolour Series	1500	1
⊠	B-499	F A	41.28	15.24	12.70	-	-	BPT-608-499	BBP12	R7950	1000	1
▽	B-492	F H L	41.28	15.24	9.53	-	-	M5-95-492	M511, BMP51	R6400	200	-
⊠	B-492	F H L	41.28	15.24	9.53	-	-	THT-190-492-3	BBP12, i7100, i5100	R6400	3000	1
<b>8.0 ml</b>												
⊠	B-494	F N H	25.40	9.53	9.53	25.40	6.35	M5-118-494-BL	M511, BMP51	R6400	240	-
⊠	B-494	F N H	25.40	9.53	9.53	25.40	6.35	M5-118-494-GN	M511, BMP51	R6400	240	-
⊠	B-494	F N H	25.40	9.53	9.53	25.40	6.35	M5-118-494-OR	M511, BMP51	R6400	240	-
⊠	B-494	F N H	25.40	9.53	9.53	25.40	6.35	M5-118-494-PK	M511, BMP51	R6400	240	-
⊠	B-494	F N H	25.40	9.53	9.53	25.40	6.35	M5-118-494-RD	M511, BMP51	R6400	240	-
⊠	B-494	F N H	25.40	9.53	9.53	25.40	6.35	M5-118-494-YL	M511, BMP51	R6400	240	1
◇	B-494	F N H	25.40	9.53	9.53	25.40	6.35	M6-98-494-BL	M611, M610	R6400	500	1
◇	B-494	F N H	25.40	9.53	9.53	25.40	6.35	M6-98-494-GN	M611, M610	R6400	500	1
◇	B-494	F N H	25.40	9.53	9.53	25.40	6.35	M6-98-494-OR	M611, M610	R6400	500	1
◇	B-494	F N H	25.40	9.53	9.53	25.40	6.35	M6-98-494-PK	M611, M610	R6400	500	1
◇	B-494	F N H	25.40	9.53	9.53	25.40	6.35	M6-98-494-RD	M611, M610	R6400	500	1
◇	B-494	F N H	25.40	9.53	9.53	25.40	6.35	M6-98-494-YL	M611, M610	R6400	500	1
<b>15.0 ml</b>												
/	B-461	F AH L	-	-	15.24	-	-	B33-604-461AW**	i3300	B30-R4300	3000	3
⊠	B-461	F AH L	-	-	15.24	-	-	BPT-604-461AW**	BBP12	R7950	3000	3

\*\*AW = All White / no transparent area

<b>F</b> Freezer environment	<b>N</b> Liquid nitrogen environment	<b>A</b> Autoclave environment	<b>H</b> Hot water bath (100°C)	<b>S</b> Self-laminating label	<b>L</b> Low-profile (extremely thin) label	<b>R</b> Removable
------------------------------	--------------------------------------	--------------------------------	---------------------------------	--------------------------------	---	--------------------

# Centrifuge, Eppendorf and PCR Labels

- F** Freezer environment
- N** Liquid nitrogen environment
- A** Autoclave environment
- H** Hot water bath (100°C)
- S** Self-laminating label
- L** Low-profile (extremely thin) label
- R** Removable

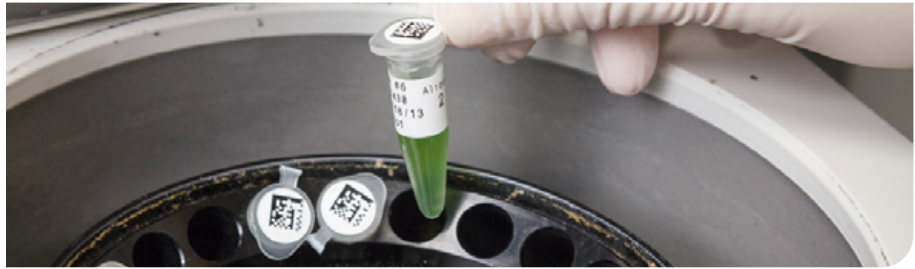

## Centrifuge, Eppendorf and PCR Labels

Brady offers a wide range of Centrifuge, Eppendorf and PCR Labels.

When applying a self-laminating label, we recommend you avoid touching the adhesive side of the label when wrapping it around a vial or tube, to ensure maximum adhesion.

Diagram

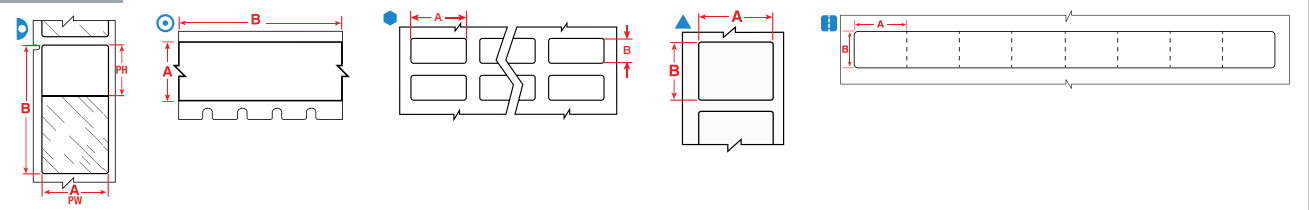

The background colours in the Order Reference column represent the material colour.

See page 54 for Brady's range of label printers.

Labels are shown per vial / tube size and in order of label width.

Diagram	Material	Special Properties	Label Width A (mm)	Label Height B (mm)	Label Length B (m)	Diameter C (mm)	Printable Area Width PW (mm)	Printable Area Height PH (mm)	Order Reference	Printer Compatibility	Printer Ribbon Series	Labels per Roll	Labels per Row
▶	B-461	<b>FNAHSL</b>	5.08	22.86	-	-	5.08	18.03	BPT-614-461	BBP12	R7950	2000	1
▶	B-461	<b>FNAHSL</b>	5.08	22.86	-	-	5.08	18.29	B33-614-461	i3300	B30-R4300	2000	1
▶	B-461	<b>FNAHSL</b>	6.35	27.94	-	-	6.35	22.09	B33-627-461	i3300	B30-R4300	1000	1
▶	B-461	<b>FNAHSL</b>	6.35	27.94	-	-	6.35	22.09	BPT-627-461	BBP12	R7950	1000	1
⊙	B-423	<b>F AH</b>	6.35	-	6.40	-	-	-	M21-250-423	M210-LAB, M211	R6200	1	-
!	B-492	<b>F H L</b>	9.50	6.35	-	-	-	-	B33-289-492-WT	i3300, i5300	R6400	1500	8
!	B-492	<b>F H L</b>	9.50	6.35	-	-	-	-	THT-289-492-2-WT	BBP12, i7100, i5100	R6400	2000	8
▶	B-461	<b>FNAHSL</b>	9.53	45.72	-	-	9.53	19.05	M7-73-461	M710	R6200	250	1
⊙	B-499	<b>FNA</b>	9.53	-	4.88	-	-	-	M4C-375-499	M511, BMP41, BMP51	R4300	1	-
⊙	B-499	<b>FNA</b>	9.53	-	4.88	-	-	-	M21-375-499	M210-LAB, M211	R4300	1	-
⊙	B-461	<b>FNAHSL</b>	9.53	-	6.40	-	-	-	M21-375-461-AW**	M210-LAB, M211	R4300	1	-
⊙	B-461	<b>FNAHSL</b>	9.53	-	7.62	-	-	-	M4C-375-461	M511, BMP41, BMP51	R4300	1	-
⊙	B-461	<b>FNAHSL</b>	9.53	-	15.24	-	-	-	M6C-375-461	M610, M611	R4300, R6200	1	1
▶	B-499	<b>FNA</b>	12.70	19.05	-	-	-	-	B33-68-499	i3300	B30 Monocolour Series	1500	4
▶	B-490	<b>FNAHSL</b>	12.70	19.05	-	-	-	-	B33-68-490	i3300	B30 Monocolour Series	2500	4
▶	B-499	<b>FNA</b>	12.70	19.05	-	-	-	-	M7-11-499	M710	R4300, R6000HF, R6200	500	1
▶	B-499	<b>FNA</b>	12.70	19.05	-	-	-	-	THT-68-499-10	BBP12, i7100, i5100	R4900	10000	4
⊙	B-499	<b>FNA</b>	12.70	-	4.88	-	-	-	M4C-500-499	M511, BMP41, BMP51	R4300	1	-
⊙	B-499	<b>FNA</b>	12.70	-	4.88	-	-	-	M21-500-499	M210-LAB, M211	R4300	1	-
⊙	B-461	<b>FNAHSL</b>	12.70	-	6.40	-	-	-	M21-500-461-AW**	M210-LAB, M211	R4300	1	-
⊙	B-492	<b>FNHL</b>	12.70	-	7.62	-	-	-	M4C-500-492	M511, BMP51, BMP41	R6400	1	-
⊙	B-461	<b>FNAHSL</b>	12.70	-	7.62	-	-	-	M4C-500-461	M511, BMP41, BMP51	R4300	1	-
⊙	B-499	<b>FNA</b>	12.70	-	9.14	-	-	-	M7C-500-499	M710	R4300, R6000HF, R6200	1	1
⊙	B-461	<b>FNAHSL</b>	12.70	-	15.24	-	-	-	M6C-500-461	M610, M611	R4300, R6200	1	1
▶	B-499	<b>FNA</b>	19.05	12.70	-	-	-	-	BM-11-499	M610, M611, M710	R4300, R6000HF, R6200	5000	1
▶	B-499	<b>FNA</b>	19.05	12.70	-	-	-	-	M4-11-499	M511, BMP41, BMP51	R4300	220	-
▶	B-499	<b>FNA</b>	19.05	12.70	-	-	-	-	M6-11-499	M610, M611	R4300, R6200	500	1
▶	B-499	<b>FNA</b>	19.05	12.70	-	-	-	-	M21-11-499	M210-LAB, M211	R4300	1	1
▶	B-499	<b>FNA</b>	20.96	9.53	-	-	-	-	M4-130-499	M511, BMP41, BMP51	R4300	220	-
▶	B-492	<b>FNHL</b>	20.96	9.53	-	-	-	-	M4-130-492	M511, BMP41, BMP51	R6400	220	-
▶	B-492	<b>FNHL</b>	20.96	9.53	-	-	-	-	M6-130-492	M610, M611	R4300, R6400	500	1
✘	B-499	<b>FA</b>	22.86	12.70	-	11.18	-	-	M5-117-499	M511, BMP51	R4300	240	-

\*\*AW = All White / no transparent area



# Centrifuge, Eppendorf and PCR Labels

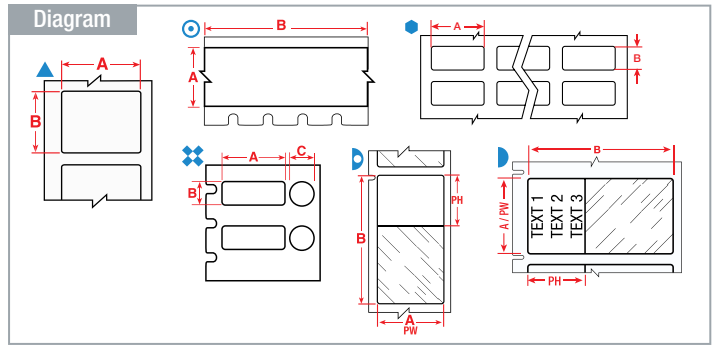

The background colours in the Order Reference column represent the material colour.

See page 54 for Brady's range of label printers.

Labels are shown per vial / tube size and in order of label width.

Diagram	Material	Special Properties	Label Width A (mm)	Label Height B (mm)	Label Length B (m)	Diameter C (mm)	Printable Area Width PW (mm)	Printable Area Height PH (mm)	Order Reference	Printer Compatibility	Printer Ribbon Series	Labels per Roll	Labels per Row
<b>0.5 ml</b>													
⊗	B-492	F H L	22.86	12.70	-	11.18	-	-	M5-117-492	M511, BMP51	R6400	240	-
▲	B-499	F N A	22.86	12.70	-	-	-	-	M5-84-499	M511, BMP51	R4300	200	-
⊗	B-499	F A	22.86	12.70	-	12.70	-	-	M6-117-499	M610, M611	R4300, R6200	500	1
⊗	B-499	F A	22.86	12.70	-	12.70	-	-	M7-126-499	M710	R4300	500	1
▲	B-499	F N A	22.86	12.70	-	-	-	-	M7-84-499	M710	R4300, R6000HF, R6200	500	1
⊗	B-499	F A	22.86	12.70	-	12.70	-	-	THT-126-499-3	i7100, i5100	R4900	3000	1
●	B-499	F N A	25.40	9.53	-	-	-	-	B33-152-499	i3300	B30 Monocolour Series	1500	2
●	B-492	F N H L	25.40	9.53	-	-	-	-	B33-152-492	i3300	B30 Monocolour Series	2500	2
⊕	B-7425J	F N A H	25.40	9.53	-	-	-	-	J-249-7425J	J7300		1	1
▲	B-7425J	F N A H	25.40	9.53	-	-	-	-	J-152-7425J	J7300		1	2
⊗	B-7425	F N A H	25.40	9.53	-	9.53	-	-	M5-118-7425	M511, BMP51	R4300	250	1
⊗	B-499	F A	25.40	9.53	-	9.53	-	-	M5-118-499	M511, BMP51	R4300	240	-
⊗	B-492	F H L	25.40	9.53	-	9.53	-	-	M5-118-492	M511, BMP51	R6400	240	-
⊗	B-499	F A	25.40	9.53	-	9.53	-	-	M6-98-499	M610, M611	R4300, R6200	500	1
▲	B-499	F N A	25.40	9.53	-	-	-	-	M6-16-499	M610, M611	R4300, R6200	500	1
⊗	B-499	F A	25.40	9.53	-	9.53	-	-	M7-98-499	M710	R4300, R6000HF, R6200	500	1
▲	B-499	F N A	25.40	9.53	-	-	-	-	M7-16-499	M710	R4300, R6000HF, R6200	500	1
▲	B-492	F N H L	25.40	9.53	-	-	-	-	M7-16-492	M710	R6400	500	1
●	B-499	F N A	25.40	9.53	-	-	-	-	THT-152-499-3	BBP12, i7100, i5100	R4900	3000	2
●	B-499	F N A	25.40	9.53	-	-	-	-	THT-152-499-1.5-SC	BBP12	R7950, R4300, R4900	1500	2
●	B-492	F N H L	25.40	9.53	-	-	-	-	THT-152-492-3	BBP12, i7100, i5100	R6400	3000	2
●	B-492	F N H L	25.40	9.53	-	-	-	-	THT-152-492-2.5-SC	BBP12	R6400	2500	2
▲	B-492	F N H L	25.40	12.70	-	-	-	-	B33-59-492	i3300	B30 Monocolour Series	2500	1
⊕	B-7425J	F N A H	25.40	12.70	-	-	-	-	J-251-7425J	J7300		1	1
▲	B-7425J	F N A H	25.40	12.70	-	-	-	-	J-59-7425J	J7300		1	1
▲	B-499	F N A	25.40	12.70	-	-	-	-	M4-131-499	M511, BMP41, BMP51	R4300	180	-
▲	B-492	F N H L	25.40	12.70	-	-	-	-	M4-131-492	M511, BMP41, BMP51	R6400	180	-
⊗	B-499	F A	25.40	12.70	-	9.53	-	-	M5-120-499	M511, BMP51	R4300	240	-
⊗	B-492	F H L	25.40	12.70	-	9.53	-	-	M5-120-492	M511, BMP51	R6400	240	-
▲	B-492	F N H L	25.40	12.70	-	-	-	-	M6-17-492	M610, M611	R4300, R6400	500	1
▲	B-499	F N A	25.40	12.70	-	-	-	-	M21-131-499	M210-LAB, M211	R4300	1	1
▲	B-423	F A H	25.40	12.70	-	-	-	-	M21-17-423	M210-LAB, M211	R6000HF	1	1
▲	B-492	F N H L	25.40	12.70	-	-	-	-	THT-59-492-10	BBP12, i7100, i5100	R6400	10000	1
▲	B-492	F N H L	25.40	12.70	-	-	-	-	THT-59-492-2.5-SC	BBP12	R6400	2500	1
▷	B-461	F N A H S L	28.58	12.70	-	-	19.05	12.70	M5-122-461	M511, BMP51	R4300	360	-
▷	B-461	F N A H S L	28.58	12.70	-	-	19.05	12.70	M6-122-461	M610, M611	R4300, R6200	500	1
▷	B-461	F N A H S L	38.10	4.75	-	-	17.78	4.75	M6-108-461	M610, M611	R4300, R6200	750	1
▷	B-461	F N A H S L	41.91	12.70	-	-	19.05	12.70	M4-124-461	M511, BMP41, BMP51	R4300	180	-
▷	B-461	F N A H S L	41.91	12.70	-	-	19.05	12.70	M6-202-461	M610, M611	R4300, R6200	500	1
▷	B-461	F N A H S L	44.45	12.70	-	-	19.05	12.70	M4-72-461	M511, BMP41, BMP51	R4300	180	-
▷	B-461	F N A H S L	45.72	12.70	-	-	19.05	12.70	B33-122-461	i3300	B30 Monocolour Series	1500	1
▷	B-461	F N A H S L	45.72	12.70	-	-	19.05	12.70	M6-72-461	M610, M611	R4300, R6200	500	1
▷	B-461	F N A H S L	45.72	12.70	-	-	19.05	12.70	THT-122-461-3*	BBP12, i7100, i5100	R4300, R7950	3000	1

>>

**F** Freezer environment    **N** Liquid nitrogen environment    **A** Autoclave environment    **H** Hot water bath (100°C)    **S** Self-laminating label    **L** Low-profile (extremely thin) label    **R** Removable

# Centrifuge, Eppendorf and PCR Labels

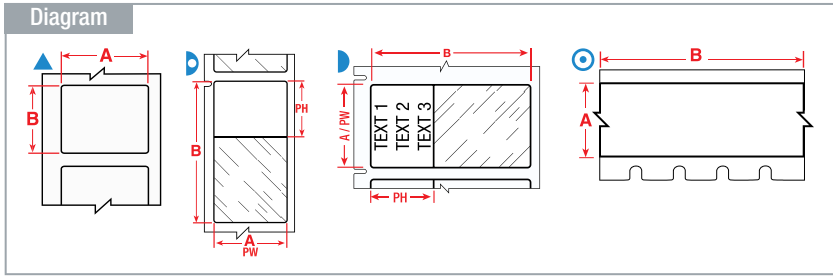

The background colours in the Order Reference column represent the material colour.

See page 54 for Brady's range of label printers.

Labels are shown per vial / tube size and in order of label width.

Diagram	Material	Special Properties	Label Width A (mm)	Label Height B (mm)	Label Length B (m)	Diameter C (mm)	Printable Area Width PW (mm)	Printable Area Height PH (mm)	Order Reference	Printer Compatibility	Printer Ribbon Series	Labels per Roll	Labels per Row
<b>0.5 ml</b>													
▶	B-461	<b>FNAHSL</b>	45.72	12.70	-	-	19.05	12.70	THT-122-461-1.5-SC*	BBP12	R7950	1500	1
▶	B-461	<b>FNAHSL</b>	55.88	12.70	-	-	19.05	12.70	M4-74-461	M511, BMP41, BMP51	R4300	140	-
▶	B-461	<b>FNAHSL</b>	55.88	12.70	-	-	19.05	12.70	M6-74-461	M610, M611	R4300, R6200	100	1
▶	B-461	<b>FNAHSL</b>	55.88	12.70	-	-	19.05	12.70	THT-127-461-3*	BBP12, i7100, i5100	R4300, R7950	3000	1
▶	B-461	<b>FNAHSL</b>	55.88	12.70	-	-	19.05	12.70	THT-127-461-1.5-SC*	BBP12	R7950	1500	1
<b>1.5 ml</b>													
▶	B-461	<b>FNAHSL</b>	15.24	41.28	-	-	15.24	25.40	M7-76-461	M710	R4300, R6200, R6900	500	1
○	B-499	<b>FNA</b>	19.05	-	4.88	-	-	-	M4C-750-499	M511, BMP41, BMP51	R4300	1	-
○	B-499	<b>FNA</b>	19.05	-	4.88	-	-	-	M21-750-499	M210-LAB, M211	R4300	1	-
○	B-461	<b>FNAHSL</b>	19.05	-	6.40	-	-	-	M21-750-461-AW**	M210-LAB, M211	R4300	1	-
●	B-7425J	<b>FNAH</b>	25.40	19.05	-	-	-	-	J-88-7425J	J7300		1	2
▲	B-499	<b>FNA</b>	25.40	19.05	-	-	-	-	M21-18-499	M210-LAB, M211	R4300	1	1
▲	B-423	<b>F AH</b>	25.40	19.05	-	-	-	-	M21-18-423	M210-LAB, M211	R6000HF	1	1
▶	B-461	<b>FNAHSL</b>	28.58	9.53	-	-	19.05	9.53	M5-123-461	M511, BMP51	R4300	360	-
▶	B-461	<b>FNAHSL</b>	28.58	9.53	-	-	19.05	9.53	M6-123-461	M610, M611	R4300, R6200	500	1
▲	B-490	<b>FN H L</b>	31.75	9.53	-	-	-	-	B33-154-490	i3300	B30 Monocolour Series	1500	1
▲	B-492	<b>FN H L</b>	31.75	9.53	-	-	-	-	M5-112-492	M511, BMP51	R6400	360	-
▲	B-490	<b>FN H L</b>	31.75	9.53	-	-	-	-	M5-112-490	M511, BMP51	R4300	360	-
▲	B-490	<b>FN H L</b>	31.75	9.53	-	-	-	-	M6-112-490	M610, M611	R4300	500	1
▲	B-490	<b>FN H L</b>	31.75	9.53	-	-	-	-	THT-154-490-3	BBP12, i7100, i5100	R4300	3000	1
▲	B-490	<b>FN H L</b>	31.75	9.53	-	-	-	-	THT-154-490-1.5-SC	BBP12	R7950	1500	1
▶	B-461	<b>FNAHSL</b>	41.28	15.24	-	-	25.40	15.24	M6-76-461	M610, M611	R4300, R6200	250	1
▶	B-461	<b>FNAHSL</b>	45.72	9.53	-	-	19.05	9.53	B33-123-461	i3300	B30 Monocolour Series	1500	1
▶	B-461	<b>FNAHSL</b>	45.72	9.53	-	-	19.05	9.53	M6-73-461	M610, M611	R4300, R6200	500	1
▶	B-461	<b>FNAHSL</b>	45.72	9.53	-	-	19.05	9.53	THT-123-461-3	BBP12, i7100, i5100	R4300, R7950	3000	1
▶	B-461	<b>FNAHSL</b>	45.72	9.53	-	-	19.05	9.53	THT-123-461-1.5-SC*	BBP12	R7950	1500	1
▶	B-461	<b>FNAHSL</b>	45.72	15.24	-	-	25.40	15.24	M4-126-461	M511, BMP41, BMP51	R4300	180	-
▶	B-461	<b>FNAHSL</b>	45.72	15.24	-	-	25.40	15.24	M6-201-461	M610, M611	R4300, R6200	100	1
▶	B-461	<b>FNAHSL</b>	66.68	15.24	-	-	25.40	15.24	B33-153-461	i3300	B30 Monocolour Series	1500	1
▶	B-461	<b>FNAHSL</b>	66.68	15.24	-	-	25.40	15.24	M4-86-461	M511, BMP41, BMP51	R4300	120	-
▶	B-461	<b>FNAHSL</b>	66.68	15.24	-	-	25.40	15.24	THT-153-461-3*	BBP12, i7100, i5100	R4300, R7950	3000	1
▶	B-461	<b>FNAHSL</b>	66.68	15.24	-	-	25.40	15.24	THT-153-461-1.5-SC*	BBP12	R7950	1500	1
<b>2.0 ml</b>													
▲	B-492	<b>FN H L</b>	22.86	25.40	-	-	-	-	M6-156-492	M610, M611	R4300, R6400	250	1
▲	B-494	<b>FN H</b>	25.40	12.70	-	-	-	-	B33-310-494-BL	i3300, i5300	R6400	2500	1
▲	B-494	<b>FN H</b>	25.40	12.70	-	-	-	-	B33-310-494-GN	i3300, i5300	R6400	2500	1
▲	B-494	<b>FN H</b>	25.40	12.70	-	-	-	-	B33-310-494-OR	i3300, i5300	R6400	2500	1
▲	B-494	<b>FN H</b>	25.40	12.70	-	-	-	-	B33-310-494-PK	i3300, i5300	R6400	2500	1
▲	B-494	<b>FN H</b>	25.40	12.70	-	-	-	-	B33-310-494-RD	i3300, i5300	R6400	2500	1
▲	B-494	<b>FN H</b>	25.40	12.70	-	-	-	-	B33-310-494-YL	i3300, i5300	R6400	2500	1
▲	B-494	<b>FN H</b>	25.40	12.70	-	-	-	-	BPT-310-494-2.5-BL	BBP12	R6400	2500	1
▲	B-494	<b>FN H</b>	25.40	12.70	-	-	-	-	BPT-310-494-2.5-GN	BBP12	R6400	2500	1

\*Label is rotated 90° on liner.

\*\*AW = All White / no transparent area

>>

**F** Freezer environment    **N** Liquid nitrogen environment    **A** Autoclave environment    **H** Hot water bath (100°C)    **S** Self-laminating label    **L** Low-profile (extremely thin) label    **R** Removable

# Centrifuge, Eppendorf and PCR Labels

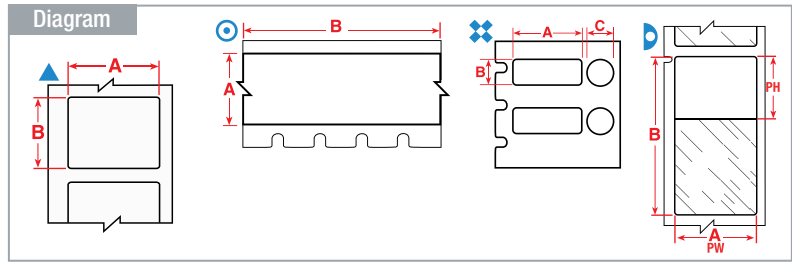

The background colours in the Order Reference column represent the material colour.

See page 54 for Brady's range of label printers.

Labels are shown per vial / tube size and in order of label width.

Diagram	Material	Special Properties	Label Width A (mm)	Label Height B (mm)	Label Length B (m)	Diameter C (mm)	Printable Area Width PW (mm)	Printable Area Height PH (mm)	Order Reference	Printer Compatibility	Printer Ribbon Series	Labels per Roll	Labels per Row
<b>2.0 ml</b>													
▲	B-494	<b>F N H</b>	25.40	12.70	-	-	-	-	BPT-310-494-2.5-OR	BBP12	R6400	2500	1
▲	B-494	<b>F N H</b>	25.40	12.70	-	-	-	-	BPT-310-494-2.5-PK	BBP12	R6400	2500	1
▲	B-494	<b>F N H</b>	25.40	12.70	-	-	-	-	BPT-310-494-2.5-RD	BBP12	R6400	2500	1
▲	B-494	<b>F N H</b>	25.40	12.70	-	-	-	-	BPT-310-494-2.5-YL	BBP12	R6400	2500	1
▲	B-494	<b>F N H</b>	25.40	12.70	-	-	-	-	THT-310-494-10-BL	i5100, i7100	R6400	10000	1
▲	B-494	<b>F N H</b>	25.40	12.70	-	-	-	-	THT-310-494-10-GN	i5100, i7100	R6400	10000	1
▲	B-494	<b>F N H</b>	25.40	12.70	-	-	-	-	THT-310-494-10-OR	i5100, i7100	R6400	10000	1
▲	B-494	<b>F N H</b>	25.40	12.70	-	-	-	-	THT-310-494-10-PK	i5100, i7100	R6400	10000	1
▲	B-494	<b>F N H</b>	25.40	12.70	-	-	-	-	THT-310-494-10-RD	i5100, i7100	R6400	10000	1
▲	B-494	<b>F N H</b>	25.40	12.70	-	-	-	-	THT-310-494-10-YL	i5100, i7100	R6400	10000	1
▲	B-7425J	<b>F N A H</b>	25.40	25.40	-	-	-	-	J-179-7425J	J7300		1	1
▲	B-492	<b>F N H L</b>	25.40	25.40	-	-	-	-	M6-19-492	M610, M611	R4300, R6400	250	1
○	B-499	<b>F N A</b>	25.40	-	4.88	-	-	-	M5C-1000-499	M511, BMP51	R4300	1	-
○	B-7425	<b>F N A H</b>	25.40	-	7.62	-	-	-	M4C-1000-7425	M410, M510, M511	R4300	1	-
○	B-423	<b>F A H</b>	25.40	-	7.62	-	-	-	M4C-1000-423	M410, M510, M511	R6200	1	-
○	B-499	<b>F N A</b>	25.40	-	9.14	-	-	-	M7C-1000-499	M710	R4300, R6000HF, R6200	1	1
▲	B-492	<b>F N H L</b>	31.75	6.35	-	-	-	-	M5-155-492	M511, BMP51	R6400	180	-
▲	B-7425J	<b>F N A H</b>	33.02	15.24	-	-	-	-	J-256-7425J	J7300		1	1
▶	B-461	<b>F N A H S L</b>	44.45	25.40	-	-	25.40	25.40	M6-203-461	M610, M611	R4300, R6200	100	1
<b>4.0 ml</b>													
▲	B-490	<b>F N H L</b>	12.70	41.91	-	-	-	-	M4-124-490	M511, BMP41, BMP51	R4300	180	-
▲	B-492	<b>F N H L</b>	12.70	41.91	-	-	-	-	M5-124-492	M511, BMP51	R6400	180	-
▲	B-492	<b>F N H L</b>	12.70	41.91	-	-	-	-	M6-124-492	M610, M611	R4300, R6400	500	1
⊗	B-492	<b>F H L</b>	15.24	41.28	-	9.53	-	-	M6-205-492	M610, M611	R4300, R6400	250	1
∞	B-7425J	<b>F N A H</b>	28.58	-	45.72	-	-	-	JC-1125-7425J	J7300		1	1
▲	B-7425J	<b>F N A H</b>	38.10	19.05	-	-	-	-	J-136-7425J	J7300		1	1
▲	B-7425J	<b>F N A H</b>	38.10	25.40	-	-	-	-	J-235-7425J	J7300		1	1
▲	B-7425	<b>F N A H</b>	38.10	25.40	-	-	-	-	M5-31-7425	M511, BMP51	R4300	250	1
▲	B-7425J	<b>F N A H</b>	38.10	44.45	-	-	-	-	J-258-7425J	J7300		1	1
○	B-7425	<b>F N A H</b>	38.10	-	7.62	-	-	-	M5C-1500-7425	M510, M511	R4300	1	-
▶	B-461	<b>F N A H S L</b>	41.28	15.24	-	-	25.40	15.24	THT-133-461-3*	BBP12, i7100, i5100	R4300, R7950	3000	1
▶	B-461	<b>F N A H S L</b>	41.28	15.24	-	-	25.40	15.24	THT-133-461-1.5-SC*	BBP12	R7950	1500	1
▲	B-492	<b>F N H L</b>	41.28	15.24	-	-	-	-	B33-155-492	i3300	B30 Monocolour Series	1500	1
▲	B-490	<b>F N H L</b>	41.28	15.24	-	-	-	-	B33-155-490	i3300	B30 Monocolour Series	1500	1
▲	B-490	<b>F N H L</b>	41.28	15.24	-	-	-	-	M6-76-490	M610, M611	R4300	250	1
▲	B-490	<b>F N H L</b>	41.28	15.24	-	-	-	-	M7-76-490	M710	R4300	500	1
▲	B-492	<b>F N H L</b>	41.28	15.24	-	-	-	-	THT-155-492-3	BBP12, i7100, i5100	R6400	3000	1
▲	B-490	<b>F N H L</b>	41.28	15.24	-	-	-	-	THT-155-490-3	BBP12, i7100, i5100	R4300, R7950	3000	1
▲	B-490	<b>F N H L</b>	41.28	15.24	-	-	-	-	THT-155-490-1.5-SC	BBP12	R7950	1500	1
○	B-499	<b>F N A</b>	48.26	-	9.14	-	-	-	M7C-1900-499	M710	R4300, R6000HF, R6200	1	1

\*Label is rotated 90° on liner.

>>

<b>F</b> Freezer environment	<b>N</b> Liquid nitrogen environment	<b>A</b> Autoclave environment	<b>H</b> Hot water bath (100°C)	<b>S</b> Self-laminating label	<b>L</b> Low-profile (extremely thin) label	<b>R</b> Removable
------------------------------	--------------------------------------	--------------------------------	---------------------------------	--------------------------------	---	--------------------



# Centrifuge, Eppendorf and PCR Labels

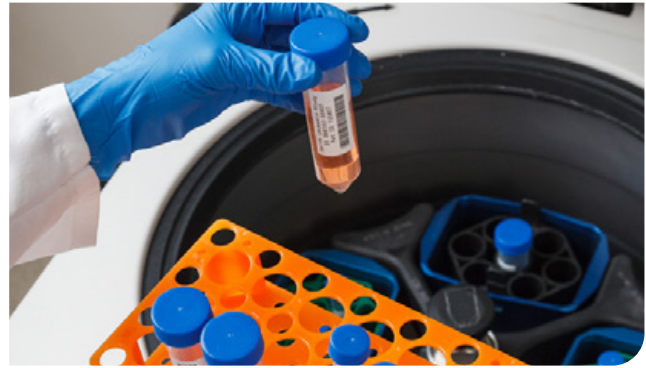
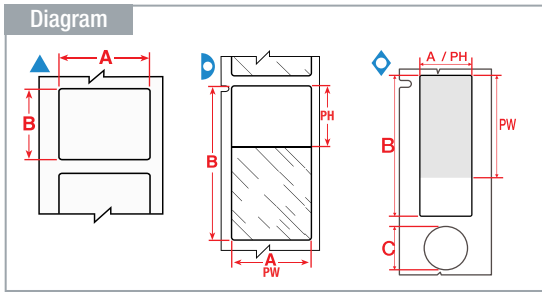

Labels are shown per vial / tube size and in order of label width.

The background colours in the Order Reference column represent the material colour.

See page 54 for Brady's range of label printers.

Diagram	Material	Special Properties	Label Width A (mm)	Label Height B (mm)	Label Length B (m)	Diameter C (mm)	Printable Area Width PW (mm)	Printable Area Height PH (mm)	Order Reference	Printer Compatibility	Printer Ribbon Series	Labels per Roll	Labels per Row
<b>8.0 ml</b>													
▷	B-461	<b>FNAHSL</b>	15.24	66.68	-	-	15.24	25.40	M7-86-461	M710	R6200	100	1
▷	B-461	<b>FNAHSL</b>	15.24	66.68	-	-	25.40	15.24	M6-86-461	M610, M611	R4300, R6200	100	1
◇	B-494	<b>FNH</b>	25.40	9.53	-	9.53	25.40	6.35	M6-98-494-BL	M611, M610	R6400	500	1
◇	B-494	<b>FNH</b>	25.40	9.53	-	9.53	25.40	6.35	M6-98-494-GN	M611, M610	R6400	500	1
◇	B-494	<b>FNH</b>	25.40	9.53	-	9.53	25.40	6.35	M6-98-494-OR	M611, M610	R6400	500	1
◇	B-494	<b>FNH</b>	25.40	9.53	-	9.53	25.40	6.35	M6-98-494-PK	M611, M610	R6400	500	1
◇	B-494	<b>FNH</b>	25.40	9.53	-	9.53	25.40	6.35	M6-98-494-RD	M611, M610	R6400	500	1
◇	B-494	<b>FNH</b>	25.40	9.53	-	9.53	25.40	6.35	M6-98-494-YL	M611, M610	R6400	500	1
▲	B-494	<b>FNH</b>	25.40	12.70	-	-	25.40	9.53	M6-17-494-BL	M611, M610	R6400	500	1
▲	B-494	<b>FNH</b>	25.40	12.70	-	-	25.40	9.53	M6-17-494-GN	M611, M610	R6400	500	1
▲	B-494	<b>FNH</b>	25.40	12.70	-	-	25.40	9.53	M6-17-494-OR	M611, M610	R6400	500	1
▲	B-494	<b>FNH</b>	25.40	12.70	-	-	25.40	9.53	M6-17-494-PK	M611, M610	R6400	500	1
▲	B-494	<b>FNH</b>	25.40	12.70	-	-	25.40	9.53	M6-17-494-RD	M611, M610	R6400	500	1
▲	B-494	<b>FNH</b>	25.40	12.70	-	-	25.40	9.53	M6-17-494-YL	M611, M610	R6400	500	1
▲	B-494	<b>FNH</b>	25.40	25.40	-	-	25.40	22.23	M6-19-494-BL	M611, M610	R6400	250	1
▲	B-494	<b>FNH</b>	25.40	25.40	-	-	25.40	22.23	M6-19-494-GN	M611, M610	R6400	250	1
▲	B-494	<b>FNH</b>	25.40	25.40	-	-	25.40	22.23	M6-19-494-OR	M611, M610	R6400	250	1
▲	B-494	<b>FNH</b>	25.40	25.40	-	-	25.40	22.23	M6-19-494-PK	M611, M610	R6400	250	1
▲	B-494	<b>FNH</b>	25.40	25.40	-	-	25.40	22.23	M6-19-494-RD	M611, M610	R6400	250	1
▲	B-494	<b>FNH</b>	25.40	25.40	-	-	25.40	22.23	M6-19-494-YL	M611, M610	R6400	250	1
▲	B-492	<b>FNHL</b>	25.40	44.45	-	-	-	-	M6-203-492	M610, M611	R4300, R6400	250	1
▲	B-499	<b>FNA</b>	25.40	76.20	-	-	-	-	M4-22-499	M410, M510, M511	R4300	100	1
▲	B-494	<b>FNH</b>	41.28	15.24	-	-	-	-	B33-302-494-BL	i3300, i5300	R6400	1500	1
▲	B-494	<b>FNH</b>	41.28	15.24	-	-	-	-	B33-302-494-GN	i3300, i5300	R6400	1500	1
▲	B-494	<b>FNH</b>	41.28	15.24	-	-	-	-	B33-302-494-OR	i3300, i5300	R6400	1500	1
▲	B-494	<b>FNH</b>	41.28	15.24	-	-	-	-	B33-302-494-PK	i3300, i5300	R6400	1500	1
▲	B-494	<b>FNH</b>	41.28	15.24	-	-	-	-	B33-302-494-RD	i3300, i5300	R6400	1500	1
▲	B-494	<b>FNH</b>	41.28	15.24	-	-	-	-	B33-302-494-YL	i3300, i5300	R6400	1500	1
▲	B-490	<b>FNHL</b>	45.72	15.24	-	-	-	-	M4-126-490	M511, BMP41, BMP51	R4300	180	-
▲	B-7425J	<b>FNAH</b>	48.26	25.40	-	-	-	-	J-156-7425J	J7300		1	1
▲	B-7425J	<b>FNAH</b>	50.80	25.40	-	-	-	-	J-137-7425J	J7300		1	1
<b>15.0 ml</b>													
▲	B-492	<b>FNHL</b>	25.40	48.26	-	-	-	-	M6-204-492	M610, M611	R4300, R6400	250	1
▷	B-461	<b>FNAHSL</b>	63.50	38.10	-	-	19.05	38.10	M6-157-461	M610, M611	R4300, R6200	100	1

**F** Freezer environment    **N** Liquid nitrogen environment    **A** Autoclave environment    **H** Hot water bath (100°C)    **S** Self-laminating label    **L** Low-profile (extremely thin) label    **R** Removable

# Cryo Tubes & Vials



## Cryo Tubes & Vials

Brady's offers a range of labels designed specifically to identify laboratory samples for cryo storage. These labels can be applied to room temperature or to already frozen samples, albeit with a small overlap. The label will remain legible and will stick to the sample container during processing, even when exposed to extreme heat or chemicals like DMSO, Xylene and Ethanol, ensuring secure sample identification in the most challenging laboratory conditions.

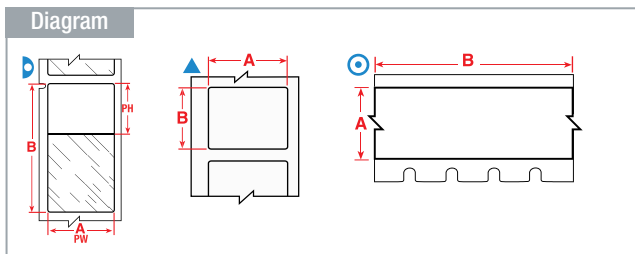

- F** Freezer environment
- N** Liquid nitrogen environment
- A** Autoclave environment
- H** Hot water bath (100°C)
- S** Self-laminating label
- L** Low-profile (extremely thin) label
- R** Removable

Labels are shown per vial / tube size and in order of label width.

The background colours in the Order Reference column represent the material colour.

See page 54 for Brady's range of label printers.

Diagram	Material	Special Properties	Label Width A (mm)	Label Height B (mm)	Label Length B (m)	Diameter C (mm)	Printable Area Width PW (mm)	Printable Area Height PH (mm)	Order Reference	Printer Compatibility	Printer Ribbon Series	Labels per Roll	Labels per Row
▶	B-461	<b>FNAHSL</b>	5.08	22.86	-	-	5.08	18.03	BPT-614-461	BBP12	R7950	2000	1
▶	B-461	<b>FNAHSL</b>	5.08	22.86	-	-	5.08	18.29	B33-614-461	i3300	B30-R4300	2000	1
▶	B-461	<b>FNAHSL</b>	6.35	27.94	-	-	6.35	22.09	B33-627-461	i3300	B30-R4300	1000	1
▶	B-461	<b>FNAHSL</b>	6.35	27.94	-	-	6.35	22.09	BPT-627-461	BBP12	R7950	1000	1
▶	B-461	<b>FNAHSL</b>	9.53	45.72	-	-	9.53	19.05	M7-73-461	M710	R6200	250	1
⊙	B-499	<b>FNA</b>	9.53	-	4.88	-	-	-	M21-375-499	M210-LAB, M211	R4300	1	-
⊙	B-499	<b>FNA</b>	9.53	-	4.88	-	-	-	M4C-375-499	M511, BMP41, BMP51	R4300	1	-
⊙	B-461	<b>FNAHSL</b>	9.53	-	6.40	-	-	-	M21-375-461-AW**	M210-LAB, M211	R4300	1	-
⊙	B-461	<b>FNAHSL</b>	9.53	-	7.62	-	-	-	M4C-375-461	M511, BMP41, BMP51	R4300	1	-
⊙	B-461	<b>FNAHSL</b>	9.53	-	15.24	-	-	-	M6C-375-461	M610, M611	R4300, R6200	1	1
▲	B-499	<b>FNA</b>	12.70	19.05	-	-	-	-	M7-11-499	M710	R4300, R6000HF, R6200	500	1
⊙	B-499	<b>FNA</b>	12.70	-	4.88	-	-	-	M21-500-499	M210-LAB, M211	R4300	1	-
⊙	B-499	<b>FNA</b>	12.70	-	4.88	-	-	-	M4C-500-499	M511, BMP41, BMP51	R4300	1	-
⊙	B-461	<b>FNAHSL</b>	12.70	-	6.40	-	-	-	M21-500-461-AW**	M210-LAB, M211	R4300	1	-
⊙	B-461	<b>FNAHSL</b>	12.70	-	7.62	-	-	-	M4C-500-461	M511, BMP41, BMP51	R4300	1	-
⊙	B-499	<b>FNA</b>	12.70	-	9.14	-	-	-	M7C-500-499	M710	R4300, R6000HF, R6200	1	1
⊙	B-461	<b>FNAHSL</b>	12.70	-	15.24	-	-	-	M6C-500-461	M610, M611	R4300, R6200	1	1
▲	B-499	<b>FNA</b>	19.05	12.70	-	-	-	-	BM-11-499	M610, M611, M710	R4300, R6000HF, R6200	5000	1
▲	B-499	<b>FNA</b>	19.05	12.70	-	-	-	-	M21-11-499	M210-LAB, M211	R4300	1	1
▲	B-499	<b>FNA</b>	19.05	12.70	-	-	-	-	M4-11-499	M511, BMP41, BMP51	R4300	220	-
▲	B-499	<b>FNA</b>	19.05	12.70	-	-	-	-	M6-11-499	M610, M611	R4300, R6200	500	1
▲	B-492	<b>FNHL</b>	20.96	9.53	-	-	-	-	M4-130-492	M511, BMP41, BMP51	R6400	220	-
▲	B-499	<b>FNA</b>	20.96	9.53	-	-	-	-	M4-130-499	M511, BMP41, BMP51	R4300	220	-
⊗	B-499	<b>FA</b>	22.86	12.70	-	12.70	-	-	M6-117-499	M610, M611	R4300, R6200	500	1
▲	B-499	<b>FNA</b>	22.86	12.70	-	-	-	-	M5-84-499	M511, BMP51	R4300	200	-

\*\*AW = All White / no transparent area.



# Cryo Tubes & Vials

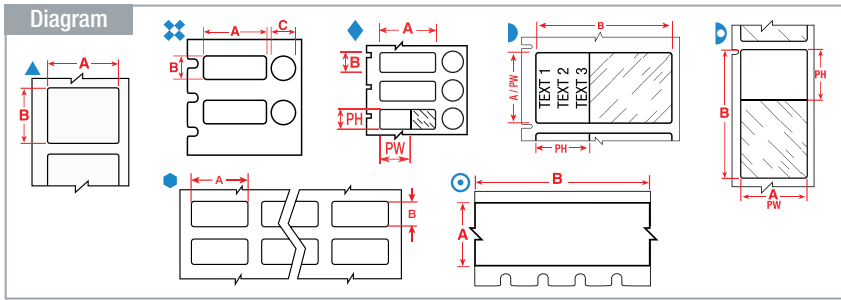

The background colours in the Order Reference column represent the material colour.

See page 54 for Brady's range of label printers.

Labels are shown per vial / tube size and in order of label width.

Diagram	Material	Special Properties	Label Width A (mm)	Label Height B (mm)	Label Length B (m)	Diameter C (mm)	Printable Area Width PW (mm)	Printable Area Height PH (mm)	Order Reference	Printer Compatibility	Printer Ribbon Series	Labels per Roll	Labels per Row
<b>0.5 ml</b>													
◆	B-461	<b>F AHSL</b>	25.40	9.53	-	9.53	20.00	9.53	BPT-606-461	BBP12	R7950	1000	1
◆	B-461	<b>F AHSL</b>	25.40	9.53	-	9.53	25.40	9.53	B33-606-461	i3300	B30-R4300	1000	1
⊕	B-499	<b>F A</b>	25.40	9.53	-	9.53	-	-	M6-98-499	M610, M611	R4300, R6200	500	1
▲	B-7425J	<b>FNAH</b>	25.40	9.53	-	-	-	-	J-152-7425J	J7300		1	2
⊕	B-7425J	<b>FNAH</b>	25.40	9.53	-	-	-	-	J-249-7425J	J7300		1	1
●	B-499	<b>FNA</b>	25.40	12.70	-	-	-	-	B33-5-499	i3300, i5300	B30 Monocolour	5000	3
⊕	B-7425J	<b>FNAH</b>	25.40	12.70	-	-	-	-	J-251-7425J	J7300		1	1
▲	B-7425J	<b>FNAH</b>	25.40	12.70	-	-	-	-	J-59-7425J	J7300		1	1
▲	B-492	<b>FN H L</b>	25.40	12.70	-	-	-	-	M4-131-492	M511, BMP41, BMP51	R6400	180	-
▲	B-499	<b>FNA</b>	25.40	12.70	-	-	-	-	M4-131-499	M511, BMP41, BMP51	R4300	180	-
▷	B-461	<b>FNAHSL</b>	28.58	12.70	-	-	19.05	12.70	M5-122-461	M511, BMP51	R4300	360	-
▷	B-461	<b>FNAHSL</b>	28.58	12.70	-	-	19.05	12.70	M6-122-461	M610, M611	R4300, R6200	500	1
▷	B-461	<b>FNAHSL</b>	38.10	4.75	-	-	17.78	4.75	M6-108-461	M610, M611	R4300, R6200	750	1
▷	B-461	<b>FNAHSL</b>	41.91	12.70	-	-	19.05	12.70	M4-124-461	M511, BMP41, BMP51	R4300	180	-
▷	B-461	<b>FNAHSL</b>	41.91	12.70	-	-	19.05	12.70	M6-202-461	M610, M611	R4300, R6200	500	1
▷	B-461	<b>FNAHSL</b>	44.45	12.70	-	-	19.05	12.70	M4-72-461	M511, BMP41, BMP51	R4300	180	-
▷	B-461	<b>FNAHSL</b>	45.72	12.70	-	-	19.05	12.70	B33-122-461	i3300	B30 Monocolour	1500	1
▷	B-461	<b>FNAHSL</b>	45.72	12.70	-	-	19.05	12.70	M6-72-461	M610, M611	R4300, R6200	500	1
▷	B-461	<b>FNAHSL</b>	45.72	12.70	-	-	19.05	12.70	THT-122-461-1.5-SC	BBP12	R7950	1500	1
▷	B-461	<b>FNAHSL</b>	45.72	12.70	-	-	19.05	12.70	THT-122-461-3	BBP12, i7100, i5100	R4300, R7950	3000	1
▷	B-461	<b>FNAHSL</b>	55.88	12.70	-	-	19.05	12.70	B33-127-461	i3300	B30 Monocolour	1500	3
▷	B-461	<b>FNAHSL</b>	55.88	12.70	-	-	19.05	12.70	M4-74-461	M511, BMP41, BMP51	R4300	140	-
▷	B-461	<b>FNAHSL</b>	55.88	12.70	-	-	19.05	12.70	M6-74-461	M610, M611	R4300, R6200	100	1
▷	B-461	<b>FNAHSL</b>	55.88	12.70	-	-	19.05	12.70	THT-127-461-1.5-SC	BBP12	R7950	1500	1
▷	B-461	<b>FNAHSL</b>	55.88	12.70	-	-	19.05	12.70	THT-127-461-3	BBP12, i7100, i5100	R4300, R7950	3000	1
<b>1.5 ml</b>													
▷	B-461	<b>FNAHSL</b>	15.24	41.28	-	-	15.24	25.40	M7-76-461	M710	R6200	500	1
●	B-499	<b>FNA</b>	19.05	23.80	-	-	-	-	B33-91-499	i3300, i5300	B30 Monocolour	2500	4
⊙	B-499	<b>FNA</b>	19.05	-	4.88	-	-	-	M21-750-499	M210-LAB, M211	R4300	1	-
⊙	B-499	<b>FNA</b>	19.05	-	4.88	-	-	-	M4C-750-499	M511, BMP41, BMP51	R4300	1	-
⊙	B-461	<b>FNAHSL</b>	19.05	-	6.40	-	-	-	M21-750-461-AW**	M210-LAB, M211	R4300	1	-
●	B-499	<b>FNA</b>	25.40	19.05	-	-	-	-	B33-88-499	i3300, i5300	B30 Monocolour	2500	2
●	B-7425J	<b>FNAH</b>	25.40	19.05	-	-	-	-	J-88-7425J	J7300		1	2
▲	B-499	<b>FNA</b>	25.40	19.05	-	-	-	-	M21-18-499	M210-LAB, M211	R4300	1	1
▷	B-461	<b>FNAHSL</b>	25.40	25.40	-	-	25.40	9.53	M7-19-461	M710	R4300	250	1
▷	B-461	<b>FNAHSL</b>	28.58	9.53	-	-	19.05	9.53	M5-123-461	M511, BMP51	R4300	360	-
▷	B-461	<b>FNAHSL</b>	28.58	9.53	-	-	19.05	9.53	M6-123-461	M610, M611	R4300, R6200	500	1
▲	B-490	<b>FN H L</b>	31.75	9.53	-	-	-	-	M5-112-490	M511, BMP51	R4300	360	-
▷	B-461	<b>FNAHSL</b>	41.28	15.24	-	-	25.40	15.24	M6-76-461	M610, M611	R4300, R6200	250	1
▷	B-461	<b>FNAHSL</b>	45.72	9.53	-	-	19.05	9.53	B33-123-461	i3300	B30 Monocolour	1500	1
▷	B-461	<b>FNAHSL</b>	45.72	9.53	-	-	19.05	9.53	M6-73-461	M610, M611	R4300, R6200	500	1
▷	B-461	<b>FNAHSL</b>	45.72	9.53	-	-	19.05	9.53	THT-123-461-1.5-SC	BBP12	R7950	1500	1
▷	B-461	<b>FNAHSL</b>	45.72	9.53	-	-	19.05	9.53	THT-123-461-3	BBP12, i7100, i5100	R4300, R7950	3000	1

\*\*AW = All White / no transparent area.

>>

<b>F</b> Freezer environment	<b>N</b> Liquid nitrogen environment	<b>A</b> Autoclave environment	<b>H</b> Hot water bath (100°C)	<b>S</b> Self-laminating label	<b>L</b> Low-profile (extremely thin) label	<b>R</b> Removable
------------------------------	--------------------------------------	--------------------------------	---------------------------------	--------------------------------	---	--------------------

# Cryo Tubes & Vials

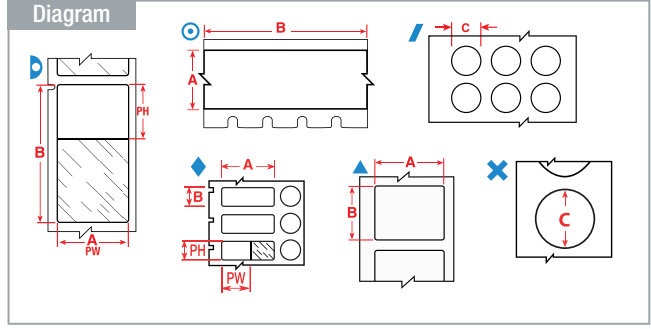
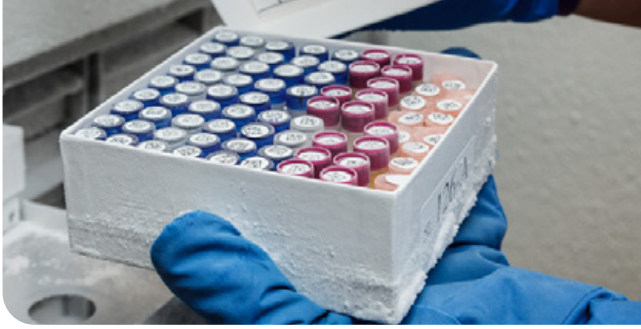

The background colours in the Order Reference column represent the material colour.

See page 54 for Brady's range of label printers.

Labels are shown per vial / tube size and in order of label width.

Diagram	Material	Special Properties	Label Width A (mm)	Label Height B (mm)	Label Length B (m)	Diameter C (mm)	Printable Area Width PW (mm)	Printable Area Height PH (mm)	Order Reference	Printer Compatibility	Printer Ribbon Series	Labels per Roll	Labels per Row
<b>1.5 ml</b>													
D	B-461	<b>FNAHSL</b>	45.72	15.24	-	-	25.40	15.24	M4-126-461	M511, BMP41, BMP51	R4300	180	-
D	B-461	<b>FNAHSL</b>	45.72	15.24	-	-	25.40	15.24	M6-201-461	M610, M611	R4300, R6200	100	1
D	B-461	<b>FNAHSL</b>	66.68	15.24	-	-	25.40	15.24	B33-153-461	i3300	B30 Monocolour	1500	1
D	B-461	<b>FNAHSL</b>	66.68	15.24	-	-	25.40	15.24	M4-86-461	M511, BMP41, BMP51	R4300	120	-
D	B-461	<b>FNAHSL</b>	66.68	15.24	-	-	25.40	15.24	THT-153-461-1.5-SC	BBP12	R7950	1500	1
D	B-461	<b>FNAHSL</b>	66.68	15.24	-	-	25.40	15.24	THT-153-461-3	BBP12, i7100, i5100	R4300, R7950	3000	1
D	B-461	<b>FNAHSL</b>	95.25	19.05	-	-	25.40	25.40	M6-79-461	M610, M611	R4300, R6200	100	1
/	B-461	<b>F A H L</b>	-	-	-	9.53	-	-	B33-602-461AW**	i3300	B30-R4300	3000	3
X	B-461	<b>F A H L</b>	-	-	-	9.53	-	-	BPT-602-461AW**	BBP12	R7950	3000	3
X	B-492	<b>F H L</b>	-	-	-	9.53	-	-	M4-82-492	M511, BMP41, BMP51	R6400	240	-
X	B-499	<b>F A</b>	-	-	-	9.53	-	-	M4-82-499	M511, BMP41, BMP51	R4300	240	-
X	B-499	<b>F A</b>	-	-	-	9.53	-	-	M4-82-499-OR-BK	M511, BMP41, BMP51	R4300	240	-
X	B-499	<b>F A</b>	-	-	-	9.53	-	-	M4-82-499-RD-BK	M511, BMP41, BMP51	R4300	240	-
X	B-499	<b>F A</b>	-	-	-	9.53	-	-	M4-82-499-YL-BK	M511, BMP41, BMP51	R4300	240	-
<b>2.0 ml</b>													
D	B-461	<b>FNAHSL</b>	15.00	40.00	-	-	15.00	29.97	BPTLAB-21-461-2.5	BBP12	R7950	2500	1
D	B-461	<b>FNAHSL</b>	15.24	38.10	-	-	15.24	33.00	M7-100-461	M710	R6200	500	1
D	B-461	<b>FNAHSL</b>	15.24	38.10	-	-	15.24	33.02	B33-628-461	i3300	B30-R4300	2500	2
D	B-461	<b>FNAHSL</b>	15.24	38.10	-	-	15.24	33.02	BPT-628-461	BBP12	R7950	2500	2
D	B-461	<b>FNAHSL</b>	15.24	66.68	-	-	15.24	25.40	B33-612-461	i3300	B30-R4300	1500	3
D	B-461	<b>FNAHSL</b>	15.24	66.68	-	-	15.24	25.40	BPT-612-461	BBP12	R7950	1500	3
D	B-461	<b>FNAHSL</b>	19.05	38.10	-	-	19.05	33.02	B33-629-461	i3300	B30-R4300	2500	2
▲	B-492	<b>FN H L</b>	22.86	25.40	-	-	-	-	M5-156-492	M511, BMP51	R6400	180	-
▲	B-7425J	<b>FNAH</b>	25.40	25.40	-	-	-	-	J-179-7425J	J7300		1	1
D	B-461	<b>FNAHSL</b>	25.40	44.45	-	-	25.40	25.40	M7-106-461	M710	R6200	250	1
D	B-461	<b>FNAHSL</b>	25.40	66.68	-	-	25.40	25.40	M7-115-461	M710	R6200	100	1
⊙	B-499	<b>FNA</b>	25.40	-	4.88	-	-	-	M5C-1000-499	M511, BMP51	R4300	1	-
⊙	B-7425	<b>FNAH</b>	25.40	-	7.62	-	-	-	M4C-1000-7425	M410, M510, M511	R4300	1	-
⊙	B-461	<b>FNAHSL</b>	25.40	-	7.62	-	-	-	M5C-1000-461	M511, BMP51	R4300	1	-
⊙	B-499	<b>FNA</b>	25.40	-	9.14	-	-	-	M7C-1000-499	M710	R4300, R6000HF, R6200	1	1
▲	B-7425J	<b>FNAH</b>	33.02	15.24	-	-	-	-	J-256-7425J	J7300		1	1
◆	B-461	<b>F AHSL</b>	40.00	15.00	-	9.53	29.97	15.00	M7-101-461	M710	R6200	250	1
D	B-461	<b>FNAHSL</b>	44.45	25.40	-	-	25.40	25.40	B33-183-461	i3300	B30 Monocolour	2000	1
D	B-461	<b>FNAHSL</b>	44.45	25.40	-	-	25.40	25.40	M6-203-461	M610, M611	R4300, R6200	100	1
D	B-461	<b>FNAHSL</b>	44.45	25.40	-	-	25.40	25.40	THT-183-461-1	BBP12, i7100, i5100	R4300, R7950	1000	1
X	B-499	<b>F A</b>	-	-	-	12.70	-	-	M4-83-499	M511, BMP41, BMP51	R4300	240	-
X	B-499	<b>F A</b>	-	-	-	12.70	-	-	M4-83-499-OR-BK	M511, BMP41, BMP51	R4300	240	-
X	B-499	<b>F A</b>	-	-	-	12.70	-	-	M4-83-499-RD-BK	M511, BMP41, BMP51	R4300	240	-
X	B-499	<b>F A</b>	-	-	-	12.70	-	-	M4-83-499-YL-BK	M511, BMP41, BMP51	R4300	240	-

\*\*AW = All White / no transparent area.

>>

<b>F</b> Freezer environment	<b>N</b> Liquid nitrogen environment	<b>A</b> Autoclave environment	<b>H</b> Hot water bath (100°C)	<b>S</b> Self-laminating label	<b>L</b> Low-profile (extremely thin) label	<b>R</b> Removable
------------------------------	--------------------------------------	--------------------------------	---------------------------------	--------------------------------	---	--------------------

# Cryo Tubes & Vials

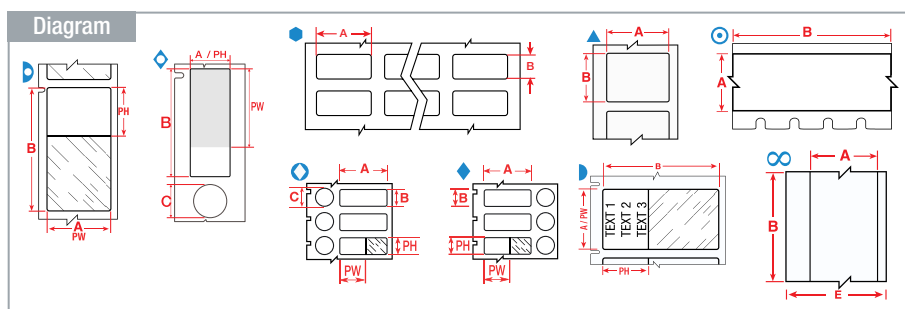

The background colours in the Order Reference column represent the material colour.

See page 54 for Brady's range of label printers.

Labels are shown per vial / tube size and in order of label width.

Diagram	Material	Special Properties	Label Width A (mm)	Label Height B (mm)	Label Length B (m)	Diameter C (mm)	Printable Area Width PW (mm)	Printable Area Height PH (mm)	Order Reference	Printer Compatibility	Printer Ribbon Series	Labels per Roll	Labels per Row
<b>4.0 ml</b>													
●	B-499	<b>FNA</b>	12.70	36.50	-	-	-	-	B33-87-499	i3300, i5300	B30 Monocolour	2500	6
●	B-7425J	<b>FNAH</b>	12.70	38.10	-	-	-	-	J-37-7425J	J7300		1	2
▲	B-499	<b>FNA</b>	12.70	38.10	-	-	-	-	M7-29-499	M710	R4300, R6000HF, R6200	500	1
◇	B-461	<b>F AHSLS</b>	15.24	41.28	-	12.70	15.24	30.00	M7-116-461	M710	R6200	150	1
▷	B-461	<b>FNAHSLS</b>	15.24	48.26	-	-	15.24	39.88	B33-638-461	i3300	B30-R4300	2000	1
▷	B-461	<b>FNAHSLS</b>	15.24	48.26	-	-	15.24	39.88	BPT-638-461	BBP12	R7950	2000	1
▷	B-461	<b>FNAHSLS</b>	15.24	48.26	-	-	15.24	40.00	M7-119-461	M710	R6200	500	1
▷	B-461	<b>FNAHSLS</b>	25.40	38.10	-	-	25.40	12.70	M7-31-461	M710	R4300, R7950	250	1
▲	B-492	<b>FNHL</b>	25.40	48.26	-	-	-	-	M5-78-492	M511, BMP51	R6400	100	-
∞	B-7425J	<b>FNAH</b>	28.58	-	45.72	-	-	-	JC-1125-7425J	J7300		1	1
◎	B-461	<b>FNAHSLS</b>	31.75	-	7.62	-	-	-	M5C-1250-461	M511, BMP51	R4300	1	-
▷	B-461	<b>FNAHSLS</b>	34.93	45.72	-	-	34.93	39.88	B33-632-461	i3300	B30-R4300	1500	1
▷	B-461	<b>FNAHSLS</b>	34.93	45.72	-	-	34.93	39.88	BPT-632-461	BBP12	R7950	2000	1
▷	B-461	<b>FNAHSLS</b>	38.10	19.05	-	-	38.10	19.05	BPT-629-461	BBP12	R7950	2500	2
▲	B-7425J	<b>FNAH</b>	38.10	19.05	-	-	-	-	J-136-7425J	J7300		1	1
▲	B-7425J	<b>FNAH</b>	38.10	25.40	-	-	-	-	J-235-7425J	J7300		1	1
▲	B-499	<b>FNA</b>	38.10	31.75	-	-	-	-	M5-132-499	M511, BMP51	R4300	160	-
▲	B-7425J	<b>FNAH</b>	38.10	44.45	-	-	-	-	J-258-7425J	J7300		1	1
◎	B-7425	<b>FNAH</b>	38.10	-	7.62	-	-	-	M5C-1500-7425	M510, M511	R4300	1	-
◆	B-461	<b>F AHSLS</b>	40.00	15.00	-	9.00	40.00	15.00	BPTLAB-20-461-2.5	BBP12	R7950	2500	1
◇	B-461	<b>F AHSLS</b>	41.28	15.24	-	12.70	41.28	15.24	B33-608-461	i3300	B30-R4300	1000	1
◆	B-461	<b>F AHSLS</b>	41.28	15.24	-	12.70	41.28	15.24	BPT-608-461	BBP12	R7950	1000	1
▷	B-461	<b>FNAHSLS</b>	41.28	15.24	-	-	25.40	15.24	B33-133-461	i3300	B30 Monocolour	1500	3
▷	B-461	<b>FNAHSLS</b>	41.28	15.24	-	-	25.40	15.24	THT-133-461-1.5-SC	BBP12	R7950	1500	1
▷	B-461	<b>FNAHSLS</b>	41.28	15.24	-	-	25.40	15.24	THT-133-461-3	BBP12, i7100, i5100	R4300, R7950	3000	1
▲	B-490	<b>FNHL</b>	41.28	15.24	-	-	-	-	M6-76-490	M610, M611	R4300	250	1
▷	B-461	<b>FNAHSLS</b>	44.45	25.40	-	-	25.40	25.40	M5-125-461	M511, BMP51	R4300	180	-
▷	B-461	<b>FNAHSLS</b>	66.68	25.40	-	-	25.40	25.40	B33-276-461	i3300	B30 Monocolour	1500	2
▷	B-461	<b>FNAHSLS</b>	66.68	25.40	-	-	25.40	25.40	BM-75-461	M610, M611, M710	R4300, R6200	1000	1
▷	B-461	<b>FNAHSLS</b>	66.68	25.40	-	-	25.40	25.40	M5-75-461	M511, BMP51	R4300	120	-
▷	B-461	<b>FNAHSLS</b>	66.68	25.40	-	-	25.40	25.40	M6-75-461	M610, M611	R4300, R6200	100	1
▷	B-461	<b>FNAHSLS</b>	66.68	25.40	-	-	25.40	25.40	M6-75-461-YL	M610, M611	R4300, R6200	100	1
▷	B-461	<b>FNAHSLS</b>	66.68	25.40	-	-	25.40	25.40	THT-131-461-1.5-SC	BBP12	R7950	1500	1
▷	B-461	<b>FNAHSLS</b>	66.68	25.40	-	-	25.40	25.40	THT-131-461-3	BBP12, i7100, i5100	R4300, R7950	3000	1
▷	B-461	<b>FNAHSLS</b>	88.90	38.10	-	-	31.75	38.10	B33-134-461	i3300	B30 Monocolour	1000	1
▷	B-461	<b>FNAHSLS</b>	88.90	38.10	-	-	31.75	38.10	THT-134-461-3	BBP12, i7100, i5100	R4300, R7950	3000	1

>>



**F** Freezer environment    **N** Liquid nitrogen environment    **A** Autoclave environment    **H** Hot water bath (100°C)    **S** Self-laminating label    **L** Low-profile (extremely thin) label    **R** Removable

# Cryo Tubes & Vials

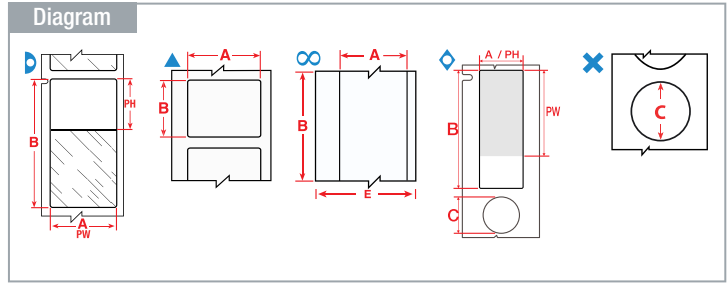
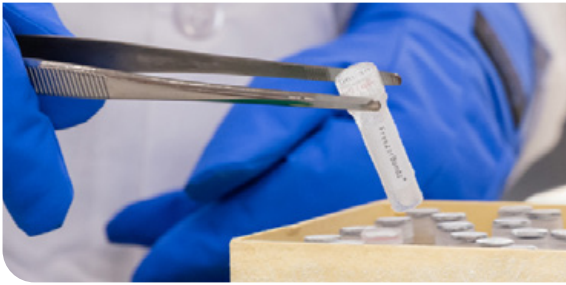

The background colours in the Order Reference column represent the material colour.

See page 54 for Brady's range of label printers.

Labels are shown per vial / tube size and in order of label width.

Diagram	Material	Special Properties	Label Width A (mm)	Label Height B (mm)	Label Length B (m)	Diameter C (mm)	Printable Area Width PW (mm)	Printable Area Height PH (mm)	Order Reference	Printer Compatibility	Printer Ribbon Series	Labels per Roll	Labels per Row
<b>8.0 ml</b>													
▶	B-461	<b>FNAHSL</b>	15.24	66.68	-	-	15.24	25.40	M7-86-461	M710	R6200	100	1
▶	B-461	<b>FNAHSL</b>	15.24	66.68	-	-	25.40	15.24	M6-86-461	M610, M611	R4300, R6200	100	1
◇	B-494	<b>FN H</b>	25.40	9.53	-	9.53	25.40	6.35	M6-98-494-BL	M611, M610	R6400	500	1
◇	B-494	<b>FN H</b>	25.40	9.53	-	9.53	25.40	6.35	M6-98-494-GN	M611, M610	R6400	500	1
◇	B-494	<b>FN H</b>	25.40	9.53	-	9.53	25.40	6.35	M6-98-494-OR	M611, M610	R6400	500	1
◇	B-494	<b>FN H</b>	25.40	9.53	-	9.53	25.40	6.35	M6-98-494-PK	M611, M610	R6400	500	1
◇	B-494	<b>FN H</b>	25.40	9.53	-	9.53	25.40	6.35	M6-98-494-RD	M611, M610	R6400	500	1
◇	B-494	<b>FN H</b>	25.40	9.53	-	9.53	25.40	6.35	M6-98-494-YL	M611, M610	R6400	500	1
▲	B-494	<b>FN H</b>	25.40	12.70	-	-	25.40	9.53	M6-17-494-BL	M611, M610	R6400	500	1
▲	B-494	<b>FN H</b>	25.40	12.70	-	-	25.40	9.53	M6-17-494-GN	M611, M610	R6400	500	1
▲	B-494	<b>FN H</b>	25.40	12.70	-	-	25.40	9.53	M6-17-494-OR	M611, M610	R6400	500	1
▲	B-494	<b>FN H</b>	25.40	12.70	-	-	25.40	9.53	M6-17-494-PK	M611, M610	R6400	500	1
▲	B-494	<b>FN H</b>	25.40	12.70	-	-	25.40	9.53	M6-17-494-RD	M611, M610	R6400	500	1
▲	B-494	<b>FN H</b>	25.40	12.70	-	-	25.40	9.53	M6-17-494-YL	M611, M610	R6400	500	1
▲	B-494	<b>FN H</b>	25.40	25.40	-	-	25.40	22.23	M6-19-494-BL	M611, M610	R6400	250	1
▲	B-494	<b>FN H</b>	25.40	25.40	-	-	25.40	22.23	M6-19-494-GN	M611, M610	R6400	250	1
▲	B-494	<b>FN H</b>	25.40	25.40	-	-	25.40	22.23	M6-19-494-OR	M611, M610	R6400	250	1
▲	B-494	<b>FN H</b>	25.40	25.40	-	-	25.40	22.23	M6-19-494-PK	M611, M610	R6400	250	1
▲	B-494	<b>FN H</b>	25.40	25.40	-	-	25.40	22.23	M6-19-494-RD	M611, M610	R6400	250	1
▲	B-494	<b>FN H</b>	25.40	25.40	-	-	25.40	22.23	M6-19-494-YL	M611, M610	R6400	250	1
▲	B-499	<b>FNA</b>	25.40	76.20	-	-	-	-	M4-22-499	M410, M510, M511	R4300	100	1
▲	B-490	<b>FN H L</b>	45.72	15.24	-	-	-	-	M4-126-490	M511, BMP41, BMP51	R4300	180	-
▲	B-461	<b>FNAH L</b>	48.26	25.40	-	-	48.26	-	B33-636-461AW**	i3300	B30-R4300	2000	1
▲	B-461	<b>FNAH L</b>	48.26	25.40	-	-	48.26	-	BPT-636-461-AW**	BBP12	R7950	2000	1
▲	B-7425J	<b>FNAH</b>	48.26	25.40	-	-	-	-	J-156-7425J	J7300		1	1
▲	B-490	<b>FN H L</b>	48.26	25.40	-	-	-	-	M6-78-490	M610, M611	R4300	250	1
▲	B-7425J	<b>FNAH</b>	50.80	25.40	-	-	-	-	J-137-7425J	J7300		1	1
<b>15.0 ml</b>													
▶	B-461	<b>FNAHSL</b>	57.15	38.10	-	-	31.75	38.10	M5-129-461	M511, BMP51	R4300	140	-
▶	B-461	<b>FNAHSL</b>	63.50	38.10	-	-	19.05	38.10	M6-157-461	M610, M611	R4300, R6200	100	1
▲	B-7425J	<b>FNAH</b>	76.20	25.40	-	-	-	-	J-18-7425J	J7300		1	1
▶	B-461	<b>FNAHSL</b>	95.25	38.10	-	-	31.75	38.10	M5-119-461	M511, BMP51	R4300	80	-
▶	B-461	<b>FNAHSL</b>	133.35	25.40	-	-	38.10	25.40	B33-139-461	i3300	B30 Monocolour	650	2
▶	B-461	<b>FNAHSL</b>	133.35	25.40	-	-	38.10	25.40	THT-139-461-2	BBP12, i7100, i5100	R4300, R7950	2000	2
✕	B-461	<b>F A H L</b>	-	-	-	15.24	-	-	BPT-604-461AW**	BBP12	R7950	3000	3
<b>25.0 ml</b>													
▲	B-461	<b>FNAH L</b>	57.15	19.05	-	-	57.15	-	B33-642-461AW**	i3300	B30-R4300	2000	1
▲	B-461	<b>FNAH L</b>	57.15	19.05	-	-	57.15	-	BPT-642-461-AW**	BBP12	R7950	2000	1
∞	B-7425J	<b>FNAH</b>	57.15	-	45.72	-	-	-	JC-2250-7425J	J7300		1	1
▶	B-461	<b>FNAHSL</b>	88.90	38.10	-	-	25.40	15.24	M6-77-461	M610, M611	R4300, R6200	100	1
▲	B-461	<b>FNAH L</b>	88.90	38.10	-	-	88.90	-	B33-650-461AW**	i3300	B30-R4300	2000	1
▲	B-461	<b>FNAH L</b>	88.90	38.10	-	-	88.90	-	BPT-650-461-AW**	BBP12	R7950	2000	1

\*\*AW = All White / no transparent area.

<b>F</b> Freezer environment	<b>N</b> Liquid nitrogen environment	<b>A</b> Autoclave environment	<b>H</b> Hot water bath (100°C)	<b>S</b> Self-laminating label	<b>L</b> Low-profile (extremely thin) label	<b>R</b> Removable
------------------------------	--------------------------------------	--------------------------------	---------------------------------	--------------------------------	---	--------------------

# Conical / Large Tube Labels



- F** Freezer environment
- N** Liquid nitrogen environment
- A** Autoclave environment
- H** Hot water bath (100°C)
- S** Self-laminating label
- L** Low-profile (extremely thin) label
- R** Removable

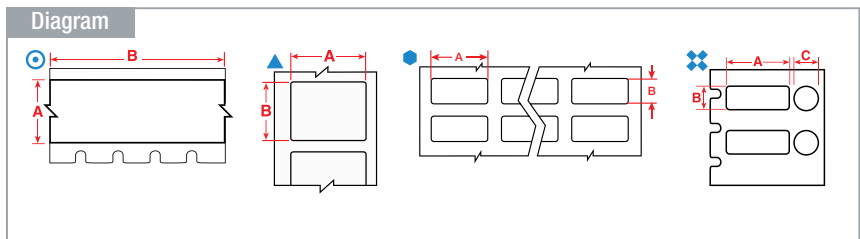

## Conical / Large Tube Labels

Brady offers several sample identification labels which are perfect to identify conicals. They are easy to handle, have great flexibility and easily wrap around curved sample containers. Your sample identification label will remain attached and legible, even when the sample is stored in a freezer, in liquid nitrogen or heated in an autoclave.

The background colours in the Order Reference column represent the material colour.

See page 54 for Brady's range of label printers.

Labels are shown per vial / tube size and in order of label width.

Diagram	Material	Special Properties	Label Width A (mm)	Label Height B (mm)	Label Length B (m)	Diameter C (mm)	Printable Area Width PW (mm)	Printable Area Height PH (mm)	Order Reference	Printer Compatibility	Printer Ribbon Series	Labels per Roll	Labels per Row
<b>0.5 ml</b>													
⊙	B-423	<b>F AH</b>	6.35	-	6.40	-	-	-	M21-250-423	M210-LAB, M211	R6200	1	-
⊙	B-499	<b>F NA</b>	9.53	-	4.88	-	-	-	M21-375-499	M210-LAB, M211	R4300	1	-
⊙	B-499	<b>F NA</b>	9.53	-	4.88	-	-	-	M4C-375-499	M511, BMP41, BMP51	R4300	1	-
⊙	B-461	<b>F NAHSL</b>	9.53	-	6.40	-	-	-	M21-375-461-AW**	M210-LAB, M211	R4300	1	-
▲	B-423	<b>F AH</b>	12.70	12.70	-	-	-	-	BM-7-423	M610, M611, M710	R6000HF, R6200	5000	1
▲	B-423	<b>F A</b>	12.70	12.70	-	-	-	-	M6-7-423	M610, M611	R6000HF, R6200, R4400	500	1
▲	B-423	<b>F AH</b>	12.70	12.70	-	-	-	-	M7-7-423	M710	R6000HF	500	1
●	B-499	<b>F NA</b>	12.70	19.05	-	-	-	-	B33-68-499	i3300	B30 Monocolour	1500	4
▲	B-499	<b>F NA</b>	12.70	19.05	-	-	-	-	M7-11-499	M710	R4300, R6000HF, R6200	500	1
●	B-499	<b>F NA</b>	12.70	19.05	-	-	-	-	THT-68-499-10	BBP12, i7100, i5100	R4900	10000	4
▲	B-499	<b>F NA</b>	12.70	25.40	-	-	-	-	B33-620-499	i3300	B30-R6000	1000	1
▲	B-499	<b>F NA</b>	12.70	25.40	-	-	-	-	BPT-620-499	BBP12	R7950	1000	1
⊙	B-499	<b>F NA</b>	12.70	-	4.88	-	-	-	M21-500-499	M210-LAB, M211	R4300	1	-
⊙	B-499	<b>F NA</b>	12.70	-	4.88	-	-	-	M4C-500-499	M511, BMP41, BMP51	R4300	1	-
⊙	B-461	<b>F NAHSL</b>	12.70	-	6.40	-	-	-	M21-500-461-AW**	M210-LAB, M211	R4300	1	-
⊙	B-499	<b>F NA</b>	12.70	-	9.14	-	-	-	M7C-500-499	M710	R4300, R6000HF, R6200	1	1
▲	B-499	<b>F NA</b>	19.05	12.70	-	-	-	-	M21-11-499	M210-LAB, M211	R4300	1	1
▲	B-423	<b>F AH</b>	19.05	12.70	-	-	-	-	M21-7-423	M210-LAB, M211	R6000HF	1	1
⊘	B-499	<b>F A</b>	22.86	12.70	-	12.70	-	-	B33-126-499	i3300	B30 Monocolour	1500	1
⊘	B-499	<b>F A</b>	22.86	12.70	-	12.70	-	-	M7-126-499	M710	R4300	500	1
⊘	B-499	<b>F A</b>	22.86	12.70	-	12.70	-	-	THT-126-499-3	i7100, i5100	R4900	3000	1
▲	B-499	<b>F NA</b>	22.86	12.70	-	-	-	-	B33-125-499	i3300	B30 Monocolour	1500	1
▲	B-499	<b>F NA</b>	22.86	12.70	-	-	-	-	M6-84-499	M610, M611	R4300, R6200	500	1
▲	B-499	<b>F NA</b>	22.86	12.70	-	-	-	-	M7-84-499	M710	R4300, R6000HF, R6200	500	1
▲	B-499	<b>F NA</b>	22.86	12.70	-	-	-	-	THT-125-499-1.5-SC	BBP12	R7950, R4300, R4900	1500	1
▲	B-499	<b>F NA</b>	22.86	12.70	-	-	-	-	THT-125-499-3	BBP12, i7100, i5100	R4900	3000	1

\*\*AW = All White / no transparent area.

>>

# Conical / Large Tube Labels

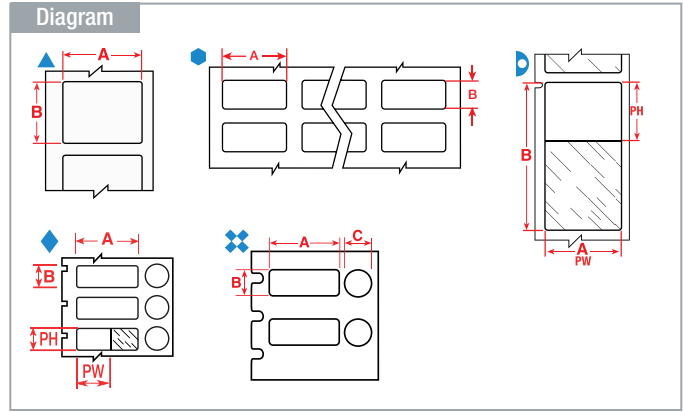

Labels are shown per vial / tube size and in order of label width.

The background colours in the Order Reference column represent the material colour.

See page 54 for Brady's range of label printers.

Diagram	Material	Special Properties	Label Width A (mm)	Label Height B (mm)	Label Length B (m)	Diameter C (mm)	Printable Area Width (mm)	Printable Area Height (mm)	Order Reference	Printer Compatibility	Printer Ribbon Series	Labels per Roll	Labels per Row
<b>0.5 ml</b>													
◆	B-461	F AHSL	25.40	9.53	-	9.53	20.00	9.53	BPT-606-461	BBP12	R7950	1000	1
◆	B-461	F AHSL	25.40	9.53	-	9.53	25.40	9.53	B33-606-461	i3300	B30-R4300	1000	1
⊠	B-499	F A	25.40	9.53	-	9.53	25.40	9.53	THT-249-499-1.5-SC	BBP12	R7950, R4300, R4900	1500	1
⊠	B-499	F A	25.40	9.53	-	9.53	-	-	M7-98-499	M710	R4300, R6000HF, R6200	500	1
⊠	B-492	F H L	25.40	9.53	-	9.53	-	-	THT-163-492-3	BBP12, i7100, i5100	R6400	3000	1
⊠	B-499	F A	25.40	9.53	-	9.53	-	-	THT-163-499-3	i7100, i5100	R4900	3000	1
⊠	B-492	F H L	25.40	9.53	-	9.53	-	-	THT-249-492-1.5-SC	BBP12	R6400	1500	1
⊠	B-492	F N H L	25.40	9.53	-	-	-	-	B33-152-492	i3300	B30 Monocolour	2500	2
⊠	B-499	F N A	25.40	9.53	-	-	-	-	B33-152-499	i3300	B30 Monocolour	1500	2
▲	B-7425J	F N A H	25.40	9.53	-	-	-	-	J-152-7425J	J7300		1	2
⊕	B-7425J	F N A H	25.40	9.53	-	-	-	-	J-249-7425J	J7300		1	1
▲	B-492	F N H L	25.40	9.53	-	-	-	-	M7-16-492	M710	R6400	500	1
⊠	B-492	F N H L	25.40	9.53	-	-	-	-	THT-152-492-2.5-SC	BBP12	R6400	2500	2
⊠	B-492	F N H L	25.40	9.53	-	-	-	-	THT-152-492-3	BBP12, i7100, i5100	R6400	3000	2
⊠	B-499	F N A	25.40	9.53	-	-	-	-	THT-152-499-1.5-SC	BBP12	R7950, R4300, R4900	1500	2
⊠	B-499	F N A	25.40	9.53	-	-	-	-	THT-152-499-3	BBP12, i7100, i5100	R4900	3000	2
⊠	B-492	F H L	25.40	12.70	-	9.53	-	-	M7-118-492	M710	R6400	500	1
⊠	B-492	F H L	25.40	12.70	-	9.53	-	-	THT-181-492-3	i7100, i5100	R6400	3000	1
⊠	B-492	F H L	25.40	12.70	-	9.53	-	-	THT-250-492-1.5-SC	BBP12	R6400	1500	1
⊠	B-492	F H L	25.40	12.70	-	11.18	-	-	THT-182-492-3	BBP12, i7100, i5100	R6400	3000	1
⊠	B-492	F H L	25.40	12.70	-	11.18	-	-	THT-251-492-1.5-SC	BBP12	R6400	1500	1
⊠	B-499	F N A	25.40	12.70	-	-	-	-	B33-5-499	i3300, i5300	B30 Monocolour	5000	3
▲	B-492	F N H L	25.40	12.70	-	-	-	-	B33-59-492	i3300	B30 Monocolour	2500	1
⊕	B-7425J	F N A H	25.40	12.70	-	-	-	-	J-251-7425J	J7300		1	1
▲	B-7425J	F N A H	25.40	12.70	-	-	-	-	J-59-7425J	J7300		1	1
▲	B-499	F N A	25.40	12.70	-	-	-	-	M21-131-499	M210-LAB, M211	R4300	1	1
▲	B-423	F AH	25.40	12.70	-	-	-	-	M21-17-423	M210-LAB, M211	R6000HF	1	1
▲	B-423	F A	25.40	12.70	-	-	-	-	M6-17-423	M610, M611	R6000HF, R6200, R4400	500	1
▲	B-423	F AH	25.40	12.70	-	-	-	-	M7-17-423	M710	R6000HF	500	1
▲	B-492	F N H L	25.40	12.70	-	-	-	-	M7-17-492	M710	R6400	500	1
▲	B-492	F N H L	25.40	12.70	-	-	-	-	THT-59-492-10	BBP12, i7100, i5100	R6400	10000	1
▲	B-492	F N H L	25.40	12.70	-	-	-	-	THT-59-492-2.5-SC	BBP12	R6400	2500	1
▷	B-461	F N A H S L	55.88	12.70	-	-	19.05	12.70	B33-127-461	i3300	B30 Monocolour	1500	3
▷	B-461	F N A H S L	55.88	12.70	-	-	19.05	12.70	THT-127-461-1.5-SC	BBP12	R7950	1500	1
▷	B-461	F N A H S L	55.88	12.70	-	-	19.05	12.70	THT-127-461-3	BBP12, i7100, i5100	R4300, R7950	3000	1

>>

<b>F</b> Freezer environment	<b>N</b> Liquid nitrogen environment	<b>A</b> Autoclave environment	<b>H</b> Hot water bath (100°C)	<b>S</b> Self-laminating label	<b>L</b> Low-profile (extremely thin) label	<b>R</b> Removable
------------------------------	--------------------------------------	--------------------------------	---------------------------------	--------------------------------	---	--------------------



# Conical / Large Tube Labels

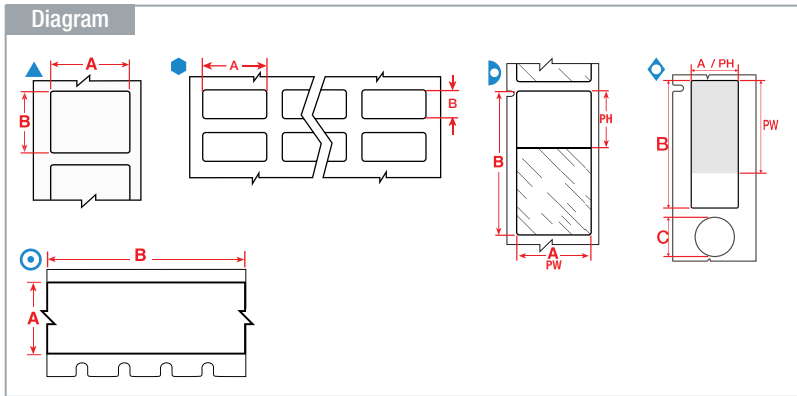

Labels are shown per vial / tube size and in order of label width.

The background colours in the Order Reference column represent the material colour.

See page 54 for Brady's range of label printers.

Diagram	Material	Special Properties	Label Width A (mm)	Label Height B (mm)	Label Length B (m)	Diameter C (mm)	Printable Area Width (mm)	Printable Area Height PH (mm)	Order Reference	Printer Compatibility	Printer Ribbon Series	Labels per Roll	Labels per Row
<b>1.5 ml</b>													
	B-461	<b>FNAHSL</b>	15.24	41.28	-	-	15.24	25.40	M7-76-461	M710	R6200	500	1
	B-499	<b>FNA</b>	19.05	6.35	-	-	-	-	B33-1-499	i3300, i5300	B30 Monocolour	10000	4
	B-499	<b>FNA</b>	19.05	19.05	-	-	-	-	B33-254-499	i3300, i5300	B30 Monocolour	1000	1
	B-499	<b>FNA</b>	19.05	23.80	-	-	-	-	B33-91-499	i3300, i5300	B30 Monocolour	2500	4
	B-499	<b>FNA</b>	19.05	-	4.88	-	-	-	M21-750-499	M210-LAB, M211	R4300	1	-
	B-499	<b>FNA</b>	19.05	-	4.88	-	-	-	M4C-750-499	M511, BMP41, BMP51	R4300	1	-
	B-461	<b>FNAHSL</b>	19.05	-	6.40	-	-	-	M21-750-461-AW**	M210-LAB, M211	R4300	1	-
	B-423	<b>F A</b>	25.40	4.75	-	-	-	-	M6-14-423	M610, M611	R6000HF, R6200, R4400	750	1
	B-423	<b>F AH</b>	25.40	4.75	-	-	-	-	M7-14-423	M710	R6000HF	750	1
	B-423	<b>F AH</b>	25.40	4.75	-	-	-	-	THT-41-423-10	BBP12, i7100, i5100	R6000HF	10000	3
	B-423	<b>F AH</b>	25.40	6.35	-	-	-	-	THT-51-423-10	BBP12, i7100, i5100	R6000HF	10000	3
	B-423	<b>F A</b>	25.40	6.99	-	-	-	-	M6-15-423	M610, M611	R6000HF, R6200, R4400	750	1
	B-423	<b>F AH</b>	25.40	6.99	-	-	-	-	M7-15-423	M710	R6000HF	750	1
	B-499	<b>FNA</b>	25.40	19.05	-	-	-	-	B33-88-499	i3300, i5300	B30 Monocolour	2500	2
	B-7425J	<b>FNAH</b>	25.40	19.05	-	-	-	-	J-88-7425J	J7300		1	2
	B-423	<b>F AH</b>	25.40	19.05	-	-	-	-	M21-18-423	M210-LAB, M211	R6000HF	1	1
	B-499	<b>FNA</b>	25.40	19.05	-	-	-	-	M21-18-499	M210-LAB, M211	R4300	1	1
	B-492	<b>FN H L</b>	25.40	19.05	-	-	-	-	THT-88-492-2.5-SC	BBP12	R6400	2500	2
	B-492	<b>FN H L</b>	25.40	19.05	-	-	-	-	THT-88-492-5	BBP12, i7100, i5100	R6400	5000	2
	B-461	<b>FNAHSL</b>	66.68	15.24	-	-	25.40	15.24	THT-153-461-1.5-SC	BBP12	R7950	1500	1
	B-461	<b>FNAHSL</b>	66.68	15.24	-	-	25.40	15.24	THT-153-461-3	BBP12, i7100, i5100	R4300, R7950	3000	1
<b>2.0 ml</b>													
	B-499	<b>FNA</b>	6.35	36.50	-	-	-	-	B33-90-499	i3300, i5300	B30 Monocolour	2500	6
	B-461	<b>FNAHSL</b>	15.00	40.00	-	-	15.00	29.97	BPTLAB-21-461-2.5	BBP12	R7950	2500	1
	B-461	<b>FNAHSL</b>	15.24	38.10	-	-	15.24	33.00	M7-100-461	M710	R6200	500	1
	B-461	<b>FNAHSL</b>	15.24	38.10	-	-	15.24	33.02	B33-628-461	i3300	B30-R4300	2500	2
	B-461	<b>FNAHSL</b>	15.24	38.10	-	-	15.24	33.02	BPT-628-461	BBP12	R7950	2500	2
	B-461	<b>FNAHSL</b>	15.24	66.68	-	-	15.24	25.40	B33-612-461	i3300	B30-R4300	1500	3
	B-461	<b>FNAHSL</b>	15.24	66.68	-	-	15.24	25.40	BPT-612-461	BBP12	R7950	1500	3
	B-461	<b>FNAHSL</b>	19.05	38.10	-	-	19.05	33.02	B33-629-461	i3300	B30-R4300	2500	2
	B-492	<b>FN H L</b>	22.86	25.40	-	-	-	-	M5-156-492	M511, BMP51	R6400	180	-
	B-492	<b>FN H L</b>	22.86	25.40	-	-	-	-	THT-180-492-3	BBP12, i7100, i5100	R6400	3000	1
	B-494	<b>FN H</b>	25.40	9.53	-	9.53	-	-	THT-304-494-3-BL	i5100, i7100	R6400	3000	1
	B-494	<b>FN H</b>	25.40	9.53	-	9.53	-	-	THT-304-494-3-GN	i5100, i7100	R6400	3000	1
	B-494	<b>FN H</b>	25.40	9.53	-	9.53	-	-	THT-304-494-3-OR	i5100, i7100	R6400	3000	1
	B-494	<b>FN H</b>	25.40	9.53	-	9.53	-	-	THT-304-494-3-PK	i5100, i7100	R6400	3000	1
	B-494	<b>FN H</b>	25.40	9.53	-	9.53	-	-	THT-304-494-3-RD	i5100, i7100	R6400	3000	1

\*\*AW = All White / no transparent area.

>>

<b>F</b> Freezer environment	<b>N</b> Liquid nitrogen environment	<b>A</b> Autoclave environment	<b>H</b> Hot water bath (100°C)	<b>S</b> Self-laminating label	<b>L</b> Low-profile (extremely thin) label	<b>R</b> Removable
------------------------------	--------------------------------------	--------------------------------	---------------------------------	--------------------------------	---	--------------------

# Conical / Large Tube Labels

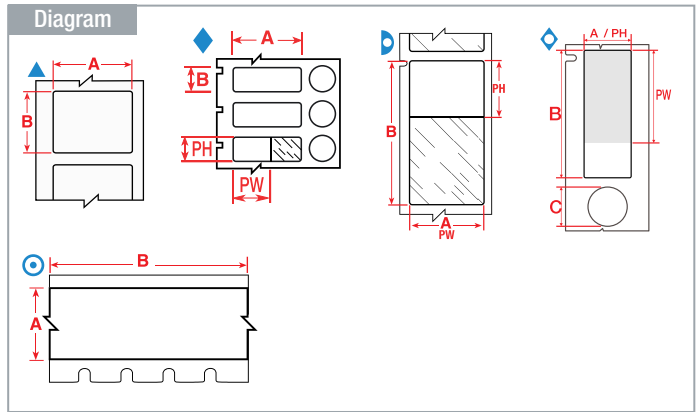

The background colours in the Order Reference column represent the material colour.

See page 54 for Brady's range of label printers.

Labels are shown per vial / tube size and in order of label width.

Diagram	Material	Special Properties	Label Width A (mm)	Label Height B (mm)	Label Length B (m)	Diameter C (mm)	Printable Area Width PW (mm)	Printable Area Height PH (mm)	Order Reference	Printer Compatibility	Printer Ribbon Series	Labels per Roll	Labels per Row
<b>2.0 ml</b>													
◇	B-494	<b>F N H</b>	25.40	9.53	-	9.53	-	-	THT-304-494-3-YL	i5100, i7100	R6400	3000	1
◇	B-494	<b>F N H</b>	25.40	12.70	-	11.18	-	-	THT-306-494-3-BL	i5100, i7100	R6400	3000	1
◇	B-494	<b>F N H</b>	25.40	12.70	-	11.18	-	-	THT-306-494-3-GN	i5100, i7100	R6400	3000	1
◇	B-494	<b>F N H</b>	25.40	12.70	-	11.18	-	-	THT-306-494-3-OR	i5100, i7100	R6400	3000	1
◇	B-494	<b>F N H</b>	25.40	12.70	-	11.18	-	-	THT-306-494-3-PK	i5100, i7100	R6400	3000	1
◇	B-494	<b>F N H</b>	25.40	12.70	-	11.18	-	-	THT-306-494-3-RD	i5100, i7100	R6400	3000	1
◇	B-494	<b>F N H</b>	25.40	12.70	-	11.18	-	-	THT-306-494-3-YL	i5100, i7100	R6400	3000	1
▲	B-494	<b>F N H</b>	25.40	12.70	-	-	-	-	B33-310-494-BL	i3300, i5300	R6400	2500	1
▲	B-494	<b>F N H</b>	25.40	12.70	-	-	-	-	B33-310-494-GN	i3300, i5300	R6400	2500	1
▲	B-494	<b>F N H</b>	25.40	12.70	-	-	-	-	B33-310-494-OR	i3300, i5300	R6400	2500	1
▲	B-494	<b>F N H</b>	25.40	12.70	-	-	-	-	B33-310-494-PK	i3300, i5300	R6400	2500	1
▲	B-494	<b>F N H</b>	25.40	12.70	-	-	-	-	B33-310-494-RD	i3300, i5300	R6400	2500	1
▲	B-494	<b>F N H</b>	25.40	12.70	-	-	-	-	B33-310-494-YL	i3300, i5300	R6400	2500	1
▲	B-494	<b>F N H</b>	25.40	12.70	-	-	-	-	BPT-310-494-2.5-BL	BBP12	R6400	2500	1
▲	B-494	<b>F N H</b>	25.40	12.70	-	-	-	-	BPT-310-494-2.5-GN	BBP12	R6400	2500	1
▲	B-494	<b>F N H</b>	25.40	12.70	-	-	-	-	BPT-310-494-2.5-OR	BBP12	R6400	2500	1
▲	B-494	<b>F N H</b>	25.40	12.70	-	-	-	-	BPT-310-494-2.5-PK	BBP12	R6400	2500	1
▲	B-494	<b>F N H</b>	25.40	12.70	-	-	-	-	BPT-310-494-2.5-RD	BBP12	R6400	2500	1
▲	B-494	<b>F N H</b>	25.40	12.70	-	-	-	-	BPT-310-494-2.5-YL	BBP12	R6400	2500	1
▲	B-494	<b>F N H</b>	25.40	12.70	-	-	-	-	THT-310-494-10-BL	i5100, i7100	R6400	10000	1
▲	B-494	<b>F N H</b>	25.40	12.70	-	-	-	-	THT-310-494-10-GN	i5100, i7100	R6400	10000	1
▲	B-494	<b>F N H</b>	25.40	12.70	-	-	-	-	THT-310-494-10-OR	i5100, i7100	R6400	10000	1
▲	B-494	<b>F N H</b>	25.40	12.70	-	-	-	-	THT-310-494-10-PK	i5100, i7100	R6400	10000	1
▲	B-494	<b>F N H</b>	25.40	12.70	-	-	-	-	THT-310-494-10-RD	i5100, i7100	R6400	10000	1
▲	B-494	<b>F N H</b>	25.40	12.70	-	-	-	-	THT-310-494-10-YL	i5100, i7100	R6400	10000	1
▲	B-492	<b>F N H L</b>	25.40	25.40	-	-	-	-	B33-179-492	i3300	B30 Monocolour	1900	1
▲	B-7425J	<b>F N A H</b>	25.40	25.40	-	-	-	-	J-179-7425J	J7300		1	1
▲	B-492	<b>F N H L</b>	25.40	25.40	-	-	-	-	THT-179-492-2.5-SC	BBP12	R6400	2500	1
▲	B-492	<b>F N H L</b>	25.40	25.40	-	-	-	-	THT-179-492-3	BBP12, i7100, i5100	R6400	3000	1
▶	B-461	<b>F N A H S L</b>	25.40	66.68	-	-	25.40	25.40	M7-115-461	M710	R6200	100	1
○	B-499	<b>F N A</b>	25.40	-	4.88	-	-	-	M5C-1000-499	M511, BMP51	R4300	1	-
○	B-423	<b>F A H</b>	25.40	-	7.62	-	-	-	MAC-1000-423	M410, M510, M511	R6200	1	-
○	B-7425	<b>F N A H</b>	25.40	-	7.62	-	-	-	MAC-1000-7425	M410, M510, M511	R4300	1	-
○	B-461	<b>F N A H S L</b>	25.40	-	7.62	-	-	-	M5C-1000-461	M511, BMP51	R4300	1	-
○	B-499	<b>F N A</b>	25.40	-	9.14	-	-	-	M7C-1000-499	M710	R4300, R6000HF, R6200	1	1
▲	B-7425J	<b>F N A H</b>	33.02	15.24	-	-	-	-	J-256-7425J	J7300		1	1
◆	B-461	<b>F A H S L</b>	40.00	15.00	-	9.53	29.97	15.00	M7-101-461	M710	R6200	250	1

>>

**F** Freezer environment    **N** Liquid nitrogen environment    **A** Autoclave environment    **H** Hot water bath (100°C)    **S** Self-laminating label    **L** Low-profile (extremely thin) label    **R** Removable

# Conical / Large Tube Labels

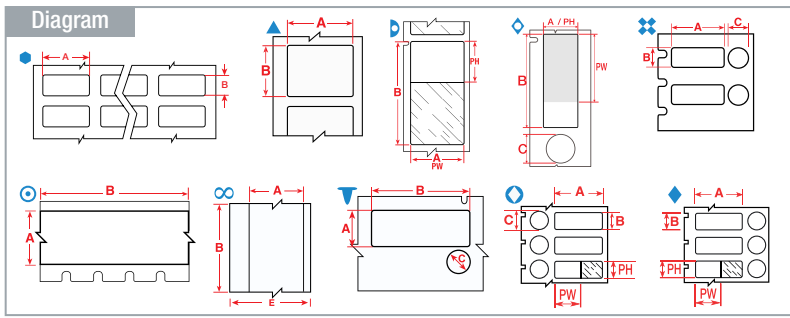

The background colours in the Order Reference column represent the material colour.

See page 54 for Brady's range of label printers.

Labels are shown per vial / tube size and in order of label width.

Diagram	Material	Special Properties	Label Width A (mm)	Label Height B (mm)	Label Length B (m)	Diameter C (mm)	Printable Area Width PW (mm)	Printable Area Height PH (mm)	Order Reference	Printer Compatibility	Printer Ribbon Series	Labels per Roll	Labels per Row
<b>4.0 ml</b>													
●	B-499	<b>FNA</b>	12.70	36.50	-	-	-	-	B33-87-499	i3300, i5300	B30 Monocolour	2500	6
●	B-7425J	<b>FNAH</b>	12.70	38.10	-	-	-	-	J-37-7425J	J7300		1	2
▲	B-499	<b>FNA</b>	12.70	38.10	-	-	-	-	M6-29-499	M610, M611	R4300, R6200	500	1
▲	B-499	<b>FNA</b>	12.70	38.10	-	-	-	-	M7-29-499	M710	R4300, R6000HF, R6200	500	1
▲	B-492	<b>FNHL</b>	12.70	41.91	-	-	-	-	M5-124-492	M511, BMP51	R6400	180	-
◇	B-461	<b>FAHSL</b>	15.24	41.28	-	12.70	15.24	30.00	M7-116-461	M710	R6200	150	1
▷	B-461	<b>FNAHSL</b>	15.24	48.26	-	-	15.24	39.88	B33-638-461	i3300	B30-R4300	2000	1
▷	B-461	<b>FNAHSL</b>	15.24	48.26	-	-	15.24	39.88	BPT-638-461	BBP12	R7950	2000	1
▷	B-461	<b>FNAHSL</b>	15.24	48.26	-	-	15.24	40.00	M7-119-461	M710	R6200	500	1
●	B-499	<b>FNA</b>	20.32	36.50	-	-	-	-	B33-165-499	i3300	B30 Monocolour	2500	4
●	B-499	<b>FNA</b>	20.32	36.50	-	-	-	-	TH-69-499-3	BBP12, i7100, i5100	R4900	3000	2
●	B-499	<b>FNA</b>	22.86	38.10	-	-	-	-	BPT-618-499	BBP12	R7950	3000	3
●	B-499	<b>FNA</b>	25.40	36.50	-	-	-	-	B33-621-499	i3300	B30-R6000	3000	3
●	B-499	<b>FNA</b>	25.40	36.50	-	-	-	-	B33-89-499	i3300, i5300	B30 Monocolour	2300	3
●	B-499	<b>FNA</b>	25.40	36.50	-	-	-	-	BPT-621-499	BBP12	R7950	3000	3
▲	B-492	<b>FNHL</b>	25.40	48.26	-	-	-	-	M5-78-492	M511, BMP51	R6400	100	-
∞	B-7425J	<b>FNAH</b>	28.58	-	45.72	-	-	-	JC-1125-7425J	J7300		1	1
◎	B-461	<b>FNAHSL</b>	31.75	-	7.62	-	-	-	M5C-1250-461	M511, BMP51	R4300	1	-
▷	B-461	<b>FNAHSL</b>	34.93	45.72	-	-	34.93	39.88	B33-632-461	i3300	B30-R4300	1500	1
▷	B-461	<b>FNAHSL</b>	34.93	45.72	-	-	34.93	39.88	BPT-632-461	BBP12	R7950	2000	1
▷	B-461	<b>FNAHSL</b>	38.10	19.05	-	-	38.10	19.05	BPT-629-461	BBP12	R7950	2500	2
▲	B-499	<b>FNA</b>	38.10	19.05	-	-	-	-	B33-136-499	i3300	B30 Monocolour	1500	1
▲	B-7425J	<b>FNAH</b>	38.10	19.05	-	-	-	-	J-136-7425J	J7300		1	1
▲	B-499	<b>FNA</b>	38.10	19.05	-	-	-	-	M21-136-499	M210-LAB, M211	R4300	1	1
▲	B-423	<b>FAH</b>	38.10	19.05	-	-	-	-	M21-30-423	M210-LAB, M211	R6000HF	1	1
▲	B-499	<b>FNA</b>	38.10	19.05	-	-	-	-	M6-30-499	M610, M611	R4300, R6200	250	1
▲	B-499	<b>FNA</b>	38.10	19.05	-	-	-	-	M7-30-499	M710	R4300, R6000HF, R6200	250	1
▲	B-499	<b>FNA</b>	38.10	19.05	-	-	-	-	TH-136-499-1.5-SC	BBP12	R7950, R4300, R4900	1500	1
▲	B-499	<b>FNA</b>	38.10	19.05	-	-	-	-	TH-136-499-3	BBP12, i7100, i5100	R4900	3000	1
▲	B-7425J	<b>FNAH</b>	38.10	25.40	-	-	-	-	J-235-7425J	J7300		1	1
▲	B-423	<b>FA</b>	38.10	25.40	-	-	-	-	M6-31-423	M610, M611	R6000HF, R6200, R4400	250	1
▲	B-499	<b>FNA</b>	38.10	25.40	-	-	-	-	M6-31-499	M610, M611	R4300, R6200	250	1
▲	B-423	<b>FAH</b>	38.10	25.40	-	-	-	-	M7-31-423	M710	R6000HF	250	1
▲	B-499	<b>FNA</b>	38.10	25.40	-	-	-	-	M7-31-499	M710	R4300, R6000HF, R6200	250	1
▲	B-499	<b>FNA</b>	38.10	31.75	-	-	-	-	M5-132-499	M511, BMP51	R4300	160	-
▲	B-7425J	<b>FNAH</b>	38.10	44.45	-	-	-	-	J-258-7425J	J7300		1	1
◎	B-7425	<b>FNAH</b>	38.10	-	7.62	-	-	-	M5C-1500-7425	M510, M511	R4300	1	-
◇	B-461	<b>FAHSL</b>	40.00	15.00	-	9.00	40.00	15.00	BPTLAB-20-461-2.5	BBP12	R7950	2500	1
✖	B-492	<b>FHL</b>	41.28	15.24	-	9.53	-	-	B33-190-492	i3300	B30 Monocolour	1500	1
▽	B-492	<b>FHL</b>	41.28	15.24	-	9.53	-	-	M5-95-492	M511, BMP51	R6400	200	-
✖	B-492	<b>FHL</b>	41.28	15.24	-	9.53	-	-	TH-190-492-3	BBP12, i7100, i5100	R6400	3000	1
◇	B-461	<b>FAHSL</b>	41.28	15.24	-	12.70	41.28	15.24	B33-608-461	i3300	B30-R4300	1000	1
◇	B-461	<b>FAHSL</b>	41.28	15.24	-	12.70	41.28	15.24	BPT-608-461	BBP12	R7950	1000	1
✖	B-499	<b>FA</b>	41.28	15.24	-	12.70	-	-	BPT-608-499	BBP12	R7950	1000	1
▷	B-461	<b>FNAHSL</b>	41.28	15.24	-	-	25.40	15.24	B33-133-461	i3300	B30 Monocolour	1500	3
▷	B-461	<b>FNAHSL</b>	41.28	15.24	-	-	25.40	15.24	TH-133-461-1.5-SC	BBP12	R7950	1500	1

>>

# Conical / Large Tube Labels

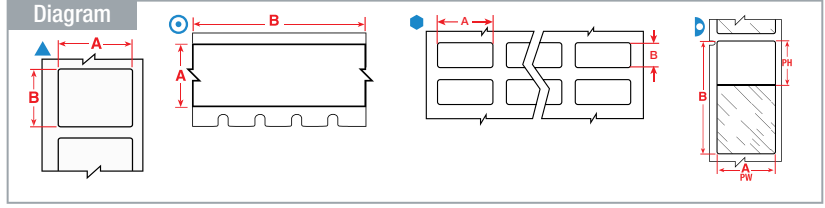

Labels are shown per vial / tube size and in order of label width.

The background colours in the Order Reference column represent the material colour.

See page 54 for Brady's range of label printers.

Diagram	Material	Special Properties	Label Width A (mm)	Label Height B (mm)	Label Length B (m)	Diameter C (mm)	Printable Area Width PW (mm)	Printable Area Height PH (mm)	Order Reference	Printer Compatibility	Printer Ribbon Series	Labels per Roll	Labels per Row
<b>4.0 ml</b>													
▶	B-461	FNAHSL	41.28	15.24	-	-	25.40	15.24	THT-133-461-3	BBP12, i7100, i5100	R4300, R7950	3000	1
▲	B-490	FNHL	41.28	15.24	-	-	-	-	B33-155-490	i3300	B30 Monocolour	1500	1
▲	B-492	FNHL	41.28	15.24	-	-	-	-	B33-155-492	i3300	B30 Monocolour	1500	1
▲	B-490	FNHL	41.28	15.24	-	-	-	-	M7-76-490	M710	R4300	500	1
▲	B-490	FNHL	41.28	15.24	-	-	-	-	THT-155-490-1.5-SC	BBP12	R7950	1500	1
▲	B-490	FNHL	41.28	15.24	-	-	-	-	THT-155-490-3	BBP12, i7100, i5100	R4300, R7950	3000	1
▲	B-492	FNHL	41.28	15.24	-	-	-	-	THT-155-492-3	BBP12, i7100, i5100	R6400	3000	1
⊙	B-499	FNA	48.26	-	9.14	-	-	-	M7C-1900-499	M710	R4300, R6000HF, R6200	1	1
▲	B-490	FNHL	50.80	6.35	-	-	-	-	B33-151-490	i3300	B30 Monocolour	2500	1
▶	B-461	FNAHSL	66.68	25.40	-	-	25.40	25.40	B33-276-461	i3300	B30 Monocolour	1500	2
▶	B-461	FNAHSL	66.68	25.40	-	-	25.40	25.40	BM-75-461	M610, M611, M710	R4300, R6200	1000	1
▶	B-461	FNAHSL	66.68	25.40	-	-	25.40	25.40	THT-131-461-1.5-SC	BBP12	R7950	1500	1
▶	B-461	FNAHSL	66.68	25.40	-	-	25.40	25.40	THT-131-461-3	BBP12, i7100, i5100	R4300, R7950	3000	1
▶	B-461	FNAHSL	88.90	38.10	-	-	31.75	38.10	B33-134-461	i3300	B30 Monocolour	1000	1
▶	B-461	FNAHSL	88.90	38.10	-	-	31.75	38.10	THT-134-461-3	BBP12, i7100, i5100	R4300, R7950	3000	1
<b>8.0 ml</b>													
▶	B-461	FNAHSL	15.24	66.68	-	-	15.24	25.40	M7-86-461	M710	R6200	100	1
▲	B-494	FNH	25.40	25.40	-	-	25.40	22.23	THT-179-494-BL	i7100, i5100, BBP12	R6400	3000	1
▲	B-494	FNH	25.40	25.40	-	-	25.40	22.23	THT-179-494-GN	i7100, i5100, BBP12	R6400	3000	1
▲	B-494	FNH	25.40	25.40	-	-	25.40	22.23	THT-179-494-OR	i7100, i5100, BBP12	R6400	3000	1
▲	B-494	FNH	25.40	25.40	-	-	25.40	22.23	THT-179-494-PK	i7100, i5100, BBP12	R6400	3000	1
▲	B-494	FNH	25.40	25.40	-	-	25.40	22.23	THT-179-494-RD	i7100, i5100, BBP12	R6400	3000	1
▲	B-494	FNH	25.40	25.40	-	-	25.40	22.23	THT-179-494-YL	i7100, i5100, BBP12	R6400	3000	1
▲	B-490	FNHL	25.40	44.45	-	-	-	-	M6-203-490	M610, M611	R4300	250	1
▲	B-423	FAH	25.40	50.80	-	-	-	-	BM-20-423	M610, M611, M710	R6000HF	1000	1
⬤	B-499	FNA	25.40	66.68	-	-	-	-	B33-625-499	i3300	B30-R6000	1500	3
⬤	B-499	FNA	25.40	66.68	-	-	-	-	BPT-625-499	BBP12	R7950	1500	3
▲	B-499	FNA	25.40	76.20	-	-	-	-	M4-22-499	M410, M510, M511	R4300	100	1
▲	B-494	FNH	41.28	15.24	-	-	-	-	B33-302-494-BL	i3300, i5300	R6400	1500	1
▲	B-494	FNH	41.28	15.24	-	-	-	-	B33-302-494-GN	i3300, i5300	R6400	1500	1
▲	B-494	FNH	41.28	15.24	-	-	-	-	B33-302-494-OR	i3300, i5300	R6400	1500	1
▲	B-494	FNH	41.28	15.24	-	-	-	-	B33-302-494-PK	i3300, i5300	R6400	1500	1
▲	B-494	FNH	41.28	15.24	-	-	-	-	B33-302-494-RD	i3300, i5300	R6400	1500	1
▲	B-494	FNH	41.28	15.24	-	-	-	-	B33-302-494-YL	i3300, i5300	R6400	1500	1
▲	B-492	FNHL	44.45	25.40	-	-	-	-	M5-125-492	M511, BMP51	R6400	180	-
▲	B-461	FNAHL	48.26	25.40	-	-	48.26	-	B33-636-461AW**	i3300	B30-R4300	2000	1
▲	B-461	FNAHL	48.26	25.40	-	-	48.26	-	BPT-636-461-AW**	BBP12	R7950	2000	1
▲	B-490	FNHL	48.26	25.40	-	-	-	-	B33-156-490	i3300	B30 Monocolour	1500	1
▲	B-492	FNHL	48.26	25.40	-	-	-	-	B33-156-492	i3300	B30 Monocolour	1500	1
▲	B-499	FNA	48.26	25.40	-	-	-	-	M4-128-499	M511, BMP41, BMP51	R4300	100	-
▲	B-488	FA	48.26	25.40	-	-	-	-	M6-78-488	M610, M611	R4300	250	1
▲	B-499	FNA	48.26	25.40	-	-	-	-	M6-78-499	M610, M611	R4300, R6200	250	1
▲	B-492	FNHL	48.26	25.40	-	-	-	-	M7-78-492	M710	R6400	250	1
▲	B-499	FNA	48.26	25.40	-	-	-	-	M7-78-499	M710	R4300, R6000HF, R6200	250	1
▲	B-490	FNHL	48.26	25.40	-	-	-	-	THT-156-490-1.5-SC	BBP12	R7950	1500	1
▲	B-490	FNHL	48.26	25.40	-	-	-	-	THT-156-490-3	BBP12, i7100, i5100	R4300, R7950	3000	1

\*\*AW = All White / no transparent area.



<b>F</b> Freezer environment	<b>N</b> Liquid nitrogen environment	<b>A</b> Autoclave environment	<b>H</b> Hot water bath (100°C)	<b>S</b> Self-laminating label	<b>L</b> Low-profile (extremely thin) label	<b>R</b> Removable
------------------------------	--------------------------------------	--------------------------------	---------------------------------	--------------------------------	---	--------------------

# Conical / Large Tube Labels

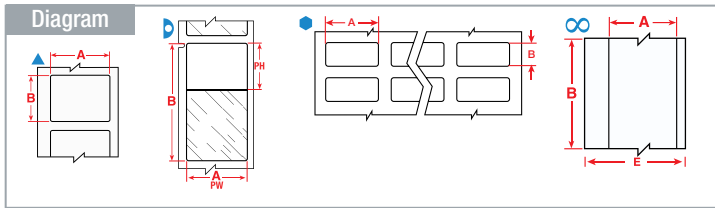

The background colours in the Order Reference column represent the material colour.

See page 54 for Brady's range of label printers.

Labels are shown per vial / tube size and in order of label width.

Diagram	Material	Special Properties	Label Width A (mm)	Label Height B (mm)	Label Length B (m)	Diameter C (mm)	Printable Area Width PW (mm)	Printable Area Height PH (mm)	Order Reference	Printer Compatibility	Printer Ribbon Series	Labels per Roll	Labels per Row
<b>8.0 ml</b>													
▲	B-492	<b>F N H L</b>	48.26	25.40	-	-	-	-	THT-156-492-1.5-SC	BBP12	R6400	1500	1
▲	B-492	<b>F N H L</b>	48.26	25.40	-	-	-	-	THT-156-492-3	BBP12, i7100, i5100	R6400	3000	1
▲	B-494	<b>F N H</b>	48.26	25.40	-	-	-	-	THT-303-494-3-BL	i5100, i7100	R6400	3000	1
▲	B-494	<b>F N H</b>	48.26	25.40	-	-	-	-	THT-303-494-3-GN	i5100, i7100	R6400	3000	1
▲	B-494	<b>F N H</b>	48.26	25.40	-	-	-	-	THT-303-494-3-OR	i5100, i7100	R6400	3000	1
▲	B-494	<b>F N H</b>	48.26	25.40	-	-	-	-	THT-303-494-3-PK	i5100, i7100	R6400	3000	1
▲	B-494	<b>F N H</b>	48.26	25.40	-	-	-	-	THT-303-494-3-RD	i5100, i7100	R6400	3000	1
▲	B-494	<b>F N H</b>	48.26	25.40	-	-	-	-	THT-303-494-3-YL	i5100, i7100	R6400	3000	1
▲	B-499	<b>F N A</b>	50.80	25.40	-	-	-	-	B33-137-499	i3300	B30 Monocolour	1100	1
▲	B-7425J	<b>F N A H</b>	50.80	25.40	-	-	-	-	J-137-7425J	J7300		1	1
▲	B-499	<b>F N A</b>	50.80	25.40	-	-	-	-	THT-137-499-1.5-SC	BBP12	R7950, R4300, R4900	1500	1
▲	B-499	<b>F N A</b>	50.80	25.40	-	-	-	-	THT-137-499-3	BBP12, i7100, i5100	R4900	3000	1
<b>15.0 ml</b>													
▲	B-423	<b>F A</b>	25.40	50.80	-	-	-	-	M6-20-423	M610, M611	R6000HF, R6200, R4400	100	1
▲	B-423	<b>F A H</b>	25.40	50.80	-	-	-	-	M7-20-423	M710	R6000HF	100	1
▲	B-490	<b>F N H L</b>	38.10	55.88	-	-	-	-	M5-113-490	M511, BMP51	R4300	140	-
▲	B-490	<b>F N H L</b>	38.10	55.88	-	-	-	-	M6-113-490	M610, M611	R4300	100	1
▲	B-490	<b>F N H L</b>	55.88	38.10	-	-	-	-	THT-157-490-1.5-SC	BBP12	R7950	1500	1
▲	B-490	<b>F N H L</b>	55.88	38.10	-	-	-	-	THT-157-490-3	BBP12, i7100, i5100	R4300, R7950	3000	1
▷	B-461	<b>F N A H S L</b>	57.15	38.10	-	-	31.75	38.10	M5-129-461	M511, BMP51	R4300	140	-
▲	B-7425J	<b>F N A H</b>	76.20	25.40	-	-	-	-	J-18-7425J	J7300		1	1
▲	B-423	<b>F A</b>	76.20	25.40	-	-	-	-	M6-22-423	M610, M611	R6000HF, R6200, R4400	100	1
▲	B-423	<b>F A H</b>	76.20	25.40	-	-	-	-	M7-22-423	M710	R6000HF	100	1
▷	B-461	<b>F N A H S L</b>	95.25	38.10	-	-	31.75	38.10	M5-119-461	M511, BMP51	R4300	80	-
▷	B-461	<b>F N A H S L</b>	133.35	25.40	-	-	38.10	25.40	B33-139-461	i3300	B30 Monocolour	650	2
▷	B-461	<b>F N A H S L</b>	133.35	25.40	-	-	38.10	25.40	THT-139-461-2	BBP12, i7100, i5100	R4300, R7950	2000	2
<b>25.0 ml</b>													
●	B-499	<b>F N A</b>	25.40	63.50	-	-	-	-	B33-325-499	i3300, i5300	B30 Monocolour	700	2
▲	B-499	<b>F N A</b>	25.40	63.50	-	-	-	-	M7-21-499	M710	R4300, R6000HF, R6200	100	1
▲	B-423	<b>F A H</b>	50.80	19.05	-	-	-	-	M21-137-423	M210-LAB, M211	R6000HF	1	1
▲	B-499	<b>F N A</b>	50.80	19.05	-	-	-	-	M21-137-499	M210-LAB, M211	R4300	1	1
▲	B-461	<b>F N A H L</b>	57.15	19.05	-	-	57.15	-	B33-642-461AW**	i3300	B30-R4300	2000	1
▲	B-461	<b>F N A H L</b>	57.15	19.05	-	-	57.15	-	BPT-642-461-AW**	BBP12	R7950	2000	1
∞	B-7425J	<b>F N A H</b>	57.15	-	45.72	-	-	-	JC-2250-7425J	J7300		1	1
▷	B-461	<b>F N A H S L</b>	88.90	38.10	-	-	25.40	15.24	M6-77-461	M610, M611	R4300, R6200	100	1
▲	B-461	<b>F N A H L</b>	88.90	38.10	-	-	88.90	-	B33-650-461AW**	i3300	B30-R4300	2000	1
▲	B-461	<b>F N A H L</b>	88.90	38.10	-	-	88.90	-	BPT-650-461-AW**	BBP12	R7950	2000	1
<b>50.0 ml</b>													
▲	B-498	<b>F R</b>	25.40	12.70	-	-	-	-	M7-17-498	M710	R6200	500	1
●	B-499	<b>F N A</b>	25.40	101.60	-	-	-	-	B33-326-499	i3300, i5300	B30 Monocolour	450	2
▲	B-490	<b>F N H L</b>	38.10	95.25	-	-	-	-	M5-114-490	M511, BMP51	R4300	80	-
▲	B-490	<b>F N H L</b>	38.10	98.43	-	-	-	-	M6-114-490	M610, M611	R4300	100	1
●	B-499	<b>F N A</b>	38.10	101.60	-	-	-	-	B33-327-499	i3300, i5300	B30 Monocolour	450	2
●	B-499	<b>F N A</b>	38.10	152.40	-	-	-	-	B33-328-499	i3300, i5300	B30 Monocolour	300	2
▲	B-490	<b>F N H L</b>	95.25	38.10	-	-	-	-	THT-158-490-1.5-SC	BBP12	R7950	1500	1
▲	B-490	<b>F N H L</b>	95.25	38.10	-	-	-	-	THT-158-490-3	BBP12, i7100, i5100	R4300, R7950	3000	1

\*\*AW = All White / no transparent area.

<b>F</b> Freezer environment	<b>N</b> Liquid nitrogen environment	<b>A</b> Autoclave environment	<b>H</b> Hot water bath (100°C)	<b>S</b> Self-laminating label	<b>L</b> Low-profile (extremely thin) label	<b>R</b> Removable
------------------------------	--------------------------------------	--------------------------------	---------------------------------	--------------------------------	---	--------------------



## Slide Labels

Brady offers labels specifically designed to identify slides and to resist exposure to harsh chemicals during the slide staining process. They perform well in the hematoxylin and eosin slide staining process and offer superior chemical resistance also useful in other laboratory contexts.

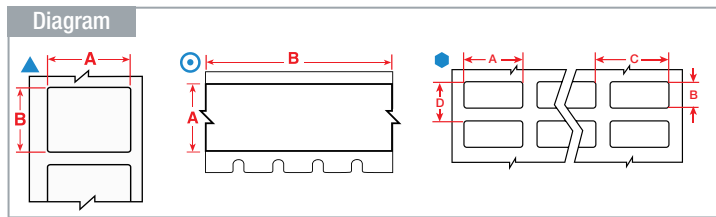

- F** Freezer environment
- N** Liquid nitrogen environment
- A** Autoclave environment
- H** Hot water bath (100°C)
- S** Self-laminating label
- L** Low-profile (extremely thin) label
- R** Removable

Labels are shown in order of label width.

The background colours in the Order Reference column represent the material colour.

See page 54 for Brady's range of label printers.

Diagram	Material	Special Properties	Label Width A (mm)	Label Height B (mm)	Label Length B (m)	Order Reference	Printer Compatibility	Printer Ribbon Series	Labels per Roll	Labels per Row
⊙	B-488	<b>F A</b>	9.53	–	6.40	M21-375-488	M210-LAB, M211	R4300	1	–
▲	B-492	<b>F N H L</b>	12.70	41.91	–	M6-124-492	M610, M611	R4300, R6400	500	1
⊙	B-488	<b>F A</b>	12.70	–	6.40	M21-500-488	M210-LAB, M211	R4300	1	–
▲	B-488	<b>F A</b>	19.05	22.86	–	M6-80-488	M610, M611	R4300	250	1
▲	B-488	<b>F A</b>	19.05	22.86	–	M7-80-488	M710	R4300, R6200	250	1
●	B-488	<b>F A</b>	19.05	22.86	–	THT-140-488-3	BBP12, i7100, i5100	R4300, R7950	3000	2
●	B-488	<b>F A</b>	19.05	22.86	–	THT-140-488-1.5-SC	BBP12	R7950	1500	2
⊙	B-488	<b>F A</b>	19.05	–	6.40	M21-750-488	M210-LAB, M211	R4300	1	–
▲	B-492	<b>F N H L</b>	20.96	9.53	–	M6-130-492	M610, M611	R4300, R6400	500	1
▲	B-481	<b>F H</b>	22.86	9.53	–	B33-195-481	i3300	B30 Monocolour	3000	1
▲	B-481	<b>F H</b>	22.86	9.53	–	M5-195-481	M511, BMP51	R6400	320	–
▲	B-481	<b>F H</b>	22.86	9.53	–	M6-195-481	M610, M611	R6400	500	1
▲	B-481	<b>F H</b>	22.86	9.53	–	THT-195-481-3	BBP12, i7100, i5100	R6400	3000	1
●	B-488	<b>F A</b>	22.86	19.05	–	B33-616-488	i3300	B30-R4300	3000	3
▲	B-481	<b>F H</b>	22.86	19.05	–	B33-194-481	i3300	B30 Monocolour	2000	1
●	B-488	<b>F A</b>	22.86	19.05	–	BPT-616-488	BBP12	R7950	3000	3
▲	B-481	<b>F H</b>	22.86	19.05	–	M5-194-481	M511, BMP51	R6400	320	–
▲	B-481	<b>F H</b>	22.86	19.05	–	M6-194-481	M610, M611	R6400	250	1
▲	B-481	<b>F H</b>	22.86	19.05	–	THT-194-481-3	BBP12, i7100, i5100	R6400	3000	1
●	B-488	<b>F A</b>	22.86	22.86	–	B33-617-488	i3300	B30-R4300	3000	3
●	B-488	<b>F A</b>	22.86	22.86	–	BPT-617-488	BBP12	R7950	3000	3
●	B-481	<b>F H</b>	22.86	22.86	–	BPT-207-481	BBP12	R6400	2500	4
▲	B-481	<b>F H</b>	22.86	22.86	–	BPT-164-481	BBP12	R6400	2500	1
▲	B-488	<b>F A</b>	22.86	22.86	–	M5-97-488	M511, BMP51	R4300	280	–
▲	B-481	<b>F H</b>	22.86	22.86	–	M5-97-481	M511, BMP51	R6400	280	–
▲	B-488	<b>F A</b>	22.86	22.86	–	M6-97-488	M610, M611	R4300	250	1
▲	B-481	<b>F H</b>	22.86	22.86	–	M6-97-481	M610, M611	R6400	250	1
▲	B-488	<b>F A</b>	22.86	22.86	–	M7-97-488	M710	R4300, R6200	250	1
▲	B-481	<b>F H</b>	22.86	22.86	–	M7-97-481	M710	R6400	250	1
▲	B-488	<b>F A</b>	22.86	22.86	–	THT-164-488-1	BBP12, i7100, i5100	R4300, R7950	1000	1
▲	B-481	<b>F H</b>	22.86	22.86	–	THT-164-481-3	BBP12, i7100, i5100	R6400	3000	1
●	B-488	<b>F A</b>	22.86	22.86	–	THT-141-488-3	BBP12, i7100, i5100	R4300, R7950	3000	2
●	B-481	<b>F H</b>	22.86	22.86	–	THT-141-481-3	BBP12, i7100, i5100	R6400	3000	2
●	B-481	<b>F H</b>	22.86	22.86	–	THT-141-481-1.5-SC	BBP12	R6400	1500	2
▲	B-492	<b>F N H L</b>	22.86	25.40	–	M6-156-492	M610, M611	R4300, R6400	250	1
▲	B-7425J	<b>F N A H</b>	25.40	12.70	–	J-59-7425J	J7300		1	1

>>

# Slide Labels

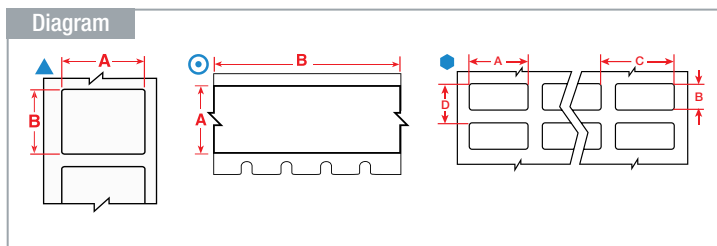

Labels are shown in order of label width.

The background colours in the Order Reference column represent the material colour.

See page 54 for Brady's range of label printers.

Diagram	Material	Special Properties	Label Width A (mm)	Label Height B (mm)	Label Length B (m)	Order Reference	Printer Compatibility	Printer Ribbon Series	Labels per Roll	Labels per Row
▲	B-494	<b>F N H</b>	25.40	12.70	–	M6-17-494-BL	M611, M610	R6400	500	1
▲	B-494	<b>F N H</b>	25.40	12.70	–	M6-17-494-GN	M611, M610	R6400	500	1
▲	B-494	<b>F N H</b>	25.40	12.70	–	M6-17-494-OR	M611, M610	R6400	500	1
▲	B-494	<b>F N H</b>	25.40	12.70	–	M6-17-494-PK	M611, M610	R6400	500	1
▲	B-494	<b>F N H</b>	25.40	12.70	–	M6-17-494-RD	M611, M610	R6400	500	1
▲	B-494	<b>F N H</b>	25.40	12.70	–	M6-17-494-YL	M611, M610	R6400	500	1
▲	B-492	<b>F N H L</b>	25.40	12.70	–	M6-17-492	M610, M611	R4300, R6400	500	1
▲	B-7425J	<b>F N A H</b>	25.40	25.40	–	J-179-7425J	J7300		1	1
▲	B-494	<b>F N H</b>	25.40	25.40	–	M6-19-494-BL	M611, M610	R6400	250	1
▲	B-494	<b>F N H</b>	25.40	25.40	–	M6-19-494-GN	M611, M610	R6400	250	1
▲	B-494	<b>F N H</b>	25.40	25.40	–	M6-19-494-OR	M611, M610	R6400	250	1
▲	B-494	<b>F N H</b>	25.40	25.40	–	M6-19-494-PK	M611, M610	R6400	250	1
▲	B-494	<b>F N H</b>	25.40	25.40	–	M6-19-494-RD	M611, M610	R6400	250	1
▲	B-494	<b>F N H</b>	25.40	25.40	–	M6-19-494-YL	M611, M610	R6400	250	1
▲	B-492	<b>F N H L</b>	25.40	25.40	–	M6-19-492	M610, M611	R4300, R6400	250	1
▲	B-492	<b>F N H L</b>	25.40	44.45	–	M6-203-492	M610, M611	R4300, R6400	250	1
▲	B-492	<b>F N H L</b>	25.40	48.26	–	M6-204-492	M610, M611	R4300, R6400	250	1
⊙	B-7425	<b>F N A H</b>	25.40	–	7.62	M4C-1000-7425	M410, M510, M511	R4300	1	–
⊙	B-7425	<b>F N A H</b>	38.10	–	7.62	M5C-1500-7425	M510, M511	R4300	1	–
▲	B-488	<b>F A</b>	48.26	6.35	–	B33-635-488	i3300	B30-R4300	2000	1
▲	B-488	<b>F A</b>	48.26	6.35	–	M4-81-488	M511, BMP51, BMP41	R4300	160	–
▲	B-488	<b>F A</b>	50.80	6.35	–	THT-15-488-2.5	BBP12, i7100, i5100	R4300, R7950	2500	1
▲	B-481	<b>F H</b>	63.50	5.08	–	THT-142-481-2.5	BBP12, i7100, i5100	R6400	2500	1
▲	B-481	<b>F H</b>	63.50	5.08	–	THT-142-481-2.5-SC	BBP12	R6400	2500	1

**F** Freezer environment    **N** Liquid nitrogen environment    **A** Autoclave environment    **H** Hot water bath (100°C)    **S** Self-laminating label    **L** Low-profile (extremely thin) label    **R** Removable

## UHF RFID label for use on medical slides.



- The RFID label is designed for use on medical slides in the laboratory environment.
- Polyester tag face material, with chip bonded to aluminium antenna using anisotropic conductive film adhesive, suitable for thermal transfer printing, including RFID encoding.

Diagram	Material	Label Width A (mm)	Label Height B (mm)	Order Reference	Printer Compatibility	Printer Ribbon Series	Labels per Roll	Labels per Row
▲	L-2899-4C	24.00	16.00	THT-UHF-481-24x16	Sato CL4NX Plus, Sato CT4LX	R6400	500	1

# Straw and Rod Labels



## Straw and Rod Labels

Brady offers a range of labels designed to fit the small surface area of straws and rods and will withstand long-term storage.

- F** Freezer environment
- N** Liquid nitrogen environment
- A** Autoclave environment
- H** Hot water bath (100°C)
- S** Self-laminating label
- L** Low-profile (extremely thin) label
- R** Removable

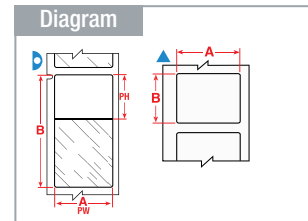

The background colours in the Order Reference column represent the material colour.

See page 54 for Brady's range of label printers.

Labels are shown per straw size and in order of label width.

Diagram	Material	Special Properties	Label Width A (mm)	Label Height B (mm)	Printable Area Width PW (mm)	Printable Area Height PH (mm)	Order Reference	Printer Compatibility	Printer Ribbon Series	Labels per Roll	Labels per Row
<b>0.25 ml</b>											
▲	B-427	<b>FN S</b>	20.00	20.00	-	-	BPTLAB-35-427-YL	BBP12	R7950	1000	1
▷	B-427	<b>FN S</b>	25.40	25.40	25.40	9.53	B33-116-427	i3300	B30 Monocolour	2500	2
▷	B-427	<b>FN S</b>	25.40	25.40	25.40	9.53	BM-19-427	M610, M611, M710	R4300	2500	1
▷	B-427	<b>FN S</b>	25.40	25.40	25.40	9.53	M4-49-427	M511, BMP41, BMP51	R4300	260	-
▷	B-427	<b>FN S</b>	25.40	25.40	25.40	9.53	M6-19-427	M610, M611	R4300	250	1
▷	B-427	<b>FN S</b>	25.40	25.40	25.40	9.53	M6-19-427-BL	M610, M611	R4300, R6700	250	1
▷	B-427	<b>FN S</b>	25.40	25.40	25.40	9.53	M6-19-427-BR	M610, M611	R4300, R6700	250	1
▷	B-427	<b>FN S</b>	25.40	25.40	25.40	9.53	M6-19-427-GR	M610, M611	R4300, R6700	250	1
▷	B-427	<b>FN S</b>	25.40	25.40	25.40	9.53	M6-19-427-GY	M610, M611	R4300, R6700	250	1
▷	B-427	<b>FN S</b>	25.40	25.40	25.40	9.53	M6-19-427-OR	M610, M611	R4300, R6700	250	1
▷	B-427	<b>FN S</b>	25.40	25.40	25.40	9.53	M6-19-427-PL	M610, M611	R4300, R6700	250	1
▷	B-427	<b>FN S</b>	25.40	25.40	25.40	9.53	M6-19-427-RD	M610, M611	R4300, R6700	250	1
▷	B-427	<b>FN S</b>	25.40	25.40	25.40	9.53	M6-19-427-YL	M610, M611	R4300, R6700	250	1
▷	B-461	<b>FNAHSL</b>	25.40	25.40	25.40	9.53	M7-19-461	M710	R4300	250	1
▷	B-427	<b>FN S</b>	25.40	25.40	25.40	9.53	M7-19-427	M710	R4300	250	1
▷	B-427	<b>FN S</b>	25.40	25.40	25.40	9.53	M7-19-427-YL	M710	R4300, R4400, R6700	250	1
▷	B-427	<b>FN S</b>	25.40	25.40	25.40	9.53	THT-116-427-5	BBP12, i7100, i5100	R4300, R7950	5000	2
▷	B-427	<b>FN S</b>	25.40	25.40	25.40	9.65	B33-211-427	i3300	B30-R4300	3000	3
▷	B-427	<b>FN S</b>	25.40	25.40	25.40	9.65	BPT-211-427	BBP12	R7950	3000	3
▷	B-427	<b>FN S</b>	44.45	25.40	38.10	9.53	M5-133-427	M511, BMP51	R4300	140	-
▷	B-427	<b>FN S</b>	44.45	25.40	44.45	9.53	B33-120-427	i3300	B30 Monocolour	1250	1
▷	B-427	<b>FN S</b>	44.45	38.10	44.45	12.70	B33-121-427	i3300	B30 Monocolour	1000	1
▷	B-427	<b>FN S</b>	44.45	38.10	44.45	12.70	M7-88-427	M710	R4300	250	1
<b>0.5 ml</b>											
▷	B-427	<b>FN S</b>	25.40	63.50	25.40	19.05	M4-51-427	M511, BMP51, BMP41	R4300	110	-
▷	B-427	<b>FN S</b>	25.40	63.50	25.40	19.05	B33-511-427	i3300	B30-R4300	1500	3
▷	B-427	<b>FN S</b>	25.40	63.50	25.40	19.05	BM-21-427	M610, M611, M710	R4300	1000	1
▷	B-427	<b>FN S</b>	25.40	63.50	25.40	19.05	BPT-511-427	BBP12	R7950	3000	3
▷	B-427	<b>FN S</b>	25.40	63.50	25.40	19.05	M6-21-427	M611, M610, M710	R4300	100	1
▷	B-427	<b>FN S</b>	25.40	63.50	25.40	19.05	M6-21-427-BL	M610, M611	R4300, R6700	100	1
▷	B-427	<b>FN S</b>	25.40	63.50	25.40	19.05	M6-21-427-BR	M610, M611	R4300, R6700	100	1
▷	B-427	<b>FN S</b>	25.40	63.50	25.40	19.05	M6-21-427-GR	M610, M611	R4300, R6700	100	1
▷	B-427	<b>FN S</b>	25.40	63.50	25.40	19.05	M6-21-427-GY	M610, M611	R4300, R6700	100	1
▷	B-427	<b>FN S</b>	25.40	63.50	25.40	19.05	M6-21-427-OR	M610, M611	R4300, R6700	100	1
▷	B-427	<b>FN S</b>	25.40	63.50	25.40	19.05	M6-21-427-PL	M610, M611	R4300, R6700	100	1
▷	B-427	<b>FN S</b>	25.40	63.50	25.40	19.05	M6-21-427-RD	M610, M611	R4300, R6700	100	1
▷	B-427	<b>FN S</b>	25.40	63.50	25.40	19.05	M6-21-427-YL	M610, M611	R4300, R6700	100	1
▷	B-427	<b>FN S</b>	25.40	63.50	25.40	19.05	M7-21-427	M710	R4300	100	1
▷	B-427	<b>FN S</b>	25.40	63.50	25.40	19.05	M7-21-427-YL	M710	R4300, R4400, R6700	100	1
▷	B-427	<b>FN S</b>	44.45	38.10	44.45	12.70	M5-134-427	M511, BMP51	R4300	140	-
<b>Straw Rod</b>											
▲	B-427	<b>FN</b>	6.35	27.94	6.35	27.94	M4-135-427-AW**	M511, BMP41, BMP51	R4300	240	-
▲	B-427	<b>FN</b>	27.94	6.35	-	-	M6-105-427-AW**	M610, M611	R4300	750	1

\*\*AW = All White / no transparent area.



# Well Plate Labels

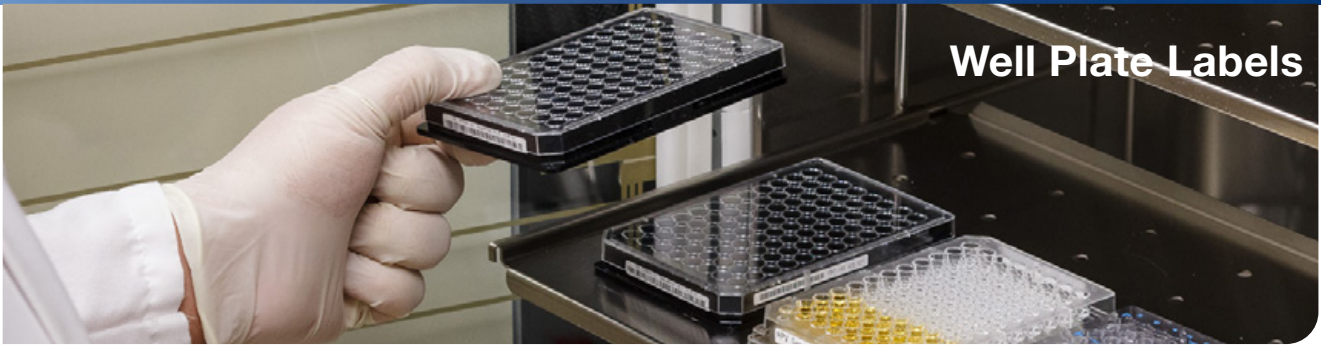

Diagram

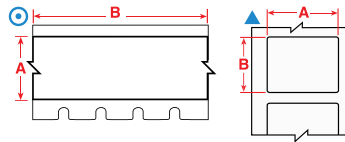

- F** Freezer environment
- N** Liquid nitrogen environment
- A** Autoclave environment
- H** Hot water bath (100°C)
- S** Self-laminating label
- L** Low-profile (extremely thin) label
- R** Removable

## Well Plate Labels

When total tracking of all sample collections is required then Brady has a solution for Well plate identification. Our well plate labels guarantee crystal clear text and barcoding for most lab environments.

Labels are shown in order of label width.

The background colours in the Order Reference column represent the material colour.

See page 54 for Brady's range of label printers.

Diagram	Material	Special Properties	Label Width A (mm)	Label Height B (mm)	Label Length B (m)	Order Reference	Printer Compatibility	Printer Ribbon Series	Labels per Roll	Labels per Row
▲	B-7425	<b>F N A H</b>	6.35	50.80	–	M6-2-7425	M610, M611	R4300, R6400	100	1
○	B-595	<b>F</b>	6.35	–	6.40	M21-250-595-WT	M210, M210-LAB, M211	R6000HF	1	–
○	B-595	<b>F</b>	6.35	–	6.40	M21-250-595-YL	M210, M210-LAB, M211	R6000HF	1	–
○	B-423	<b>F A H</b>	6.35	–	6.40	M21-250-423	M210, M210-LAB, M211	R6200	1	–
○	B-499	<b>F N A</b>	9.53	–	4.88	M21-375-499	M210, M210-LAB, M211	R4300	1	–
○	B-499	<b>F N A</b>	9.53	–	4.88	M4C-375-499	M511, BMP41, BMP51	R4300	1	–
○	B-423	<b>F A H</b>	9.53	–	6.40	M21-375-423	M210, M210-LAB, M211	R6200	1	–
○	B-488	<b>F A</b>	9.53	–	6.40	M21-375-488	M210, M210-LAB, M211	R4300	1	–
○	B-7425	<b>F N A H</b>	9.53	–	6.40	M21-375-7425	M210, M210-LAB, M211	R4300	1	–
○	B-595	<b>F</b>	9.53	–	6.40	M21-375-595-PL	M210, M210-LAB, M211	R4400	1	–
○	B-595	<b>F</b>	9.53	–	6.40	M21-375-595-BR	M210, M210-LAB, M211	R4400	1	–
○	B-595	<b>F</b>	9.53	–	6.40	M21-375-595-GY	M210, M210-LAB, M211	R6000HF	1	–
○	B-595	<b>F</b>	9.53	–	6.40	M21-375-595-BK	M210, M210-LAB, M211	R4400	1	–
○	B-595	<b>F</b>	9.53	–	6.40	M21-375-595-WT	M210, M210-LAB, M211	R6000HF	1	–
○	B-595	<b>F</b>	9.53	–	6.40	M21-375-595-GN	M210, M210-LAB, M211	R4400	1	–
○	B-595	<b>F</b>	9.53	–	6.40	M21-375-595-YL	M210, M210-LAB, M211	R6000HF	1	–
○	B-595	<b>F</b>	9.53	–	6.40	M21-375-595-BL	M210, M210-LAB, M211	R4400	1	–
○	B-595	<b>F</b>	9.53	–	6.40	M21-375-595-OR	M210, M210-LAB, M211	R6000HF	1	–
○	B-595	<b>F</b>	9.53	–	6.40	M21-375-595-RD	M210, M210-LAB, M211	R4400	1	–
○	B-595	<b>F</b>	9.53	–	7.62	M4C-375-595-WT-BK	M511, BMP41, BMP51	R6000HF	1	–
○	B-595	<b>F</b>	9.53	–	7.62	M4C-375-595-YL-BK	M511, BMP41, BMP51	R6000HF	1	–
○	B-595	<b>F</b>	9.53	–	7.62	M4C-375-595-RD-WT	M511, BMP41, BMP51	R4400	1	–
▲	B-423	<b>F A H</b>	12.70	12.70	–	M7-7-423	M710	R6000HF	500	1
▲	B-423	<b>F A</b>	12.70	12.70	–	M6-7-423	M610, M611	R6000HF, R6200, R4400	500	1
▲	B-423	<b>F A H</b>	12.70	12.70	–	BM-7-423	M610, M611, M710	R6000HF, R6200	5000	1
▲	B-499	<b>F N A</b>	12.70	38.10	–	M7-29-499	M710	R4300, R6000HF, R6200	500	1
▲	B-499	<b>F N A</b>	12.70	38.10	–	M6-29-499	M610, M611	R4300, R6200	500	1
○	B-499	<b>F N A</b>	12.70	–	4.88	M21-500-499	M210, M210-LAB, M211	R4300	1	–
○	B-499	<b>F N A</b>	12.70	–	4.88	M4C-500-499	M511, BMP41, BMP51	R4300	1	–
○	B-595	<b>F</b>	12.70	–	6.10	M4C-500-595-CL-BK	M511, BMP41, BMP51	R6000HF	1	–
○	B-595	<b>F</b>	12.70	–	6.10	M4C-500-595-CL-WT	M511, BMP41, BMP51	R4400	1	–
○	B-423	<b>F A H</b>	12.70	–	6.40	M21-500-423	M210, M210-LAB, M211	R6200	1	–
○	B-488	<b>F A</b>	12.70	–	6.40	M21-500-488	M210, M210-LAB, M211	R4300	1	–
○	B-7425	<b>F N A H</b>	12.70	–	6.40	M21-500-7425	M210, M210-LAB, M211	R4300	1	–
○	B-595	<b>F</b>	12.70	–	6.40	M21-500-595-PL	M210, M210-LAB, M211	R4400	1	–
○	B-595	<b>F</b>	12.70	–	6.40	M21-500-595-BR	M210, M210-LAB, M211	R4400	1	–
○	B-595	<b>F</b>	12.70	–	6.40	M21-500-595-GY	M210, M210-LAB, M211	R6000HF	1	–
○	B-595	<b>F</b>	12.70	–	6.40	M21-500-595-BK	M210, M210-LAB, M211	R4400	1	–
○	B-595	<b>F</b>	12.70	–	6.40	M21-500-595-RD	M210, M210-LAB, M211	R4400	1	–
○	B-595	<b>F</b>	12.70	–	6.40	M21-500-595-OR	M210, M210-LAB, M211	R6000HF	1	–
○	B-595	<b>F</b>	12.70	–	6.40	M21-500-595-BL	M210, M210-LAB, M211	R4400	1	–
○	B-595	<b>F</b>	12.70	–	6.40	M21-500-595-YL	M210, M210-LAB, M211	R6000HF	1	–
○	B-595	<b>F</b>	12.70	–	6.40	M21-500-595-GN	M210, M210-LAB, M211	R4400	1	–
○	B-595	<b>F</b>	12.70	–	6.40	M21-500-595-WT	M210, M210-LAB, M211	R6000HF	1	–
○	B-595	<b>F</b>	12.70	–	7.62	M4C-500-595-BL-WT	M511, BMP41, BMP51	R4400	1	–
○	B-595	<b>F</b>	12.70	–	7.62	M4C-500-595-GN-WT	M511, BMP41, BMP51	R4400	1	–
○	B-595	<b>F</b>	12.70	–	7.62	M4C-500-595-OR-BK	M511, BMP41, BMP51	R6000HF	1	–
○	B-595	<b>F</b>	12.70	–	7.62	M4C-500-595-RD-WT	M511, BMP41, BMP51	R4400	1	–
○	B-595	<b>F</b>	12.70	–	7.62	M4C-500-595-WT-BK	M511, BMP41, BMP51	R6000HF	1	–

>>

# Well Plate Labels

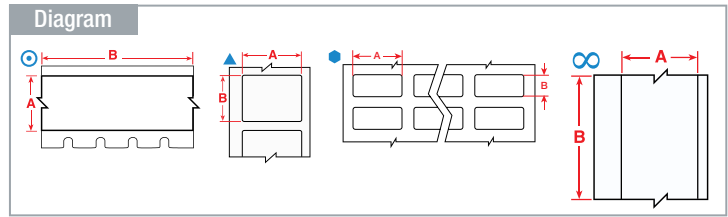
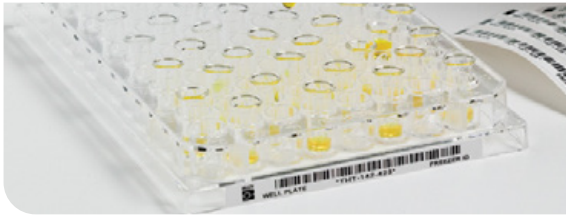

Labels are shown in order of label width.

The background colours in the Order Reference column represent the material colour.

See page 54 for Brady's range of label printers.

Diagram	Material	Special Properties	Label Width A (mm)	Label Height B (mm)	Label Length B (m)	Order Reference	Printer Compatibility	Printer Ribbon Series	Labels per Roll	Labels per Row
⊙	B-595	<b>F</b>	12.70	–	7.62	M4C-500-595-WT-RD	M511, BMP41, BMP51	R4400	1	–
⊙	B-595	<b>F</b>	12.70	–	7.62	M4C-500-595-YL-BK	M511, BMP41, BMP51	R6000HF	1	–
⊙	B-595	<b>F</b>	12.70	–	7.62	M4C-500-595-BK-WT	M511, BMP41, BMP51	R4400	1	–
⊙	B-499	<b>F N A</b>	12.70	–	9.14	M7C-500-499	M710	R4300, R6000HF, R6200	1	1
⊙	B-595	<b>F</b>	12.70	–	15.24	M7C-500-595-YL	M710	R6000HF, R4400-WT	1	1
⊙	B-595	<b>F</b>	12.70	–	15.24	M7C-500-595-WT	M710	R6000HF	1	1
⊙	B-595	<b>F</b>	12.70	–	15.24	M7C-500-595-RD	M710	R6000HF, R4400-WT	1	1
⊙	B-595	<b>F</b>	12.70	–	15.24	M7C-500-595-OR	M710	R6000HF, R4400-WT	1	1
⊙	B-595	<b>F</b>	12.70	–	15.24	M7C-500-595-GN	M710	R6000HF, R4400-WT	1	1
⊙	B-595	<b>F</b>	12.70	–	15.24	M7C-500-595-CL	M710	R6000HF, R4400-WT	1	1
⊙	B-595	<b>F</b>	12.70	–	15.24	M7C-500-595-BL	M710	R6000HF, R4400-WT	1	1
⊙	B-595	<b>F</b>	12.70	–	15.24	M7C-500-595-BK	M710	R4400-WT	1	1
∞	B-595	<b>F</b>	12.70	–	30.48	B30C-500-595-BK	i3300	B30-R10000-WT	1	1
∞	B-595	<b>F</b>	12.70	–	30.48	B30C-500-595-BL	i3300	B30-R10000-WT	1	1
∞	B-595	<b>F</b>	12.70	–	30.48	B30C-500-595-CL	i3300	B30-R10000	1	1
∞	B-595	<b>F</b>	12.70	–	30.48	B30C-500-595-GN	i3300	B30-R10000-WT	1	1
∞	B-595	<b>F</b>	12.70	–	30.48	B30C-500-595-OR	i3300	B30-R10000	1	1
∞	B-595	<b>F</b>	12.70	–	30.48	B30C-500-595-RD	i3300	B30-R10000-WT	1	1
∞	B-595	<b>F</b>	12.70	–	30.48	B30C-500-595-WT	i3300	B30-R10000	1	1
∞	B-595	<b>F</b>	12.70	–	30.48	B30C-500-595-YL	i3300	B30-R10000	1	1
●	B-499	<b>F N A</b>	19.05	6.35	–	B33-1-499	i3300, i5300	B30 Monocolour	10000	4
▲	B-499	<b>F N A</b>	19.05	12.70	–	M21-11-499	M210, M210-LAB, M211	R4300	1	1
▲	B-423	<b>F A H</b>	19.05	12.70	–	M21-7-423	M210, M210-LAB, M211	R6000HF	1	1
●	B-499	<b>F N A</b>	19.05	23.80	–	B33-91-499	i3300, i5300	B30 Monocolour	2500	4
⊙	B-499	<b>F N A</b>	19.05	–	4.88	M21-750-499	M210, M210-LAB, M211	R4300	1	–
⊙	B-499	<b>F N A</b>	19.05	–	4.88	M4C-750-499	M511, BMP41, BMP51	R4300	1	–
⊙	B-595	<b>F</b>	19.05	–	6.10	M4C-750-595-CL-BK	M511, BMP41, BMP51	R6000HF	1	–
⊙	B-595	<b>F</b>	19.05	–	6.10	M4C-750-595-CL-WT	M511, BMP41, BMP51	R4400	1	–
⊙	B-423	<b>F A H</b>	19.05	–	6.40	M21-750-423	M210, M210-LAB, M211	R6200	1	–
⊙	B-488	<b>F A</b>	19.05	–	6.40	M21-750-488	M210, M210-LAB, M211	R4300	1	–
⊙	B-7425	<b>F N A H</b>	19.05	–	6.40	M21-750-7425	M210, M210-LAB, M211	R4300	1	–
⊙	B-595	<b>F</b>	19.05	–	6.40	M21-750-595-PL	M210, M210-LAB, M211	R4400	1	–
⊙	B-595	<b>F</b>	19.05	–	6.40	M21-750-595-BR	M210, M210-LAB, M211	R4400	1	–
⊙	B-595	<b>F</b>	19.05	–	6.40	M21-750-595-GY	M210, M210-LAB, M211	R6000HF	1	–
⊙	B-595	<b>F</b>	19.05	–	6.40	M21-750-595-BK	M210, M210-LAB, M211	R4400	1	–
⊙	B-595	<b>F</b>	19.05	–	6.40	M21-750-595-BL	M210, M210-LAB, M211	R4400	1	–
⊙	B-595	<b>F</b>	19.05	–	6.40	M21-750-595-WT	M210, M210-LAB, M211	R6000HF	1	–
⊙	B-595	<b>F</b>	19.05	–	6.40	M21-750-595-RD	M210, M210-LAB, M211	R4400	1	–
⊙	B-595	<b>F</b>	19.05	–	6.40	M21-750-595-OR	M210, M210-LAB, M211	R6000HF	1	–
⊙	B-595	<b>F</b>	19.05	–	6.40	M21-750-595-GN	M210, M210-LAB, M211	R4400	1	–
⊙	B-595	<b>F</b>	19.05	–	6.40	M21-750-595-YL	M210, M210-LAB, M211	R6000HF	1	–
⊙	B-595	<b>F</b>	19.05	–	7.62	M4C-750-595-BK-WT	M511, BMP41, BMP51	R4400	1	–
⊙	B-595	<b>F</b>	19.05	–	7.62	M4C-750-595-BL-WT	M511, BMP41, BMP51	R4400	1	–
⊙	B-595	<b>F</b>	19.05	–	7.62	M4C-750-595-GN-WT	M511, BMP41, BMP51	R4400	1	–
⊙	B-595	<b>F</b>	19.05	–	7.62	M4C-750-595-OR-BK	M511, BMP41, BMP51	R6000HF	1	–
⊙	B-595	<b>F</b>	19.05	–	7.62	M4C-750-595-RD-WT	M511, BMP41, BMP51	R4400	1	–
⊙	B-595	<b>F</b>	19.05	–	7.62	M4C-750-595-WT-BK	M511, BMP41, BMP51	R6000HF	1	–
⊙	B-595	<b>F</b>	19.05	–	7.62	M4C-750-595-WT-RD	M511, BMP41, BMP51	R4400	1	–
⊙	B-595	<b>F</b>	19.05	–	7.62	M4C-750-595-YL-BK	M511, BMP41, BMP51	R6000HF	1	–
▲	B-499	<b>F N A</b>	22.86	12.70	–	M7-84-499	M710	R4300, R6000HF, R6200	500	1
●	B-488	<b>F A</b>	22.86	19.05	–	B33-616-488	i3300	B30-R4300	3000	3
●	B-488	<b>F A</b>	22.86	22.86	–	B33-617-488	i3300	B30-R4300	3000	3
▲	B-423	<b>F A H</b>	25.40	4.75	–	M7-14-423	M710	R6000HF	750	1
▲	B-423	<b>F A</b>	25.40	4.75	–	M6-14-423	M610, M611	R6000HF, R6200, R4400	750	1
●	B-423	<b>F A H</b>	25.40	4.75	–	THT-41-423-10	BBP12, i7100, i5100	R6000HF	10000	3
●	B-423	<b>F A H</b>	25.40	6.35	–	THT-51-423-10	BBP12, i7100, i5100	R6000HF	10000	3

>>

**F** Freezer environment    **N** Liquid nitrogen environment    **A** Autoclave environment    **H** Hot water bath (100°C)    **S** Self-laminating label    **L** Low-profile (extremely thin) label    **R** Removable

# Well Plate Labels

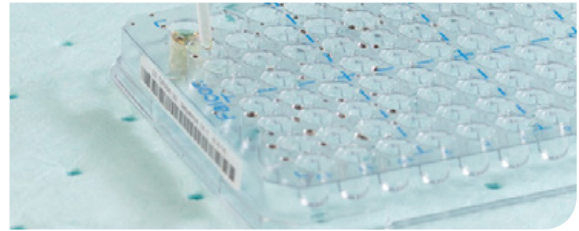
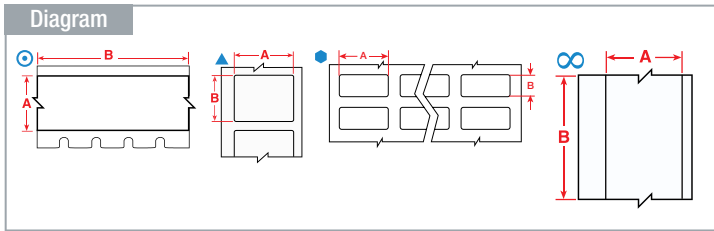

Labels are shown in order of label width.

The background colours in the Order Reference column represent the material colour.

See page 54 for Brady's range of label printers.

Diagram	Material	Special Properties	Label Width A (mm)	Label Height B (mm)	Label Length B (m)	Order Reference	Printer Compatibility	Printer Ribbon Series	Labels per Roll	Labels per Row
▲	B-423	<b>F</b> <b>A</b> <b>H</b>	25.40	6.99	–	M7-15-423	M710	R6000HF	750	1
▲	B-423	<b>F</b> <b>A</b>	25.40	6.99	–	M6-15-423	M610, M611	R6000HF, R6200, R4400	750	1
●	B-499	<b>F</b> <b>N</b> <b>A</b>	25.40	9.53	–	THT-152-499-1.5-SC	BBP12	R7950, R4300, R4900	1500	2
●	B-499	<b>F</b> <b>N</b> <b>A</b>	25.40	9.53	–	B33-152-499	i3300	B30 Monocolour	1500	2
●	B-499	<b>F</b> <b>N</b> <b>A</b>	25.40	9.53	–	THT-152-499-3	BBP12, i7100, i5100	R4900	3000	2
▲	B-499	<b>F</b> <b>N</b> <b>A</b>	25.40	12.70	–	M21-131-499	M210, M210-LAB, M211	R4300	1	1
▲	B-423	<b>F</b> <b>A</b> <b>H</b>	25.40	12.70	–	M21-17-423	M210, M210-LAB, M211	R6000HF	1	1
●	B-499	<b>F</b> <b>N</b> <b>A</b>	25.40	12.70	–	B33-5-499	i3300, i5300	B30 Monocolour	5000	3
▲	B-423	<b>F</b> <b>A</b> <b>H</b>	25.40	12.70	–	M7-17-423	M710	R6000HF	500	1
▲	B-423	<b>F</b> <b>A</b>	25.40	12.70	–	M6-17-423	M610, M611	R6000HF, R6200, R4400	500	1
▲	B-7425J	<b>F</b> <b>N</b> <b>A</b> <b>H</b>	25.40	12.70	–	J-59-7425J	J7300		1	1
▲	B-499	<b>F</b> <b>N</b> <b>A</b>	25.40	19.05	–	M21-18-499	M210, M210-LAB, M211	R4300	1	1
▲	B-423	<b>F</b> <b>A</b> <b>H</b>	25.40	19.05	–	M21-18-423	M210, M210-LAB, M211	R6000HF	1	1
●	B-499	<b>F</b> <b>N</b> <b>A</b>	25.40	19.05	–	B33-88-499	i3300, i5300	B30 Monocolour	2500	2
▲	B-490	<b>F</b> <b>N</b> <b>H</b> <b>L</b>	25.40	44.45	–	M6-203-490	M610, M611	R4300	250	1
▲	B-423	<b>F</b> <b>A</b> <b>H</b>	25.40	50.80	–	M7-20-423	M710	R6000HF	100	1
▲	B-423	<b>F</b> <b>A</b> <b>H</b>	25.40	50.80	–	BM-20-423	M610, M611, M710	R6000HF	1000	1
▲	B-423	<b>F</b> <b>A</b>	25.40	50.80	–	M6-20-423	M610, M611	R6000HF, R6200, R4400	100	1
▲	B-499	<b>F</b> <b>N</b> <b>A</b>	25.40	76.20	–	M4-22-499	M410, M510, M511	R4300	100	1
○	B-499	<b>F</b> <b>N</b> <b>A</b>	25.40	–	4.88	M5C-1000-499	M511, BMP51	R4300	1	–
○	B-595	<b>F</b>	25.40	–	6.10	M4C-1000-595-CL-BK	M511, BMP41, BMP51	R6000HF	1	–
○	B-595	<b>F</b>	25.40	–	6.10	M4C-1000-595-CL-WT	M511, BMP41, BMP51	R4400	1	–
○	B-595	<b>F</b>	25.40	–	7.62	M4C-1000-595-WT-BK	M511, BMP41, BMP51	R6000HF	1	–
○	B-595	<b>F</b>	25.40	–	7.62	M4C-1000-595-YL-BK	M511, BMP41, BMP51	R6000HF	1	–
○	B-595	<b>F</b>	25.40	–	7.62	M4C-1000-595-OR-BK	M511, BMP41, BMP51	R6000HF	1	–
○	B-595	<b>F</b>	25.40	–	7.62	M4C-1000-595-BL-WT	M511, BMP41, BMP51	R4400	1	–
○	B-595	<b>F</b>	25.40	–	7.62	M4C-1000-595-RD-WT	M511, BMP41, BMP51	R4400	1	–
○	B-595	<b>F</b>	25.40	–	7.62	M4C-1000-595-GN-WT	M511, BMP41, BMP51	R4400	1	–
○	B-595	<b>F</b>	25.40	–	7.62	M4C-1000-595-WT-RD	M511, BMP41, BMP51	R4400	1	–
○	B-595	<b>F</b>	25.40	–	7.62	M4C-1000-595-BK-WT	M511, BMP41, BMP51	R4400	1	–
○	B-423	<b>F</b> <b>A</b> <b>H</b>	25.40	–	7.62	M4C-1000-423	M410, M510, M511	R6200	1	–
○	B-7425	<b>F</b> <b>N</b> <b>A</b> <b>H</b>	25.40	–	7.62	M4C-1000-7425	M410, M510, M511	R4300	1	–
○	B-499	<b>F</b> <b>N</b> <b>A</b>	25.40	–	9.14	M7C-1000-499	M710	R4300, R6000HF, R6200	1	1
○	B-595	<b>F</b>	25.40	–	15.24	M7C-1000-595-YL	M710	R6000HF, R4400-WT	1	1
○	B-595	<b>F</b>	25.40	–	15.24	M7C-1000-595-WT	M710	R6000HF	1	1
○	B-595	<b>F</b>	25.40	–	15.24	M7C-1000-595-RD	M710	R6000HF, R4400-WT	1	1
○	B-595	<b>F</b>	25.40	–	15.24	M7C-1000-595-OR	M710	R6000HF, R4400-WT	1	1
○	B-595	<b>F</b>	25.40	–	15.24	M7C-1000-595-GN	M710	R6000HF, R4400-WT	1	1
○	B-595	<b>F</b>	25.40	–	15.24	M7C-1000-595-CL	M710	R6000HF, R4400-WT	1	1
○	B-595	<b>F</b>	25.40	–	15.24	M7C-1000-595-BL	M710	R6000HF, R4400-WT	1	1
○	B-595	<b>F</b>	25.40	–	15.24	M7C-1000-595-BK	M710	R4400-WT	1	1
●	B-423	<b>F</b> <b>A</b> <b>H</b>	27.94	9.65	–	THT-31-423-10	BBP12, i7100, i5100	R6000HF	10000	2
●	B-423	<b>F</b> <b>A</b> <b>H</b>	38.10	12.70	–	THT-37-423-10	BBP12, i7100, i5100	R6000HF	10000	2
▲	B-499	<b>F</b> <b>N</b> <b>A</b>	38.10	19.05	–	THT-136-499-1.5-SC	BBP12	R7950, R4300, R4900	1500	1
▲	B-499	<b>F</b> <b>N</b> <b>A</b>	38.10	19.05	–	B33-136-499	i3300	B30 Monocolour	1500	1
▲	B-499	<b>F</b> <b>N</b> <b>A</b>	38.10	19.05	–	M21-136-499	M210, M210-LAB, M211	R4300	1	1
▲	B-423	<b>F</b> <b>A</b> <b>H</b>	38.10	19.05	–	M21-30-423	M210, M210-LAB, M211	R6000HF	1	1
▲	B-499	<b>F</b> <b>N</b> <b>A</b>	38.10	19.05	–	M7-30-499	M710	R4300, R6000HF, R6200	250	1
▲	B-499	<b>F</b> <b>N</b> <b>A</b>	38.10	19.05	–	M6-30-499	M610, M611	R4300, R6200	250	1
▲	B-7425J	<b>F</b> <b>N</b> <b>A</b> <b>H</b>	38.10	19.05	–	J-136-7425J	J7300		1	1
▲	B-499	<b>F</b> <b>N</b> <b>A</b>	38.10	19.05	–	THT-136-499-3	BBP12, i7100, i5100	R4900	3000	1
▲	B-499	<b>F</b> <b>N</b> <b>A</b>	38.10	25.40	–	M7-31-499	M710	R4300, R6000HF, R6200	250	1
▲	B-423	<b>F</b> <b>A</b> <b>H</b>	38.10	25.40	–	M7-31-423	M710	R6000HF	250	1
▲	B-423	<b>F</b> <b>A</b>	38.10	25.40	–	M6-31-423	M610, M611	R6000HF, R6200, R4400	250	1
▲	B-499	<b>F</b> <b>N</b> <b>A</b>	38.10	25.40	–	M6-31-499	M610, M611	R4300, R6200	250	1

>>

<b>F</b> Freezer environment	<b>N</b> Liquid nitrogen environment	<b>A</b> Autoclave environment	<b>H</b> Hot water bath (100°C)	<b>S</b> Self-laminating label	<b>L</b> Low-profile (extremely thin) label	<b>R</b> Removable
------------------------------	--------------------------------------	--------------------------------	---------------------------------	--------------------------------	---	--------------------

# Well Plate Labels

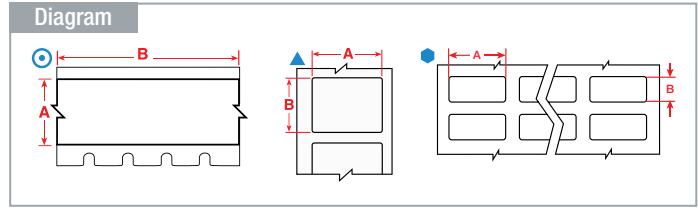

Labels are shown in order of label width.

The background colours in the Order Reference column represent the material colour.

See page 54 for Brady's range of label printers.

Diagram	Material	Special Properties	Label Width A (mm)	Label Height B (mm)	Label Length B (m)	Order Reference	Printer Compatibility	Printer Ribbon Series	Labels per Roll	Labels per Row
▲	B-490	<b>F N H L</b>	38.10	55.88	–	M6-113-490	M610, M611	R4300	100	1
▲	B-490	<b>F N H L</b>	38.10	98.43	–	M6-114-490	M610, M611	R4300	100	1
○	B-7425	<b>F N A H</b>	38.10	–	7.62	M5C-1500-7425	M511, M511	R4300	1	–
▲	B-488	<b>F A</b>	48.26	6.35	–	M4-81-488	M511, BMP51, BMP41	R4300	160	–
▲	B-499	<b>F N A</b>	48.26	6.35	–	M7-81-499	M710	R4300, R6000HF, R6200	750	1
▲	B-488	<b>F A</b>	48.26	6.35	–	M7-81-488	M710	R4300	750	1
▲	B-488	<b>F A</b>	48.26	6.35	–	M6-81-488	M610, M611	R4300	750	1
▲	B-499	<b>F N A</b>	48.26	6.35	–	M6-81-499	M610, M611	R4300, R6200	750	1
▲	B-488	<b>F A</b>	48.26	6.35	–	BPT-635-488	BBP12	R7950	2000	1
▲	B-488	<b>F A</b>	48.26	6.35	–	B33-635-488	i3300	B30-R4300	2000	1
▲	B-499	<b>F N A</b>	48.26	25.40	–	M7-78-499	M710	R4300, R6000HF, R6200	250	1
▲	B-488	<b>F A</b>	48.26	25.40	–	M6-78-488	M610, M611	R4300	250	1
▲	B-499	<b>F N A</b>	48.26	25.40	–	M6-78-499	M610, M611	R4300, R6200	250	1
○	B-499	<b>F N A</b>	48.26	–	9.14	M7C-1900-499	M710	R4300, R6000HF, R6200	1	1
▲	B-499	<b>F N A</b>	50.80	6.35	–	THT-151-499-1.5-SC	BBP12	R7950, R4300, R4900	1500	1
▲	B-499	<b>F N A</b>	50.80	6.35	–	B33-151-499	i3300	B30 Monocolour	1500	1
▲	B-423	<b>F A H</b>	50.80	6.35	–	M7-2-423	M710	R6000HF	100	1
▲	B-423	<b>F A</b>	50.80	6.35	–	M6-2-423	M610, M611	R6000HF, R6200, R4400	100	1
▲	B-423	<b>F A H</b>	50.80	6.35	–	THT-15-423-2.5	BBP12, i7100, i5100	R6000HF	2500	1
▲	B-499	<b>F N A</b>	50.80	6.35	–	THT-151-499-3	BBP12, i7100, i5100	R4900	3000	1
▲	B-7425J		50.80	12.70	–	J-53-7425J	J7300		1	1
▲	B-499	<b>F N A</b>	50.80	19.05	–	M21-137-499	M210, M210-LAB, M211	R4300	1	1
▲	B-423	<b>F A H</b>	50.80	19.05	–	M21-137-423	M210, M210-LAB, M211	R6000HF	1	1
▲	B-423	<b>F A H</b>	63.50	5.08	–	THT-142-423-2.5	BBP12, i7100, i5100	R6000HF	2500	1
▲	B-423	<b>F A H</b>	76.20	25.40	–	M7-22-423	M710	R6000HF	100	1
▲	B-423	<b>F A</b>	76.20	25.40	–	M6-22-423	M610, M611	R6000HF, R6200, R4400	100	1

**F** Freezer environment    **N** Liquid nitrogen environment    **A** Autoclave environment    **H** Hot water bath (100°C)    **S** Self-laminating label    **L** Low-profile (extremely thin) label    **R** Removable

## Track and trace multiple samples throughout your lab with RFID



- Small size that fits medical well plates, Petri dishes and cell culture dishes.
- Extremely chemical resistant B-7425 label material, especially when printed with ribbon R6400.
- An RFID reader brings every labeled item on-screen within a 1 metre radius, enables specific item selection and guides users to it with visuals and sound.

Diagram	Material	Label Width A (mm)	Label Height B (mm)	Order Reference	Printer Compatibility	Printer Ribbon Series	Labels per Roll	Labels per Row
▲	L-2588-35C	65.00	6.00	THT-UHF-B7425-65x6-0.5	Sato CL4NX Plus, Sato CT4LX	R6400	500	1



## Bottles / Flasks & Dishes

Brady's labels for bottles, flasks and dishes are easy to handle and flexible. This enables the labels to be placed on curved containers and remain attached and legible, even after being subjected to freezing, liquid nitrogen and heat.

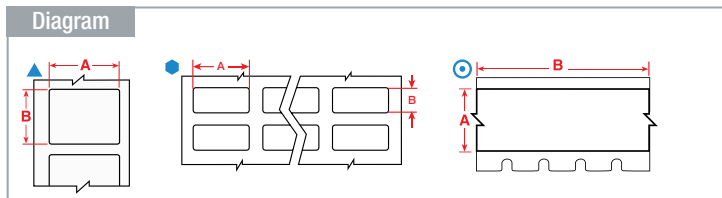

- F** Freezer environment
- N** Liquid nitrogen environment
- A** Autoclave environment
- H** Hot water bath (100°C)
- S** Self-laminating label
- L** Low-profile (extremely thin) label
- R** Removable

Labels are shown in order of label width.

The background colours in the Order Reference column represent the material colour.

See page 54 for Brady's range of label printers.

Diagram	Material	Special Properties	Label Width A (mm)	Label Height B (mm)	Label Length B (m)	Printable Area Width PW (mm)	Printable Area Height PH (mm)	Order Reference	Printer Compatibility	Printer Ribbon Series	Labels per Roll	Labels per Row
●	B-499	<b>FNA</b>	6.35	36.50	—	—	—	B33-90-499	i3300, i5300	B30 Monocolour	2500	6
○	B-423	<b>F AH</b>	6.35	—	6.40	—	—	M21-250-423	M210, M210-LAB, M211	R6200	1	—
○	B-499	<b>FNA</b>	9.53	—	4.88	—	—	M4C-375-499	M511, BMP41, BMP51	R4300	1	—
○	B-499	<b>FNA</b>	9.53	—	4.88	—	—	M21-375-499	M210, M210-LAB, M211	R4300	1	—
○	B-461	<b>FNAHSL</b>	9.53	—	15.24	—	—	M6C-375-461	M610, M611	R4300, R6200	1	1
▲	B-423	<b>F AH</b>	12.70	12.70	—	—	—	BM-7-423	M610, M611, M710	R6000HF, R6200	5000	1
▲	B-499	<b>FNA</b>	12.70	12.70	—	—	—	M6-7-499	M610, M611	R4300, R6200	500	1
▲	B-423	<b>F A</b>	12.70	12.70	—	—	—	M6-7-423	M610, M611	R6000HF, R6200, R4400	500	1
▲	B-423	<b>F AH</b>	12.70	12.70	—	—	—	M7-7-423	M710	R6000HF	500	1
●	B-499	<b>FNA</b>	12.70	19.05	—	—	—	B33-68-499	i3300	B30 Monocolour	1500	4
●	B-499	<b>FNA</b>	12.70	19.05	—	—	—	THT-68-499-10	BBP12, i7100, i5100	R4900	10000	4
●	B-499	<b>FNA</b>	12.70	36.50	—	—	—	B33-87-499	i3300, i5300	B30 Monocolour	2500	6
▲	B-499	<b>FNA</b>	12.70	38.10	—	—	—	M6-29-499	M610, M611	R4300, R6200	500	1
▲	B-499	<b>FNA</b>	12.70	38.10	—	—	—	M7-29-499	M710	R4300, R6000HF, R6200	500	1
▲	B-492	<b>FN H L</b>	12.70	41.91	—	—	—	M6-124-492	M610, M611	R4300, R6400	500	1
○	B-499	<b>FNA</b>	12.70	—	4.88	—	—	M4C-500-499	M511, BMP41, BMP51	R4300	1	—
○	B-499	<b>FNA</b>	12.70	—	4.88	—	—	M21-500-499	M210, M210-LAB, M211	R4300	1	—
○	B-499	<b>FNA</b>	12.70	—	9.14	—	—	M7C-500-499	M710	R4300, R6000HF, R6200	1	1
○	B-461	<b>FNAHSL</b>	12.70	—	15.24	—	—	M6C-500-461	M610, M611	R4300, R6200	1	1
●	B-499	<b>FNA</b>	19.05	6.35	—	—	—	B33-1-499	i3300, i5300	B30 Monocolour	10000	4
▲	B-499	<b>FNA</b>	19.05	12.70	—	—	—	M21-11-499	M210, M210-LAB, M211	R4300	1	1
▲	B-423	<b>F AH</b>	19.05	12.70	—	—	—	M21-7-423	M210, M210-LAB, M211	R6000HF	1	1
▲	B-499	<b>FNA</b>	19.05	19.05	—	—	—	B33-254-499	i3300, i5300	B30 Monocolour	1000	1
●	B-488	<b>F A</b>	19.05	22.86	—	—	—	THT-140-488-3	BBP12, i7100, i5100	R4300, R7950	3000	2
●	B-488	<b>F A</b>	19.05	22.86	—	—	—	THT-140-488-1.5-SC	BBP12	R7950	1500	2
●	B-499	<b>FNA</b>	19.05	23.80	—	—	—	B33-91-499	i3300, i5300	B30 Monocolour	2500	4
○	B-499	<b>FNA</b>	19.05	—	4.88	—	—	M4C-750-499	M511, BMP41, BMP51	R4300	1	—
○	B-499	<b>FNA</b>	19.05	—	4.88	—	—	M21-750-499	M210, M210-LAB, M211	R4300	1	—
▲	B-499	<b>FNA</b>	20.96	9.53	—	—	—	M4-130-499	M511, BMP41, BMP51	R4300	220	—
▲	B-492	<b>FN H L</b>	20.96	9.53	—	—	—	M6-130-492	M610, M611	R4300, R6400	500	1
▲	B-499	<b>FNA</b>	22.86	12.70	—	—	—	B33-125-499	i3300	B30 Monocolour	1500	1
▲	B-499	<b>FNA</b>	22.86	12.70	—	—	—	M6-84-499	M610, M611	R4300, R6200	500	1
▲	B-499	<b>FNA</b>	22.86	12.70	—	—	—	THT-125-499-3	BBP12, i7100, i5100	R4900	3000	1
▲	B-499	<b>FNA</b>	22.86	12.70	—	—	—	THT-125-499-1.5-SC	BBP12	R7950, R4300, R4900	1500	1
●	B-488	<b>F A</b>	22.86	19.05	—	—	—	B33-616-488	i3300	B30-R4300	3000	3
●	B-488	<b>F A</b>	22.86	22.86	—	—	—	B33-617-488	i3300	B30-R4300	3000	3
▲	B-488	<b>F A</b>	22.86	22.86	—	—	—	THT-164-488-1-SC	BBP12	R7950	1000	1
●	B-488	<b>F A</b>	22.86	22.86	—	—	—	THT-141-488-3	BBP12, i7100, i5100	R4300, R7950	3000	2
▲	B-492	<b>FN H L</b>	22.86	25.40	—	—	—	M6-156-492	M610, M611	R4300, R6400	250	1
▲	B-423	<b>F A</b>	25.40	4.75	—	—	—	M6-14-423	M610, M611	R6000HF, R6200, R4400	750	1
▲	B-423	<b>F AH</b>	25.40	4.75	—	—	—	M7-14-423	M710	R6000HF	750	1
●	B-423	<b>F AH</b>	25.40	4.75	—	—	—	THT-41-423-10	BBP12, i7100, i5100	R6000HF	10000	3
●	B-423	<b>F AH</b>	25.40	6.35	—	—	—	THT-51-423-10	BBP12, i7100, i5100	R6000HF	10000	3
▲	B-423	<b>F A</b>	25.40	6.99	—	—	—	M6-15-423	M610, M611	R6000HF, R6200, R4400	750	1

>>

# Bottles / Flasks & Dishes

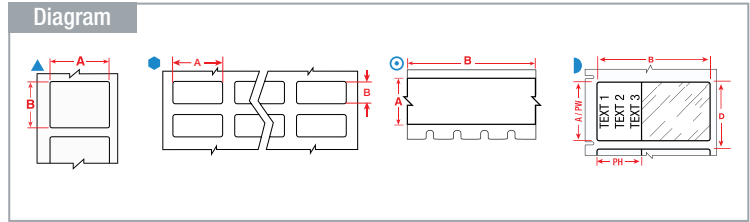

Labels are shown in order of label width.

The background colours in the Order Reference column represent the material colour.

See page 54 for Brady's range of label printers.

Diagram	Material	Special Properties	Label Width A (mm)	Label Height B (mm)	Label Length B (m)	Printable Area Width PW (mm)	Printable Area Height PH (mm)	Order Reference	Printer Compatibility	Printer Ribbon Series	Labels per Roll	Labels per Row
▲	B-423	<b>F AH</b>	25.40	6.99	-	-	-	M7-15-423	M710	R6000HF	750	1
●	B-499	<b>FNA</b>	25.40	9.53	-	-	-	B33-152-499	i3300	B30 Monocolour	1500	2
●	B-499	<b>FNA</b>	25.40	9.53	-	-	-	THT-152-499-3	BBP12, i7100, i5100	R4900	3000	2
●	B-499	<b>FNA</b>	25.40	9.53	-	-	-	THT-152-499-1.5-SC	BBP12	R7950, R4300, R4900	1500	2
▲	B-494	<b>FN H</b>	25.40	12.70	-	25.40	9.53	M6-17-494-BL	M611, M610	R6400	500	1
▲	B-494	<b>FN H</b>	25.40	12.70	-	25.40	9.53	M6-17-494-GN	M611, M610	R6400	500	1
▲	B-494	<b>FN H</b>	25.40	12.70	-	25.40	9.53	M6-17-494-OR	M611, M610	R6400	500	1
▲	B-494	<b>FN H</b>	25.40	12.70	-	25.40	9.53	M6-17-494-PK	M611, M610	R6400	500	1
▲	B-494	<b>FN H</b>	25.40	12.70	-	25.40	9.53	M6-17-494-RD	M611, M610	R6400	500	1
▲	B-494	<b>FN H</b>	25.40	12.70	-	25.40	9.53	M6-17-494-YL	M611, M610	R6400	500	1
●	B-499	<b>FNA</b>	25.40	12.70	-	-	-	B33-5-499	i3300, i5300	B30 Monocolour	5000	3
●	B-423	<b>F AH</b>	25.40	12.70	-	-	-	B33-5-423	i3300	B30 Monocolour	5000	3
▲	B-499	<b>FNA</b>	25.40	12.70	-	-	-	M4-131-499	M511, BMP41, BMP51	R4300	180	-
▲	B-492	<b>FN H L</b>	25.40	12.70	-	-	-	M6-17-492	M610, M611	R4300, R6400	500	1
▲	B-423	<b>F A</b>	25.40	12.70	-	-	-	M6-17-423	M610, M611	R6000HF, R6200, R4400	500	1
▲	B-423	<b>F AH</b>	25.40	12.70	-	-	-	M7-17-423	M710	R6000HF	500	1
▲	B-499	<b>FNA</b>	25.40	12.70	-	-	-	M21-131-499	M210, M210-LAB, M211	R4300	1	1
▲	B-423	<b>F AH</b>	25.40	12.70	-	-	-	M21-17-423	M210, M210-LAB, M211	R6000HF	1	1
●	B-488	<b>F A</b>	25.40	12.70	-	-	-	THT-5-488-10	BBP12, i7100, i5100	R4300, R7950	10000	3
●	B-499	<b>FNA</b>	25.40	19.05	-	-	-	B33-88-499	i3300, i5300	B30 Monocolour	2500	2
▲	B-499	<b>FNA</b>	25.40	19.05	-	-	-	M21-18-499	M210, M210-LAB, M211	R4300	1	1
▲	B-423	<b>F AH</b>	25.40	19.05	-	-	-	M21-18-423	M210, M210-LAB, M211	R6000HF	1	1
●	B-492	<b>FN H L</b>	25.40	19.05	-	-	-	THT-88-492-5	BBP12, i7100, i5100	R6400	5000	2
▲	B-494	<b>FN H</b>	25.40	25.40	-	25.40	22.23	M6-19-494-BL	M611, M610	R6400	250	1
▲	B-494	<b>FN H</b>	25.40	25.40	-	25.40	22.23	M6-19-494-GN	M611, M610	R6400	250	1
▲	B-494	<b>FN H</b>	25.40	25.40	-	25.40	22.23	M6-19-494-OR	M611, M610	R6400	250	1
▲	B-494	<b>FN H</b>	25.40	25.40	-	25.40	22.23	M6-19-494-PK	M611, M610	R6400	250	1
▲	B-494	<b>FN H</b>	25.40	25.40	-	25.40	22.23	M6-19-494-RD	M611, M610	R6400	250	1
▲	B-494	<b>FN H</b>	25.40	25.40	-	25.40	22.23	M6-19-494-YL	M611, M610	R6400	250	1
▲	B-492	<b>FN H L</b>	25.40	25.40	-	-	-	M6-19-492	M610, M611	R4300, R6400	250	1
▲	B-499	<b>FNA</b>	25.40	25.40	-	-	-	M7-19-499	M710	R4300, R6000HF, R6200	250	1
▲	B-492	<b>FN H L</b>	25.40	25.40	-	-	-	M7-19-492	M710	R6400	250	1
●	B-499	<b>FNA</b>	25.40	36.50	-	-	-	B33-89-499	i3300, i5300	B30 Monocolour	2300	3
▲	B-492	<b>FN H L</b>	25.40	44.45	-	-	-	M6-203-492	M610, M611	R4300, R6400	250	1
▲	B-490	<b>FN H L</b>	25.40	44.45	-	-	-	M6-203-490	M610, M611	R4300	250	1
▲	B-492	<b>FN H L</b>	25.40	48.26	-	-	-	M6-204-492	M610, M611	R4300, R6400	250	1
▲	B-423	<b>F AH</b>	25.40	50.80	-	-	-	BM-20-423	M610, M611, M710	R6000HF	1000	1
▲	B-423	<b>F A</b>	25.40	50.80	-	-	-	M6-20-423	M610, M611	R6000HF, R6200, R4400	100	1
▲	B-423	<b>F AH</b>	25.40	50.80	-	-	-	M7-20-423	M710	R6000HF	100	1
●	B-499	<b>FNA</b>	25.40	63.50	-	-	-	B33-325-499	i3300, i5300	B30 Monocolour	700	2
●	B-499	<b>FNA</b>	25.40	101.60	-	-	-	B33-326-499	i3300, i5300	B30 Monocolour	450	2
○	B-499	<b>FNA</b>	25.40	-	4.88	-	-	M5C-1000-499	M511, BMP51	R4300	1	-
○	B-499	<b>FNA</b>	25.40	-	9.14	-	-	M7C-1000-499	M710	R4300, R6000HF, R6200	1	1
▷	B-461	<b>FNAHSL</b>	28.58	9.53	-	19.05	9.53	M6-123-461	M610, M611	R4300, R6200	500	1
▷	B-461	<b>FNAHSL</b>	28.58	12.70	-	19.05	12.70	M6-122-461	M610, M611	R4300, R6200	500	1
▲	B-499	<b>FNA</b>	38.10	19.05	-	-	-	B33-136-499	i3300	B30 Monocolour	1500	1
▲	B-499	<b>FNA</b>	38.10	19.05	-	-	-	M6-30-499	M610, M611	R4300, R6200	250	1
▲	B-499	<b>FNA</b>	38.10	19.05	-	-	-	M7-30-499	M710	R4300, R6000HF, R6200	250	1
▲	B-499	<b>FNA</b>	38.10	19.05	-	-	-	M21-136-499	M210, M210-LAB, M211	R4300	1	1
▲	B-423	<b>F AH</b>	38.10	19.05	-	-	-	M21-30-423	M210, M210-LAB, M211	R6000HF	1	1
▲	B-499	<b>FNA</b>	38.10	19.05	-	-	-	THT-136-499-3	BBP12, i7100, i5100	R4900	3000	1
▲	B-499	<b>FNA</b>	38.10	19.05	-	-	-	THT-136-499-1.5-SC	BBP12	R7950, R4300, R4900	1500	1
▲	B-499	<b>FNA</b>	38.10	25.40	-	-	-	M6-31-499	M610, M611	R4300, R6200	250	1
▲	B-423	<b>F A</b>	38.10	25.40	-	-	-	M6-31-423	M610, M611	R6000HF, R6200, R4400	250	1

>>

**F** Freezer environment    **N** Liquid nitrogen environment    **A** Autoclave environment    **H** Hot water bath (100°C)    **S** Self-laminating label    **L** Low-profile (extremely thin) label    **R** Removable

# Bottles / Flasks & Dishes

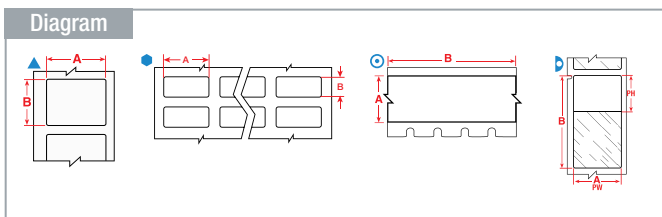

Labels are shown in order of label width.

The background colours in the Order Reference column represent the material colour.

See page 54 for Brady's range of label printers.

Diagram	Material	Special Properties	Label Width A (mm)	Label Height B (mm)	Label Length B (m)	Printable Area Width PW (mm)	Printable Area Height PH (mm)	Order Reference	Printer Compatibility	Printer Ribbon Series	Labels per Roll	Labels per Row
▲	B-499	<b>FNA</b>	38.10	25.40	-	-	-	M7-31-499	M710	R4300, R6000HF, R6200	250	1
▲	B-423	<b>FNAH</b>	38.10	25.40	-	-	-	M7-31-423	M710	R6000HF	250	1
▲	B-499	<b>FNA</b>	38.10	31.75	-	-	-	M5-132-499	M511, BMP51	R4300	160	-
▲	B-490	<b>FNH L</b>	38.10	55.88	-	-	-	M6-113-490	M610, M611	R4300	100	1
▲	B-490	<b>FNH L</b>	38.10	98.43	-	-	-	M6-114-490	M610, M611	R4300	100	1
●	B-499	<b>FNA</b>	38.10	101.60	-	-	-	B33-327-499	i3300, i5300	B30 Monocolour	450	2
●	B-499	<b>FNA</b>	38.10	152.40	-	-	-	B33-328-499	i3300, i5300	B30 Monocolour	300	2
▷	B-461	<b>FNAHSL</b>	41.91	12.70	-	19.05	12.70	M6-202-461	M610, M611	R4300, R6200	500	1
▷	B-461	<b>FNAHSL</b>	44.45	25.40	-	25.40	25.40	M6-203-461	M610, M611	R4300, R6200	100	1
▷	B-461	<b>FNAHSL</b>	45.72	15.24	-	25.40	15.24	M6-201-461	M610, M611	R4300, R6200	100	1
▲	B-488	<b>FA</b>	48.26	6.35	-	-	-	B33-635-488	i3300	B30-R4300	2000	1
▲	B-499	<b>FNA</b>	48.26	25.40	-	-	-	M6-78-499	M610, M611	R4300, R6200	250	1
▲	B-488	<b>FA</b>	48.26	25.40	-	-	-	M6-78-488	M610, M611	R4300	250	1
▲	B-499	<b>FNA</b>	48.26	25.40	-	-	-	M7-78-499	M710	R4300, R6000HF, R6200	250	1
⊙	B-499	<b>FNA</b>	48.26	-	9.14	-	-	M7C-1900-499	M710	R4300, R6000HF, R6200	1	1
▲	B-499	<b>FNA</b>	50.80	6.35	-	-	-	B33-151-499	i3300	B30 Monocolour	1500	1
▲	B-499	<b>FNA</b>	50.80	6.35	-	-	-	THT-151-499-3	BBP12, i7100, i5100	R4900	3000	1
▲	B-499	<b>FNA</b>	50.80	6.35	-	-	-	THT-151-499-1.5-SC	BBP12	R7950, R4300, R4900	1500	1
▲	B-488	<b>FA</b>	50.80	6.35	-	-	-	THT-15-488-2.5	BBP12, i7100, i5100	R4300, R7950	2500	1
▲	B-499	<b>FNA</b>	50.80	19.05	-	-	-	M21-137-499	M210, M210-LAB, M211	R4300	1	1
▲	B-423	<b>FAH</b>	50.80	19.05	-	-	-	M21-137-423	M210, M210-LAB, M211	R6000HF	1	1
▲	B-499	<b>FNA</b>	50.80	25.40	-	-	-	B33-137-499	i3300	B30 Monocolour	1100	1
▲	B-423	<b>FAH</b>	50.80	25.40	-	-	-	B33-17-423	i3300	B30 Monocolour	1500	1
▲	B-423	<b>FAH</b>	50.80	25.40	-	-	-	THT-17-423-3	BBP12, i7100, i5100	R6000HF	3000	1
▷	B-461	<b>FNAHSL</b>	63.50	38.10	-	19.05	38.10	M6-157-461	M610, M611	R4300, R6200	100	1
▲	B-423	<b>FAH</b>	69.85	31.75	-	-	-	M7-26-423	M710	R6000HF	100	1
▲	B-423	<b>FAH</b>	76.20	25.40	-	-	-	B33-18-423	i3300	B30 Monocolour	1500	1
▲	B-423	<b>FA</b>	76.20	25.40	-	-	-	M6-22-423	M610, M611	R6000HF, R6200, R4400	100	1
▲	B-423	<b>FAH</b>	76.20	25.40	-	-	-	M7-22-423	M710	R6000HF	100	1
▲	B-423	<b>FAH</b>	76.20	25.40	-	-	-	THT-18-423-3	BBP12, i7100, i5100	R6000HF	3000	1
▷	B-461	<b>FNAHSL</b>	88.90	38.10	-	25.40	15.24	M6-77-461	M610, M611	R4300, R6200	100	1
▲	B-490	<b>FNH L</b>	95.25	38.10	-	-	-	THT-158-490-3	BBP12, i7100, i5100	R4300, R7950	3000	1
▲	B-490	<b>FNH L</b>	95.25	38.10	-	-	-	THT-158-490-1.5-SC	BBP12	R7950	1500	1

**F** Freezer environment    **N** Liquid nitrogen environment    **A** Autoclave environment    **H** Hot water bath (100°C)    **S** Self-laminating label    **L** Low-profile (extremely thin) label    **R** Removable

## Track and trace multiple samples throughout your lab with RFID



- Small size that fits medical well plates, Petri dishes and cell culture dishes.
- Extremely chemical resistant B-7425 label material, especially when printed with ribbon R6400.
- An RFID reader brings every labeled item on-screen within a 1 metre radius, enables specific item selection and guides users to it with visuals and sound.

Diagram	Material	Label Width A (mm)	Label Height B (mm)	Order Reference	Printer Compatibility	Printer Ribbon Series	Labels per Roll	Labels per Row
▲	L-2588-35C	65.00	6.00	THT-UHF-B7425-65x6-0.5	Sato CL4NX Plus, Sato CT4LX	R6400	500	1

# General Lab ID



## B-403 Water dissolvable label

The B-403 water dissolvable paper is self-adhesive and extremely easy to apply. Exposing the label to warm water will completely dissolve it within 30 seconds, without damage to the surface it was applied to, and without leaving any residue. The water dissolvable label adheres well to most surfaces, including glass, stainless steel, aluminium, plastic and others. This makes the label a great solution to enable short term identification for containers, crates and glassware with a minimum of waste.

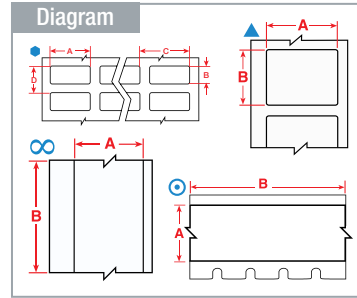

- F** Freezer environment
- A** Autoclave environment
- H** Hot water bath (100°C)
- S** Self-laminating label
- L** Low-profile (extremely thin) label
- R** Removable

Labels are shown in order of label width.

The background colours in the Order Reference column represent the material colour.

See page 54 for Brady's range of label printers.

Diagram	Material	Special Properties	Label Width A (mm)	Label Height B (mm)	Label Length B (m)	Order Reference	Printer Compatibility	Printer Ribbon Series	Labels per Roll	Labels per Row
⊙	B-403	<b>R</b>	12.70	-	7.62	M21-500-403	M210, M210-LAB, M211	R4300	1	-
⊙	B-403	<b>R</b>	19.05	-	15.24	M6C-750-403	M610, M611	R4300	1	1
●	B-403	<b>R</b>	22.86	22.86	-	THT-141-403-3	BBP12, i7100, i5100	R4300	3000	2
∞	B-403	<b>R</b>	28.58	-	30.48	B30C-1125-403-WT	i3300	B30-R4300	1	1
∞	B-403		28.58	-	45.72	JC-1125-403	J7300	-	1	1
∞	B-403	<b>R</b>	28.58	-	91.44	THT-1125-403-WT	BBP12, i7100, i5100	R4300	1	1
▲	B-403	<b>R</b>	38.10	19.05	-	THT-136-403-3	BBP12, i7100, i5100	R4300	3000	1
▲	B-403	<b>R</b>	38.10	-	7.62	M5C-1500-403	M511, BMP51	R4300	1	-
⊙	B-403	<b>R</b>	38.10	-	15.24	M6C-1500-403	M610, M611	R4300	1	1
⊙	B-403	<b>R</b>	38.10	-	15.24	M71C-1500-403	BMP71	R4300	1	1
▲	B-403		50.80	25.40	-	J-17-403	J7300	-	1	1
▲	B-403	<b>R</b>	50.80	25.40	-	THT-17-403-3	BBP12, i7100, i5100	R4300	3000	1
∞	B-403	<b>R</b>	57.15	-	30.48	B30C-2250-403-WT	i3300	B30-R4300	1	1
∞	B-403		57.15	-	45.72	JC-2250-403	J7300	-	1	1
∞	B-403	<b>R</b>	57.15	-	91.44	THT-2250-403-WT	BBP12, i7100, i5100	R4300	1	1
▲	B-403	<b>R</b>	76.20	25.40	-	THT-18-403-3	BBP12, i7100, i5100	R4300	3000	1
▲	B-403		76.20	50.80	-	J-19-403	J7300	-	1	1
▲	B-403	<b>R</b>	76.20	50.80	-	THT-19-403-1	BBP12, i7100, i5100	R4300	1000	1
∞	B-403	<b>R</b>	76.20	-	30.48	B30C-3000-403-WT	i3300	B30-R4300	1	1
▲	B-403		101.60	50.80	-	J-55-403	J7300	-	1	1
▲	B-403	<b>R</b>	101.60	50.80	-	THT-55-403-1	BBP12, i7100, i5100	R4300	1000	1
∞	B-403	<b>R</b>	101.60	-	30.48	B30C-4000-403-WT	i3300	B30-R4300	1	1
∞	B-403	<b>R</b>	101.60	-	91.44	THT-4000-403-WT	BBP12, i7100, i5100	R4300	1	1



## B-7425-AC Sterilisation indicating label

Sterilisation indicating labels provide users with proof of sterilisation. They are ideal for a broad range of laboratory processes including sample tracking, inventory management, general tracking, and glassware or tray identification.

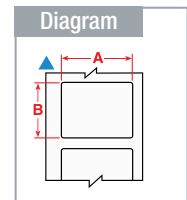
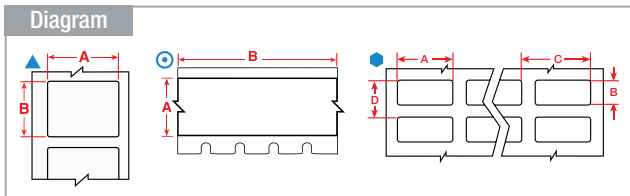

Diagram	Material	Label Width A (mm)	Label Height B (mm)	Order Reference	Printer Compatibility	Printer Ribbon Series	Labels per Roll	Labels per Row
▲	B-7425	38.10	25.40	B33-235-7425-AC	i3300	B30 Monocolour	1250	1
▲	B-7425	38.10	25.40	THT-235-7425-2-AC	BBP12, i7100, i5100	R4300	2000	1
▲	B-7425	50.80	25.40	B33-137-7425-AC	i3300	B30 Monocolour	1500	1
▲	B-7425	50.80	25.40	THT-137-7425-2-AC	BBP12, i7100, i5100	R4300	2000	1



# General Lab ID

- F** Freezer environment
- N** Liquid nitrogen environment
- A** Autoclave environment
- H** Hot water bath (100°C)
- S** Self-laminating label
- L** Low-profile (extremely thin) label
- R** Removable



## General Lab ID

Just like a durable sample label lets you know which sample you are holding, a cabinet or drawer label can inform you of the cabinet's content. With proper identification, time spent looking for the right sample or tool can be invested in what really matters. Brady offers a range of materials suitable for identifying drawers, cabinets, shelves, storage units and laboratory equipment.

Labels are shown in order of label width.

The background colours in the Order Reference column represent the material colour.

See page 54 for Brady's range of label printers.

Diagram	Material	Special Properties	Label Width A (mm)	Label Height B (mm)	Label Length B (m)	Order Reference	Printer Compatibility	Printer Ribbon Series	Labels per Roll	Labels per Row
●	B-499	<b>F N A</b>	6.35	36.50	—	B33-90-499	i3300, i5300	B30 Monocolour	2500	6
○	B-595	<b>F</b>	6.35	—	6.40	M21-250-595-WT	M210-LAB, M211	R6000HF	1	—
○	B-595	<b>F</b>	6.35	—	6.40	M21-250-595-YL	M210-LAB, M211	R6000HF	1	—
○	B-423	<b>F A H</b>	6.35	—	6.40	M21-250-423	M210-LAB, M211	R6200	1	—
○	B-499	<b>F N A</b>	9.53	—	4.88	M21-375-499	M210-LAB, M211	R4300	1	—
○	B-499	<b>F N A</b>	9.53	—	4.88	M4C-375-499	M511, BMP41, BMP51	R4300	1	—
○	B-423	<b>F A H</b>	9.53	—	6.40	M21-375-423	M210-LAB, M211	R6200	1	—
○	B-488	<b>F A</b>	9.53	—	6.40	M21-375-488	M210-LAB, M211	R4300	1	—
○	B-595	<b>F</b>	9.53	—	6.40	M21-375-595-PL	M210-LAB, M211	R4400	1	—
○	B-595	<b>F</b>	9.53	—	6.40	M21-375-595-BR	M210-LAB, M211	R4400	1	—
○	B-595	<b>F</b>	9.53	—	6.40	M21-375-595-GY	M210-LAB, M211	R6000HF	1	—
○	B-595	<b>F</b>	9.53	—	6.40	M21-375-595-BK	M210-LAB, M211	R4400	1	—
○	B-595	<b>F</b>	9.53	—	6.40	M21-375-595-WT	M210-LAB, M211	R6000HF	1	—
○	B-595	<b>F</b>	9.53	—	6.40	M21-375-595-GN	M210-LAB, M211	R4400	1	—
○	B-595	<b>F</b>	9.53	—	6.40	M21-375-595-YL	M210-LAB, M211	R6000HF	1	—
○	B-595	<b>F</b>	9.53	—	6.40	M21-375-595-BL	M210-LAB, M211	R4400	1	—
○	B-595	<b>F</b>	9.53	—	6.40	M21-375-595-OR	M210-LAB, M211	R6000HF	1	—
○	B-595	<b>F</b>	9.53	—	6.40	M21-375-595-RD	M210-LAB, M211	R4400	1	—
○	B-595	<b>F</b>	9.53	—	7.62	M4C-375-595-WT-BK	M511, BMP41, BMP51	R6000HF	1	—
○	B-595	<b>F</b>	9.53	—	7.62	M4C-375-595-YL-BK	M511, BMP41, BMP51	R6000HF	1	—
○	B-595	<b>F</b>	9.53	—	7.62	M4C-375-595-RD-WT	M511, BMP41, BMP51	R4400	1	—
●	B-499	<b>F N A</b>	12.70	36.50	—	B33-87-499	i3300, i5300	B30 Monocolour	2500	6
●	B-7425J	<b>F N A H</b>	12.70	38.10	—	J-37-7425J	J7300		1	2
▲	B-490	<b>F N H L</b>	12.70	41.91	—	M6-124-490	M610, M611	R4300	500	1
○	B-499	<b>F N A</b>	12.70	—	4.88	M21-500-499	M210-LAB, M211	R4300	1	—
○	B-499	<b>F N A</b>	12.70	—	4.88	M4C-500-499	M511, BMP41, BMP51	R4300	1	—
○	B-595	<b>F</b>	12.70	—	6.10	M4C-500-595-CL-BK	M511, BMP41, BMP51	R6000HF	1	—
○	B-595	<b>F</b>	12.70	—	6.10	M4C-500-595-CL-WT	M511, BMP41, BMP51	R4400	1	—
○	B-423	<b>F A H</b>	12.70	—	6.40	M21-500-423	M210-LAB, M211	R6200	1	—
○	B-488	<b>F A</b>	12.70	—	6.40	M21-500-488	M210-LAB, M211	R4300	1	—
○	B-595	<b>F</b>	12.70	—	6.40	M21-500-595-PL	M210-LAB, M211	R4400	1	—
○	B-595	<b>F</b>	12.70	—	6.40	M21-500-595-BR	M210-LAB, M211	R4400	1	—
○	B-595	<b>F</b>	12.70	—	6.40	M21-500-595-GY	M210-LAB, M211	R6000HF	1	—
○	B-595	<b>F</b>	12.70	—	6.40	M21-500-595-BK	M210-LAB, M211	R4400	1	—
○	B-595	<b>F</b>	12.70	—	6.40	M21-500-595-RD	M210-LAB, M211	R4400	1	—
○	B-595	<b>F</b>	12.70	—	6.40	M21-500-595-OR	M210-LAB, M211	R6000HF	1	—
○	B-595	<b>F</b>	12.70	—	6.40	M21-500-595-BL	M210-LAB, M211	R4400	1	—
○	B-595	<b>F</b>	12.70	—	6.40	M21-500-595-YL	M210-LAB, M211	R6000HF	1	—
○	B-595	<b>F</b>	12.70	—	6.40	M21-500-595-GN	M210-LAB, M211	R4400	1	—
○	B-595	<b>F</b>	12.70	—	6.40	M21-500-595-WT	M210-LAB, M211	R6000HF	1	—
○	B-595	<b>F</b>	12.70	—	7.62	M4C-500-595-GN-WT	M511, BMP41, BMP51	R4400	1	—
○	B-595	<b>F</b>	12.70	—	7.62	M4C-500-595-OR-BK	M511, BMP41, BMP51	R6000HF	1	—
○	B-595	<b>F</b>	12.70	—	7.62	M4C-500-595-RD-WT	M511, BMP41, BMP51	R4400	1	—
○	B-595	<b>F</b>	12.70	—	7.62	M4C-500-595-WT-BK	M511, BMP41, BMP51	R6000HF	1	—
○	B-595	<b>F</b>	12.70	—	7.62	M4C-500-595-WT-RD	M511, BMP41, BMP51	R4400	1	—
○	B-595	<b>F</b>	12.70	—	7.62	M4C-500-595-YL-BK	M511, BMP41, BMP51	R6000HF	1	—
○	B-595	<b>F</b>	12.70	—	7.62	M4C-500-595-BK-WT	M511, BMP41, BMP51	R4400	1	—
○	B-499	<b>F N A</b>	12.70	—	9.14	M7C-500-499	M710	R4300, R6000HF, R6200	1	1
○	B-595	<b>F</b>	12.70	—	15.24	M7C-500-595-YL	M710	R6000HF, R4400-WT	1	1

>>

# General Lab ID

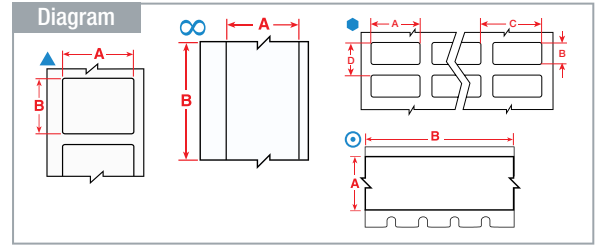
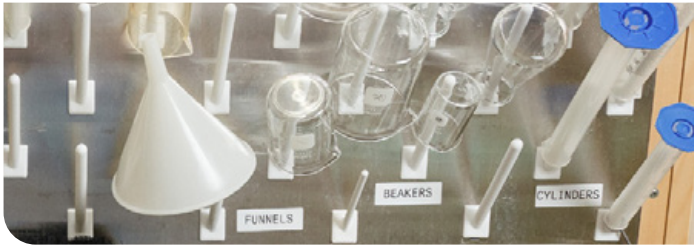

Labels are shown in order of label width.

The background colours in the Order Reference column represent the material colour.

See page 54 for Brady's range of label printers.

Diagram	Material	Special Properties	Label Width A (mm)	Label Height B (mm)	Label Length B (m)	Order Reference	Printer Compatibility	Printer Ribbon Series	Labels per Roll	Labels per Row
⊙	B-595	F	12.70	-	15.24	M7C-500-595-WT	M710	R6000HF	1	1
⊙	B-595	F	12.70	-	15.24	M7C-500-595-RD	M710	R6000HF, R4400-WT	1	1
⊙	B-595	F	12.70	-	15.24	M7C-500-595-OR	M710	R6000HF, R4400-WT	1	1
⊙	B-595	F	12.70	-	15.24	M7C-500-595-GN	M710	R6000HF, R4400-WT	1	1
⊙	B-595	F	12.70	-	15.24	M7C-500-595-CL	M710	R6000HF, R4400-WT	1	1
⊙	B-595	F	12.70	-	15.24	M7C-500-595-BL	M710	R6000HF, R4400-WT	1	1
⊙	B-595	F	12.70	-	15.24	M7C-500-595-BK	M710	R4400-WT	1	1
⊙	B-492	F N H L	12.70	-	15.24	M6C-500-492	M610, M611	R6000HF, R4400	1	1
∞	B-595	F	12.70	-	30.48	B30C-500-595-BK	i3300	B30-R10000-WT	1	1
∞	B-595	F	12.70	-	30.48	B30C-500-595-BL	i3300	B30-R10000-WT	1	1
∞	B-595	F	12.70	-	30.48	B30C-500-595-CL	i3300	B30-R10000	1	1
∞	B-595	F	12.70	-	30.48	B30C-500-595-GN	i3300	B30-R10000-WT	1	1
∞	B-595	F	12.70	-	30.48	B30C-500-595-OR	i3300	B30-R10000	1	1
∞	B-595	F	12.70	-	30.48	B30C-500-595-RD	i3300	B30-R10000-WT	1	1
∞	B-595	F	12.70	-	30.48	B30C-500-595-WT	i3300	B30-R10000	1	1
∞	B-595	F	12.70	-	30.48	B30C-500-595-YL	i3300	B30-R10000	1	1
▲	B-490	F N H L	15.24	45.72	-	M6-126-490	M610, M611	R4300	250	1
●	B-499	F N A	19.05	6.35	-	B33-1-499	i3300, i5300	B30 Monocolour	10000	4
▲	B-499	F N A	19.05	12.70	-	M21-11-499	M210-LAB, M211	R4300	1	1
▲	B-423	F A H	19.05	12.70	-	M21-7-423	M210-LAB, M211	R6000HF	1	1
▲	B-499	F N A	19.05	19.05	-	B33-254-499	i3300, i5300	B30 Monocolour	1000	1
●	B-499	F N A	19.05	23.80	-	B33-91-499	i3300, i5300	B30 Monocolour	2500	4
⊙	B-499	F N A	19.05	-	4.88	M21-750-499	M210-LAB, M211	R4300	1	-
⊙	B-499	F N A	19.05	-	4.88	M4C-750-499	M511, BMP41, BMP51	R4300	1	-
⊙	B-595	F	19.05	-	6.10	M4C-750-595-CL-BK	M511, BMP41, BMP51	R6000HF	1	-
⊙	B-595	F	19.05	-	6.10	M4C-750-595-CL-WT	M511, BMP41, BMP51	R4400	1	-
⊙	B-423	F A H	19.05	-	6.40	M21-750-423	M210-LAB, M211	R6200	1	-
⊙	B-488	F A	19.05	-	6.40	M21-750-488	M210-LAB, M211	R4300	1	-
⊙	B-595	F	19.05	-	6.40	M21-750-595-PL	M210-LAB, M211	R4400	1	-
⊙	B-595	F	19.05	-	6.40	M21-750-595-BR	M210-LAB, M211	R4400	1	-
⊙	B-595	F	19.05	-	6.40	M21-750-595-GY	M210-LAB, M211	R6000HF	1	-
⊙	B-595	F	19.05	-	6.40	M21-750-595-BK	M210-LAB, M211	R4400	1	-
⊙	B-595	F	19.05	-	6.40	M21-750-595-BL	M210-LAB, M211	R4400	1	-
⊙	B-595	F	19.05	-	6.40	M21-750-595-WT	M210-LAB, M211	R6000HF	1	-
⊙	B-595	F	19.05	-	6.40	M21-750-595-RD	M210-LAB, M211	R4400	1	-
⊙	B-595	F	19.05	-	6.40	M21-750-595-OR	M210-LAB, M211	R6000HF	1	-
⊙	B-595	F	19.05	-	6.40	M21-750-595-GN	M210-LAB, M211	R4400	1	-
⊙	B-595	F	19.05	-	6.40	M21-750-595-YL	M210-LAB, M211	R6000HF	1	-
⊙	B-403	R	19.05	-	7.62	M4C-750-403	M511, BMP51	R4300	1	-
⊙	B-595	F	19.05	-	7.62	M4C-750-595-BK-WT	M511, BMP41, BMP51	R4400	1	-
⊙	B-595	F	19.05	-	7.62	M4C-750-595-BL-WT	M511, BMP41, BMP51	R4400	1	-
⊙	B-595	F	19.05	-	7.62	M4C-750-595-GN-WT	M511, BMP41, BMP51	R4400	1	-
⊙	B-595	F	19.05	-	7.62	M4C-750-595-OR-BK	M511, BMP41, BMP51	R6000HF	1	-
⊙	B-595	F	19.05	-	7.62	M4C-750-595-RD-WT	M511, BMP41, BMP51	R4400	1	-
⊙	B-595	F	19.05	-	7.62	M4C-750-595-WT-BK	M511, BMP41, BMP51	R6000HF	1	-
⊙	B-595	F	19.05	-	7.62	M4C-750-595-WT-RD	M511, BMP41, BMP51	R4400	1	-
⊙	B-595	F	19.05	-	7.62	M4C-750-595-YL-BK	M511, BMP41, BMP51	R6000HF	1	-
⊙	B-403	R	19.05	-	15.24	M6C-750-403	M610, M611	R4300	1	1
▲	B-499	F N A	20.96	9.53	-	M4-130-499	M511, BMP41, BMP51	R4300	220	-
▲	B-481	F H	22.86	9.53	-	M6-195-481	M610, M611	R6400	500	1
▲	B-481	F H	22.86	19.05	-	M6-194-481	M610, M611	R6400	250	1
▲	B-481	F H	22.86	22.86	-	M6-97-481	M610, M611	R6400	250	1
⊕	B-7425J	F N A H	25.40	9.53	-	J-249-7425J	J7300		1	1
●	B-423	F A H	25.40	12.70	-	B33-5-423	i3300	B30 Monocolour	5000	3
▲	B-499	F N A	25.40	12.70	-	M21-131-499	M210-LAB, M211	R4300	1	1
▲	B-423	F A H	25.40	12.70	-	M21-17-423	M210-LAB, M211	R6000HF	1	1

>>

**F** Freezer environment    **N** Liquid nitrogen environment    **A** Autoclave environment    **H** Hot water bath (100°C)    **S** Self-laminating label    **L** Low-profile (extremely thin) label    **R** Removable

# General Lab ID

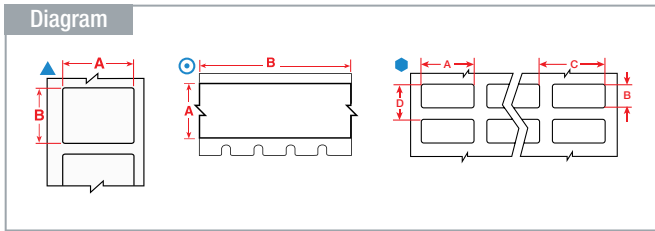

Labels are shown in order of label width.

The background colours in the Order Reference column represent the material colour.

See page 54 for Brady's range of label printers.

Diagram	Material	Special Properties	Label Width A (mm)	Label Height B (mm)	Label Length B (m)	Order Reference	Printer Compatibility	Printer Ribbon Series	Labels per Roll	Labels per Row
●	B-499	<b>FNA</b>	25.40	12.70	—	B33-5-499	i3300, i5300	B30 Monocolour	5000	3
▲	B-499	<b>FNA</b>	25.40	12.70	—	M4-131-499	M511, BMP41, BMP51	R4300	180	—
▲	B-7425	<b>FNAH</b>	25.40	12.70	—	M6-17-7425	M610, M611	R4300, R6400	500	1
▲	B-7425J	<b>FNAH</b>	25.40	12.70	—	J-59-7425J	J7300		1	1
⊕	B-7425J	<b>FNAH</b>	25.40	12.70	—	J-251-7425J	J7300		1	1
●	B-488	<b>FA</b>	25.40	12.70	—	THT-5-488-10	BBP12, i7100, i5100	R4300, R7950	10000	3
▲	B-499	<b>FNA</b>	25.40	19.05	—	M21-18-499	M210-LAB, M211	R4300	1	1
▲	B-423	<b>FAH</b>	25.40	19.05	—	M21-18-423	M210-LAB, M211	R6000HF	1	1
●	B-499	<b>FNA</b>	25.40	19.05	—	B33-88-499	i3300, i5300	B30 Monocolour	2500	2
▲	B-7425	<b>FNAH</b>	25.40	19.05	—	M6-18-7425	M610, M611	R4300, R6400	250	1
●	B-7425J	<b>FNAH</b>	25.40	19.05	—	J-88-7425J	J7300		1	2
▲	B-499	<b>FNA</b>	25.40	25.40	—	M7-19-499	M710	R4300, R6000HF, R6200	250	1
▲	B-492	<b>FNAHL</b>	25.40	25.40	—	M7-19-492	M710	R6400	250	1
●	B-499	<b>FNA</b>	25.40	36.50	—	B33-89-499	i3300, i5300	B30 Monocolour	2300	3
▲	B-424	<b>F</b>	25.40	50.80	—	M7-20-424	M710	R4300	100	1
●	B-499	<b>FNA</b>	25.40	63.50	—	B33-325-499	i3300, i5300	B30 Monocolour	700	2
●	B-499	<b>FNA</b>	25.40	101.60	—	B33-326-499	i3300, i5300	B30 Monocolour	450	2
○	B-499	<b>FNA</b>	25.40	—	4.88	M5C-1000-499	M511, BMP51	R4300	1	—
○	B-595	<b>F</b>	25.40	—	6.10	M4C-1000-595-CL-BK	M511, BMP41, BMP51	R6000HF	1	—
○	B-595	<b>F</b>	25.40	—	6.10	M4C-1000-595-CL-WT	M511, BMP41, BMP51	R4400	1	—
○	B-595	<b>F</b>	25.40	—	7.62	M4C-1000-595-WT-BK	M511, BMP41, BMP51	R6000HF	1	—
○	B-595	<b>F</b>	25.40	—	7.62	M4C-1000-595-YL-BK	M511, BMP41, BMP51	R6000HF	1	—
○	B-595	<b>F</b>	25.40	—	7.62	M4C-1000-595-OR-BK	M511, BMP41, BMP51	R6000HF	1	—
○	B-595	<b>F</b>	25.40	—	7.62	M4C-1000-595-BL-WT	M511, BMP41, BMP51	R4400	1	—
○	B-595	<b>F</b>	25.40	—	7.62	M4C-1000-595-RD-WT	M511, BMP41, BMP51	R4400	1	—
○	B-595	<b>F</b>	25.40	—	7.62	M4C-1000-595-GN-WT	M511, BMP41, BMP51	R4400	1	—
○	B-595	<b>F</b>	25.40	—	7.62	M4C-1000-595-WT-RD	M511, BMP41, BMP51	R4400	1	—
○	B-595	<b>F</b>	25.40	—	7.62	M4C-1000-595-BK-WT	M511, BMP41, BMP51	R4400	1	—
○	B-499	<b>FNA</b>	25.40	—	9.14	M7C-1000-499	M710	R4300, R6000HF, R6200	1	1
○	B-595	<b>F</b>	25.40	—	15.24	M7C-1000-595-YL	M710	R6000HF, R4400-WT	1	1
○	B-595	<b>F</b>	25.40	—	15.24	M7C-1000-595-WT	M710	R6000HF	1	1
○	B-595	<b>F</b>	25.40	—	15.24	M7C-1000-595-RD	M710	R6000HF, R4400-WT	1	1
○	B-595	<b>F</b>	25.40	—	15.24	M7C-1000-595-OR	M710	R6000HF, R4400-WT	1	1
○	B-595	<b>F</b>	25.40	—	15.24	M7C-1000-595-GN	M710	R6000HF, R4400-WT	1	1
○	B-595	<b>F</b>	25.40	—	15.24	M7C-1000-595-CL	M710	R6000HF, R4400-WT	1	1
○	B-595	<b>F</b>	25.40	—	15.24	M7C-1000-595-BL	M710	R6000HF, R4400-WT	1	1
○	B-595	<b>F</b>	25.40	—	15.24	M7C-1000-595-BK	M710	R4400-WT	1	1
○	B-430	<b>FAH</b>	25.40	—	15.24	M7C-1000-430	M710	R6000HF	1	1
▲	B-7425	<b>FNAH</b>	33.02	15.24	—	M6-199-7425	M610, M611	R4300, R6400	250	1
▲	B-499	<b>FNA</b>	38.10	19.05	—	M21-136-499	M210-LAB, M211	R4300	1	1
▲	B-423	<b>FAH</b>	38.10	19.05	—	M21-30-423	M210-LAB, M211	R6000HF	1	1
▲	B-7425J	<b>FNAH</b>	38.10	19.05	—	J-136-7425J	J7300		1	1
●	B-423	<b>FAH</b>	38.10	19.05	—	THT-6-423-10	BBP12, i7100, i5100	R6000HF	10000	2
▲	B-7425J	<b>FNAH</b>	38.10	25.40	—	J-235-7425J	J7300		1	1
▲	B-499	<b>FNA</b>	38.10	31.75	—	M5-132-499	M511, BMP51	R4300	160	—
▲	B-7425J	<b>FNAH</b>	38.10	44.45	—	J-258-7425J	J7300		1	1
●	B-499	<b>FNA</b>	38.10	101.60	—	B33-327-499	i3300, i5300	B30 Monocolour	450	2
●	B-499	<b>FNA</b>	38.10	152.40	—	B33-328-499	i3300, i5300	B30 Monocolour	300	2
○	B-595	<b>F</b>	38.10	—	6.10	M5C-1500-595-CL-BK	M511, BMP51	R6000HF	1	—
○	B-595	<b>F</b>	38.10	—	6.10	M5C-1500-595-CL-WT	M511, BMP51	R4400	1	—
○	B-403	<b>R</b>	38.10	—	7.62	M5C-1500-403	M511, BMP51	R4300	1	—
○	B-595	<b>F</b>	38.10	—	7.62	M5C-1500-595-BL-WT	M511, BMP51	R4400	1	—
○	B-595	<b>F</b>	38.10	—	7.62	M5C-1500-595-GN-WT	M511, BMP51	R4400	1	—
○	B-595	<b>F</b>	38.10	—	7.62	M5C-1500-595-OR-BK	M511, BMP51	R6000HF	1	—
○	B-595	<b>F</b>	38.10	—	7.62	M5C-1500-595-RD-WT	M511, BMP51	R4400	1	—
○	B-595	<b>F</b>	38.10	—	7.62	M5C-1500-595-WT-BK	M511, BMP51	R6000HF	1	—

>>

**F** Freezer environment   **N** Liquid nitrogen environment   **A** Autoclave environment   **H** Hot water bath (100°C)   **S** Self-laminating label   **L** Low-profile (extremely thin) label   **R** Removable

# General Lab ID

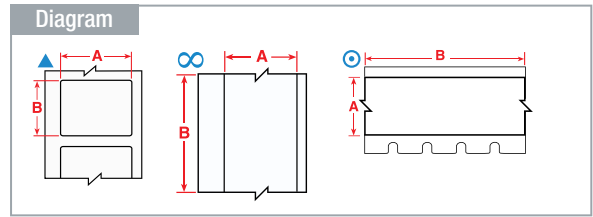

Labels are shown in order of label width.

The background colours in the Order Reference column represent the material colour.

See page 54 for Brady's range of label printers.

Diagram	Material	Special Properties	Label Width A (mm)	Label Height B (mm)	Label Length B (m)	Order Reference	Printer Compatibility	Printer Ribbon Series	Labels per Roll	Labels per Row
⊙	B-595	<b>F</b>	38.10	–	7.62	M5C-1500-595-WT-RD	M511, BMP51	R4400	1	–
⊙	B-595	<b>F</b>	38.10	–	7.62	M5C-1500-595-YL-BK	M511, BMP51	R6000HF	1	–
⊙	B-595	<b>F</b>	38.10	–	7.62	M5C-1500-595-BK-WT	M511, BMP51	R4400	1	–
⊙	B-403	<b>R</b>	38.10	–	15.24	M6C-1500-403	M610, M611	R4300	1	1
▲	B-7425J	<b>F N A H</b>	48.26	25.40	–	J-156-7425J	J7300		1	1
⊙	B-499	<b>F N A</b>	48.26	–	9.14	M7C-1900-499	M710	R4300, R6000HF, R6200	1	1
▲	B-423	<b>F A H</b>	50.80	12.70	–	THT-53-423-3	BBP12, i7100, i5100	R6000HF	3000	1
▲	B-424	<b>F</b>	50.80	12.70	–	B33-53-424	i3300	B30 Monocolour	2500	1
▲	B-424	<b>F</b>	50.80	12.70	–	THT-53-424-3	BBP12, i7100, i5100	R4300, R7950	3000	1
▲	B-499	<b>F N A</b>	50.80	19.05	–	M21-137-499	M210-LAB, M211	R4300	1	1
▲	B-423	<b>F A H</b>	50.80	19.05	–	M21-137-423	M210-LAB, M211	R6000HF	1	1
▲	B-424	<b>F</b>	50.80	25.40	–	B33-17-424	i3300	B30 Monocolour	1500	1
▲	B-423	<b>F A H</b>	50.80	25.40	–	B33-17-423	i3300	B30 Monocolour	1500	1
▲	B-424	<b>F</b>	50.80	25.40	–	BM-20-424	M610, M611, M710	R4300	1000	1
▲	B-7425J	<b>F N A H</b>	50.80	25.40	–	J-137-7425J	J7300		1	1
▲	B-423	<b>F A H</b>	50.80	25.40	–	THT-17-423-3	BBP12, i7100, i5100	R6000HF	3000	1
▲	B-424	<b>F</b>	50.80	25.40	–	THT-17-424-3	BBP12, i7100, i5100	R4300, R7950	3000	1
▲	B-449	<b>F A</b>	50.80	25.40	–	THT-17-449-3	BBP12, i7100, i5100	R4300, R7950	3000	1
▲	B-7425J	<b>F N A H</b>	55.12	85.09	–	J40-260-7425J	J4000		340	1
∞	B-7425J	<b>F N A H</b>	57.15	–	30.48	J40C-2250-7425J	J4000		1	1
▲	B-423	<b>F A H</b>	69.85	31.75	–	M7-26-423	M710	R6000HF	100	1
▲	B-423	<b>F A H</b>	76.20	25.40	–	B33-18-423	i3300	B30 Monocolour	1500	1
▲	B-423	<b>F A H</b>	76.20	25.40	–	THT-18-423-3	BBP12, i7100, i5100	R6000HF	3000	1
▲	B-7425J	<b>F N A H</b>	76.20	50.80	–	J-19-7425J	J7300		1	1
▲	B-7425J	<b>F N A H</b>	88.90	127.00	–	J-371-7425J	J7300		1	1
∞	B-7425J	<b>F N A H</b>	101.60	–	30.48	J40C-4000-7425J	J4000		1	1
▲	B-7425J	<b>F N A H</b>	104.90	154.94	–	J40-262-7425J	J4000		200	1
∞	B-7425J	<b>F N A H</b>	152.40	–	30.48	J40C-6000-7425J	J4000		1	1
▲	B-7425J	<b>F N A H</b>	177.80	254.00	–	J40-265-7425J	J4000		100	1
▲	B-7425J	<b>F N A H</b>	203.20	133.35	–	J40-321-2475J	J4000		100	1
▲	B-7425J	<b>F N A H</b>	203.20	279.40	–	J40-268-2475J	J4000		100	1
∞	B-7425J	<b>F N A H</b>	203.20	–	30.48	J40C-8000-7425J	J4000		1	1

**F** Freezer environment    **N** Liquid nitrogen environment    **A** Autoclave environment    **H** Hot water bath (100°C)    **S** Self-laminating label    **L** Low-profile (extremely thin) label    **R** Removable



## Asset Tracking RFID Labels

Track assets and manage inventories more efficiently in complex laboratory environments with RFID labels that can fit any surface. Give every asset a unique digital identity your readers can radio in on, so you'll know where your assets are, without needing line of sight.

Diagram	Material	Label Width A (mm)	Label Height B (mm)	Order Reference	Printer Compatibility	Printer Ribbon Series	Labels per Roll	Labels per Row
▲	L-2588-19A	45.00	30.00	THT-UHF-7425-45X30-0.1	Sato CL4NX Plus, Sato CT4LX	R7961	500	1
▲	L-2588-26B	53.00	26.00	THT-UHF-7425-53X26-0.5	Sato CL4NX Plus, Sato CT4LX	R6400	500	1
▲	L-2588-26C	53.00	26.00	THT-UHF-423-53X26	Sato CL4NX Plus, Sato CT4LX	R6000HF	500	1



## Label Printers and Barcode Scanners

Brady printers enable professionals to print highly specialised identification labels on-site and on demand. Partnered with labelling software for laboratories, Brady printers support considerable time savings and flexibility in sample identification. To complete your sample ID automation, Brady has a range of barcode scanners which combine the industry's best imaging technology with a graphic display and rugged keyboard for fast, user-friendly data and inventory management.

- 54 Choose Your Printer
- 58 M210-LAB Label Printer
- 59 M211 Label Printer
- 60 M511 Label Printer
- 61 M510 Label Printer
- 62 M610 Label Printer
- 63 M611 Label Printer
- 64 M710 Label Printer
- 65 BBP12 Label Printer
- 66 BradyPrinter i3300 Industrial Label Printer
- 67 BradyPrinter i5100 Industrial Label Printer
- 68 BradyPrinter i5300 Industrial Label Printer
- 69 BradyPrinter i7100 Industrial Label Printer
- 71 BradyJet™ J7300 Colour Label Printer
- 72 BradyJet™ J4000 Colour Label Printer
- 73 Label Creation Software
- 74 Barcode readers for Laboratories

## Choose Your Printer - portable printers



	M210-LAB Label Printer	M211 Label Printer	M511 Label Printer
Recommended Usage per Day	100	100	1000
Resolution (dpi)	203 dpi	203 dpi	300 dpi
Print Technology	Thermal Transfer	Thermal Transfer	Thermal Transfer
Print Speed (mm/sec)	10.00 mm/s	15.24 mm/s	33.80 mm/s
Max. Label Width (mm)	19.05 mm	19.05 mm	38.10 mm
Text Sizes (pt)	6 - 40 pt	4 - 150 pt	4 - 150 pt
Max Print Width	16.00 mm	15.75 mm	36.58 mm
Bar Code Capability	Code 128, Code 39, Data Matrix, QR code	Code 128, Code 128A, Code 128B, Code 128C, Code 39, Code 39 Full ASCII, Code 93, Code 93 Full ASCII, EAN-13, EAN-13 Extension 2, EAN-13 Extension 5, EAN-8, EAN-8 Extension 2, EAN-8 Extension 5, GS1-128, HIBC, Interleaved 2 of 5, JAN-13, JAN-8, UPC-A, UPC-E, Data Matrix, PDF417, QR code	Code 128, Code 128A, Code 128B, Code 128C, Code 39, Code 39 Full ASCII, Code 93, Code 93 Full ASCII, EAN-13, EAN-13 Extension 2, EAN-13 Extension 5, EAN-8, EAN-8 Extension 2, EAN-8 Extension 5, GS1-128, HIBC, Interleaved 2 of 5, JAN-13, JAN-8, UPC-A, UPC-E, Data Matrix, PDF417, QR code, more through Brady Workstation
Built-in Symbols	133	Dependant on software	Dependant on software
Flash Memory	16 MB (2 MB available for storage, stores 12 labels)	Memory via connected mobile device	Memory via connected mobile device
Stand-alone Printing (Detached from PC)	Stand-alone	Mobile device connected, Peripheral	Mobile device connected, Peripheral
Colour Capability	Monocolour	Monocolour	Monocolour
Connectivity	None	Bluetooth® 5 Low Energy (class II)	Bluetooth® 5 Low Energy (class II), USB
Keyboard	ABC	None	None
Power Supply	Batteries, Rechargeable Battery, AC Adaptor	AC Adaptor, Rechargeable Battery, USB	AC Adaptor, Rechargeable Battery, USB
Weight (kg)	0.75 kg	0.54 kg	1.2 kg
Warranty	2 years	2 years	2 years



## Choose Your Printer - portable printers



M510 Label Printer	M610 Label Printer	M611 Label Printer	M710 Label Printer
1000	750	750	1000
300 dpi	300 dpi	300 dpi	300 dpi
Thermal Transfer	Thermal Transfer	Thermal Transfer	Thermal Transfer
38.10 mm/s	50.80 mm/s	50.80 mm/s	76.20 mm/s
38.10 mm	50.80 mm	50.80 mm	50.80 mm
4 - 170 pt	4 - 170 pt	Determined by software	4 - 174 pt
36.58 mm	50.80 mm	50.80 mm	48.79 mm
Code 128, Code 39, EAN-13, EAN-8, Interleaved 2 of 5, UPC-A, UPC-E, Data Matrix, QR code, more through Brady WorkStation	Code 128, Code 39, Interleaved 2 of 5, UPC-A, UPC-E, EAN-8, EAN-13, QR code, Data Matrix, more through Brady WorkStation	Code 128A, Code 128B, Code 128C, Code 39, GS1 DataBar, HIBC, Interleaved 2 of 5, UPC-A, UPC-E, Data Matrix, More through Brady Workstation, PDF417, QR code	Code 128, Code 39, EAN-8, EAN-13, Interleaved 2 of 5, UPC-A, UPC-E, Data Matrix, QR code, more through Brady Workstation
480	480	Dependant on software	500+
512 MB RAM, 256 MB Flash	512 MB RAM, 256 MB Flash	256 MB Flash, 512 MB RAM	200 MB (stores up to 100,000 labels)
Stand-alone & Peripheral	Stand-alone & Peripheral, Mobile device connected	Mobile device connected, Peripheral	Stand-alone & Peripheral, Mobile device connected
Monocolour	Monocolour	Monocolour	Monocolour
USB 2.0, Standalone Use	USB 2.0, Standalone Use, Bluetooth (optional)	Bluetooth® 5 Low Energy (class II), USB, USB 2.0, Wi-Fi	Bluetooth, Wi-Fi, Standalone Use, USB 2.0, USB-C
QWERTY	QWERTY, QWERTZ, AZERTY, CYRILLIC	None	QWERTY, QWERTZ, AZERTY, CYRILLIC
AC Adaptor, Rechargeable Battery	AC Adaptor, Rechargeable Battery	AC Adaptor, Rechargeable Battery	AC Adaptor, Rechargeable Battery
1.38 kg	1.41 kg	1.6 kg	2.45 kg
2 years	2 years	2 years	2 years



## Choose Your Printer - benchtop printers



	BBP12 Label Printer	BradyPrinter i3300 Industrial Label Printer	BradyPrinter i5100 Industrial Label Printer
<b>Recommended Usage per Day</b>	1000	3000	5000
<b>Resolution (dpi)</b>	300 dpi	300 dpi	300 / 600
<b>Print Technology</b>	Thermal Transfer	Thermal Transfer	Thermal Transfer
<b>Print Speed (mm/sec)</b>	101.60 mm/s	101.60 mm/s	300.00 mm/s
<b>Max. Label Width (mm)</b>	116.84 mm	107.95 mm	105.66 mm
<b>Text Sizes (pt)</b>	–	4 - 250 pt	–
<b>Max Print Width</b>	105.41 mm	101.98 mm	105.66 mm
<b>Bar Code Capability</b>	China Post, Codabar, Code 11, Code 128A, Code 128B, Code 128C, Code 128UCC, Code 39, Code 39 with check digit, Code 49, Code 93, Deutsche Post Identcode, Deutsche Post Leitcode, EAN-13, EAN-8, GS1 DataBar, GS1 DataBar Stacked Omnidirectional, GS1-128, Interleaved 2 of 5, Interleaved 2 of 5 with check digit, ITF-14, MSI, MSI with check digit, PLANET, Plessey, POSTNET, Telepen, UPC-A, UPC-E, Aztec, GS1 DataMatrix, MaxiCode, MicroPDF417, PDF417, QR code	Code 128A, Code 128B, Code 128C, Code 39, Code 93, EAN-13, EAN-8, HIBC, Interleaved 2 of 5, Interleaved 2 of 5 with check digit, JAN-13, JAN-8, UPC-A, Aztec, Data Matrix, MicroPDF417, PDF417, QR code	Codabar, Codablock F, Code 128A, Code 128B, Code 128C, Code 39, Code 39 Full ASCII, Code 93, Deutsche Post Identcode, Deutsche Post Leitcode, EAN/UCC 128, EAN/UPC, EAN/UPC Extension 2, EAN/UPC Extension 5, EAN-13, EAN-8, FIM, GS1 DataBar, GS1 DataBar Limited, GS1 DataBar Stacked, GS1 DataBar Stacked Omnidirectional, GS1 DataBar Truncated, GS1-128, HIBC, Interleaved 2 of 5, JAN-8, MSI, Plessey, POSTNET, UPC-A, UPC-E, UPC-E0, Aztec, Data Matrix, GS1 DataMatrix, MaxiCode, MicroPDF417, PDF417, QR code
<b>Built-in Symbols</b>	See Brady Workstation Software	See Brady Workstation Software	See Brady Workstation Software
<b>Flash Memory</b>	128 MB Flash, 64 MB SDRAM, SD Flash memory card up to 32 GB	512 MB RAM, 195 MB IFFS Flash	256 MB RAM, 50 MB IFFS Flash
<b>Stand-alone Printing (Detached from PC)</b>	Peripheral	Peripheral	Stand-alone & Peripheral
<b>Colour Capability</b>	Monocolour	Monocolour	Monocolour
<b>Connectivity</b>	Ethernet, Serial, USB	Ethernet, USB, USB 2.0	Ethernet, Wi-Fi (optional), Bluetooth (optional), Serial, USB
<b>Keyboard</b>	Optional	None	None
<b>Hardware Options</b>	Cleaning swabs, Cutter (factory installed option), External media holder, Peel & Present, Universal keyboard	Cleaning kit, Cleaning swabs, Cutter cleaning tool, Media wipers, Power cord, USB cable	Auto cutter, Bluetooth adapter, Cleaning swabs, Label roll holder, Media roll holder, Platen rollers, Print roller, Ribbon take up spindle, WLAN USB stick
<b>Weight (kg)</b>	2.3 kg	5.22 kg	6.17 kg
<b>Warranty</b>	1 year	1 year	2 years





## Choose Your Printer - benchtop printers

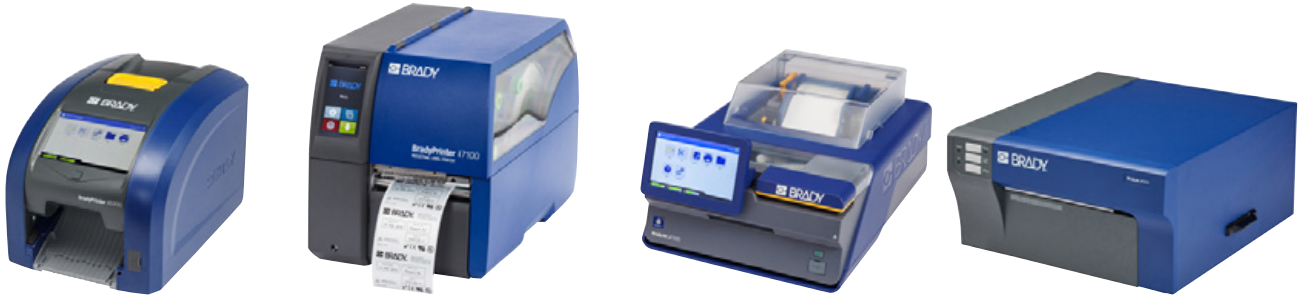

BradyPrinter i5300 Industrial Label Printer	BradyPrinter i7100 Industrial Label Printer	BradyJet J7300 Colour Label Printer	BradyJet J4000 Colour Label Printer
5000	7000	5000	5000
300 / 600	300 / 600	Up to 4800	Up to 4800
Thermal Transfer, Direct Thermal	Direct Thermal, Thermal Transfer	Inkjet	Inkjet
254.00 mm/s	300.00 mm/s	30.48 mm/s	114.30 mm/s
107.95 mm	109.98 mm	107.95 mm	203.20 mm
4 - 250 pt	–	Determined by software	–
101.98 mm	105.66 mm	107.95 mm	203.20 mm
Codabar, Code 128A, Code 128B, Code 128C, Code 39, Code 93, EAN-13, EAN-8, HIBC, Interleaved 2 of 5, JAN-8, JAN-8, MSI, Plessey, UPC-A, Aztec, Data Matrix, PDF417, QR code	Codabar, Codablock F, Code 128A, Code 128B, Code 128C, Code 39, Code 39 Full ASCII, Code 93, Deutsche Post Identcode, Deutsche Post Leitcode, EAN/UCC 128, EAN/UPC, EAN/UPC Extension 2, EAN/UPC Extension 5, EAN-13, EAN-8, FIM, GS1 DataBar, GS1 DataBar Limited, GS1 DataBar Stacked, GS1 DataBar Stacked Omnidirectional, GS1 DataBar Truncated, GS1-128, HIBC, Interleaved 2 of 5, JAN-8, MSI, Plessey, POSTNET, UPC-A, UPC-E, UPC-E0, Aztec, Data Matrix, GS1 DataMatrix, MaxiCode, MicroPDF417, PDF417, QR code	Through Brady Workstation and 3rd party software	Through Brady Workstation and 3rd party software
See Brady Workstation Software	See Brady Workstation Software	Dependant on software	Dependant on software
512 MB RAM, 195 MB IFFS Flash	256 MB RAM, 50 MB IFFS Flash, SD card up to 512 GB	32 GB, expandable through USB	–
Peripheral	Stand-alone & Peripheral	Peripheral	Peripheral
Monocolour	Monocolour	Full Colour	Full Colour
Cabled, Ethernet, USB 2.0, USB Host	Ethernet, I/O connection (optional), Bluetooth (optional), Wi-Fi (optional), Serial, USB	Ethernet, USB-C, Wi-Fi, USB Host	USB, Ethernet
None	None	None	None
Print head (300 dpi), Print head (600 dpi), Print roller	101.60 mm media adapter, Auto cutter, Cleaning swabs, Cutter perforator, Cutter with tray, Extended peel plate, I/O interface accessory, Narrow width print rollers, Peel off, Platen rollers, Present sensor, Rewinder, WLAN USB stick with antenna	Alignment roll, Cleaning kit, Ink cartridge, Power cord, Tray, USB cable	Ink cartridge
15.0 kg	10 kg	16.33 kg	16 kg
2 years	2 years	2 years	1 year





Learn more at [www.bradyeurope.com/M210-LAB](http://www.bradyeurope.com/M210-LAB)

## M210-LAB LABEL PRINTER

### MAXIMUM EFFICIENCY MEETS ENHANCED QUALITY

Now with pre-sized labels and even more materials to take on the toughest laboratory labelling jobs. With the M210 Label Printer smart automatic formatting, all you need to do is drop in a label cartridge, type and print.

▶ **Updated name. Elevated experience.**

Design, create and print independently via an intuitive keypad. Reuse and adapt locally saved labels, and create from scratch with on-board label design wizards.

▶ **Label it once.**

Now with both pre-sized and continuous labels in 90+ cartridges, filled to the brim with reliable, tested and dedicated label materials that stay attached and remain legible on every surface and in any environment.

▶ **Tough and easy going.**

Swiftly change cartridges with a drop-lock-print system in a lightweight, 0.7kg printer that can take a 1.8m fall and shocks without blinking.



### M210-LAB Label Printer

Article No.	Order Ref.	Description
152261	M210-LAB	M210-LAB Label Printer - Carton Pack

This printer ships in a carton pack with a Quick Start Guide and an M21-750-7425 label cartridge

### M210-LAB Starter Kits

Article No.	Order Ref.	Description
311319	M210-LAB-kit EU	M210 LAB Kit EU
311320	M210-LAB-kit UK	M210 LAB Kit UK
311321	M210-LAB-kit US	M210 LAB Kit US

This kit ships in hard case with a M210-Lab printer, a Li-ion Battery, a Power Cord, a Quick Start Guide and a M21-750-7425 Label Cartridge.

### Accessories

Article No.	Order Ref.	Description
110416	BMP21-AC EUR	AC Adaptor, Europe 220V
110417	BMP21-AC UK	AC Adaptor, UK 240V
170422	M210-AC	AC Adaptor, US 110V
170421	M210-HC	Hard Case for M210 and M210-LAB
170420	M210-BATTERY	Lithium-ion Battery Pack for M210 Label Printer
170385	M21-BELTCLIP	M210 and M211 Belt Clip
170425	M21-MAGNET	Magnet Only Accessory
170424	M210-TOOL	Multifunctional Accessory
150617	BMP-SC-1	Protective softbag for portable printers for M211; M210; BMP21; BMP51





Learn more at [www.bradyeurope.com/M211](http://www.bradyeurope.com/M211)



## M211 LABEL PRINTER

DESIGN. PREVIEW. PRINT. ALL FROM YOUR PHONE.

Design, preview and print – all from your phone. Simple and intuitive, the M211 Label Printer is built for the job site, running all day on a full charge while resisting drops, shocks and crushes.

▶ **Simple. Easy. Intuitive.**

Seamlessly design, preview and print labels from the industry leading Express Labels App on your familiar smartphone and swiftly connect to your printer.

▶ **Label it once.**

Now with both pre-sized and continuous labels in 90+ cartridges, filled to the brim with reliable, tested and dedicated label materials that stay attached and remain legible on every surface and in any environment.

▶ **Survives and thrives on any worksite.**

Ready to label all day with a lightweight, 0.5 kg printer, a powerful battery, drop-lock-print label cartridges and a built-in auto-cutter. Survives falls from up to 1.8m, 110 kg crushes, and shocks.



### M211 Label Printer

Article No.	Description
170381	M211 Printer - EMEA

This printer ships in a carton pack with M21-750-499 label cartridge, AC power cord with EU, UK and US plugs and Quick Start Guide.

### M211 Label Printer Kit

Article No.	Description
170390	M211 EMEA kit

This kit ships in a hard case with a M211 Printer, M21-750-499 Label Cartridge, Quick Start Guide, AC Power cord with EU, UK and US plugs, Belt Clip and Power Pack.

### Accessories

Article No.	Description
170385	M211 Belt Clip
170386	M211 Hard Case
170387	M211 Power Brick
170388	M211 AC Wall adapter EMEA
170425	M211 Magnet Only Accessory

▶ **Label creation, just a tap away.**

Go mobile and get more options with Express Labels.

[www.bradyeu/software/express-labels-mobile](http://www.bradyeu/software/express-labels-mobile)





Learn more at [bradyeurope.com/M511](https://bradyeurope.com/M511) or scan to watch the overview video.

## M511 LABEL PRINTER

### MORE INFORMATION. LESS WASTE.

Work the way you want. Create bigger messages. Go edge to edge. Design and print on the fly — from your laptop, tablet or smart phone. Bluetooth enabled, the M511 connects multiple users at the same time for far more efficient workflows. The workplace is changing. Work better with the M511.

#### Do more with these industry-leading features:

- ▶ 8+ hours/1,000 labels on a single charge
- ▶ Space-saving design
- ▶ Auto label cutter
- ▶ Bluetooth 5.0
- ▶ Resists 1.8 m drops, 115 kg crushes and has military-grade shock resistance
- ▶ Share label files in multiple locations
- ▶ 300 dpi resolution for 1D and 2D barcodes

#### REVOLUTIONISE THE WAY YOU WORK



**RESISTS 1.8 M DROPS AND 115 KG CRUSHES**



**CONNECT UP TO 5 DEVICES AT A TIME**



**DESIGN & PRINT WITH A PHONE OR PC**

### M511 Label Printer

Art. No.	Order Ref.	Description
176494	M511-EU-UK-KIT	M511 Label Printer Kit - EMEA
321673	M511-EU-UK-LAB	M511 Label Printer with Brady Workstation Lab Suite - EMEA

#### M511-EU-UK-LAB :

This printer ships in a carton box with M5C-1500-595-WT-BK label cartridge, AC Adapter with EU and UK plugs, Quick Start guide and a Brady Workstation Laboratory ID Software Suite.

#### M511-EU-UK-KIT :

This printer ships in a hard case with a M511 printer, M5C-1500-595-WT-BK, M4-91-427, M5-131-499 label cartridges, an AC Adapter, a magnet, a utility hook, a Power Brick for M211 and M511 printers, a Quick Start Guide and Brady Workstation Product and Wire ID Software Suite.

### Accessories

Art. No.	Order Ref.	Description
176448	M511-HC	M511 Hard Case
176449	M51-MAGNET	M511 Magnet
176450	M51-HOOK	M511 Utility Hook
176499	M211-M511-POWER	M511 and M211 Power Brick
176501	M211-M511-EU-UK-AC	M511 and M211 AC Adapter

### Mobile APP

Label creation made simple. That's the M511. Just grab a phone with the Express Labels app to design and print anytime, anywhere. Resize and edit labels, add graphics and QR codes — all using a familiar keyboard. It's intuitive. It's flexible. It's meant for modern workspaces.





Learn more at [www.bradyeurope.com/M510](http://www.bradyeurope.com/M510)

## M510 LABEL PRINTER

### POWERFUL PRECISION. ELEVATED EXPERIENCE.

The perfect companion for your project workspace, the M510 works fast to deliver high-quality labels day in and day out. Whether you're in a lab, field or facility, this printer works as hard as you do. Design and print up to 38.1 mm labels on demand with a QWERTY keypad or create labels in batches at the office with Brady Workstation software.

#### Get more with these time-saving features:

- ▶ 38 mm per second print speed
- ▶ Work all day on a single charge with the enhanced Gen3 Li-ION battery\*
- ▶ Import and store data files from a USB thumb drive
- ▶ 300 dpi for sharp print quality
- ▶ Design and print labels using the two keypads or desktop software
- ▶ Seamless cartridge changes
- ▶ Resistant to 1.2 m drops

\* Sold separately. Included in all M510 Printer Kits.

#### PUNCH IN DATA LIKE A PRO



CREATE LABELS UP TO 38 MM



EDGE-TO-EDGE PRINTING



DESIGN AND PRINT FROM THE KEYPADS OR A PC



### M510 printer

Art. No.	Order Ref.	Description
177181	M510-EU*	M510 Label Printer EU
322723	M510-EU-BWS**	M510 Label Printer EU + Brady Workstation Suite
322725	M510-UK*	M510 Label Printer UK
322727	M510-UK-BWS**	M510 Label Printer UK + Brady Workstation Suite

This M510 Printer ships in a cardboard box with a rechargeable NiMH Battery Pack, an AC Adapter, B-595 Vinyl Label Cartridge, a Quick start Guide, a USB Cable, a \*Brady Workstation Basic Design or a \*\*Brady Workstation Advanced Suite, a USB Flash Drive with Driver and User Manual.

### M510 printer kits

Art. No.	Order Ref.	Description
177185	M510-KIT-EU*	M510 Portable Label Printer Kit EU
322724	M510-KIT-EU-BWS**	M510 Portable Label Printer Kit EU + Brady Workstation Suite
322726	M510-KIT-UK*	M510 Portable Label Printer Kit UK
322728	M510-KIT-UK-BWS**	M510 Portable Label Printer Kit UK + Brady Workstation Suite

This M510 Printer ships in hard case with a rechargeable NiMH Battery Pack, a rechargeable Li-ion Battery Pack, an AC Adapter, B-595 Vinyl Label Cartridge, a Quick start Guide, a Magnet, a Utility Hook, a USB Cable, \*Brady Workstation Basic Design or a \*\*Brady Workstation Advanced Suite, a USB Flash Drive with Driver and User Manual.



#### BRADY WORKSTATION BASIC DESIGN

Includes fundamental apps and features to create labels.



#### BRADY WORKSTATION ADVANCED SUITE

Product & Wire Identification, Safety & Facility Identification, or Lab Identification, enabling easy creation of a wide range of labels and signs.

Art. No.	Order Ref.	Description
176990	M41-51-61-AC	AC Adapter for M410, M510, M511, M610 and M611 Portable Printers
322828	M41-51-61-AC-EU	AC Adapter EU for M410, M510, M511, M610 and M611 Portable Printers
322829	M41-51-61-AC-UK	AC Adapter UK for M410, M510, M511, M610 and M611 Portable Printers
176996	M510-HC	Hard Case for M510 Portable Printer
176450	M51-HOOK	M510-M511 Utility Hook
176449	M51-MAGNET	M510-M511 Magnet
175673	M-LION-BATTERY	Rechargeable Lithium-ion Battery for M510/M610/M710 printer
175674	M-NIMH-BATTERY	Rechargeable NiMH Battery for M510/M610/M710 printers





Learn more at [www.bradyeurope.com/M610](http://www.bradyeurope.com/M610)

## M610 LABEL PRINTER

### THE DURABILITY YOUR WORK DEMANDS

Save and store labels on board with the widest range of data entry options.

Get more with these time-saving features:

- ▶ 50.8mm per second print speed
- ▶ Enhanced Gen3 li-ion battery
- ▶ Store and import data files from USB-thumb drive
- ▶ Import and save files, lists and graphics
- ▶ Design and print labels using the keypad, the mobile app or the desktop software
- ▶ Prints text, barcodes, shapes and images



#### DO MORE WITH ENHANCED CAPABILITIES



1.8M DROP MILITARY STANDARD SHOCK RESISTANCE



PRINT 4,500 LABELS ON A FULL CHARGE



WIDER (-18° TO 46°C) OPERATING TEMP. RANGE

#### M610 Label printer

Article No.	Order Ref.	Description
317790	M610-QWERTY-UK	M610 Label Printer - QWERTY UK
317791	M610-QWERTY-UK-BT	M610 Label Printer - QWERTY UK with Bluetooth
317792	M610-AZERTY	M610 Label Printer - AZERTY
317793	M610-AZERTY-BT	M610 Label Printer - AZERTY with Bluetooth
317794	M610-US	M610 Label Printer - QWERTY US
317795	M610-QWERTZ-BT	M610 Label Printer - QWERTZ with Bluetooth
317796	M610-US-BT	M610 Label Printer - QWERTY US with Bluetooth
317797	M610-QWERTY-EU	M610 Label Printer - QWERTY EU
317798	M610-QWERTY-EU-BT	M610 Label Printer - QWERTY EU with Bluetooth
317799	M610-CYRILLIC-BT	M610 Label Printer - CYRILLIC with Bluetooth

#### M610 Accessories

Article No.	Order Reference	Description
018556	PCK-5	Printer cleaning kit
150618	BMP-SC-2	Protective softbag for portable printers
175671	M610-HC	Hard Case for M610 Label Printer
175672	M610-MAGNET	Magnet for M610 Label Printer
175673	M-LION-BATTERY	Rechargeable Lithium-ion Battery for M510/M610/M710 printer
175674	M-NIMH-BATTERY	Rechargeable NiMH Battery for M510/M610/M710 printers

The Basic Suite is included with every printer, all you need to do is download it. **Workstation.BradyID.com/Free**

- ▶ For more information about the Brady Workstation Software Suites, see page 73.



Learn more at [www.bradyeurope.com/M611](http://www.bradyeurope.com/M611)



## M611 LABEL PRINTER

### KEEP TRACK OF YOUR SAMPLE DATA

Get more flexibility in the field. Design. Preview. Print. Any way you choose. Store more than 1,000 labels on board, access files easier and print multiple ways – on demand. Modernise workflows: create labels in the lab and share to the field to print anywhere, anytime.

#### Get more with these time-saving features:

- ▶ 50.8mm per second print speed
- ▶ Share label files in multiple locations
- ▶ Store and import data files from USB-thumb drive
- ▶ 50.8mm print width
- ▶ Compact and lightweight
- ▶ Connect to computer using Wi-Fi or USB cable or use your smartphone and the Express Label App

#### MODERNISE WORKFLOWS IN MULTIPLE WAYS



CREATE LABELS IN THE LAB OR IN THE FIELD. SAVE FOR EASY SHARING



SHARE VIA EMAIL TO FIELD, PRINT RIGHT FROM THE PRINTER TOUCH SCREEN OR PHONE



CONNECT UP TO 5 DEVICES VIA BLUETOOTH, SAVE TIME & HASSLE LABELLING ON-SITE

#### Printers

Article No.	Order Ref.	Description
317844	M611-EU-BT-W	M611 Label Printer - EU
317836	M611-UK-BT-W	M611 Label Printer - UK
317843	M611-AM-BT-W	M611 Label Printer - US

\* This printer ships in a cardboard box holding a USB cable, a quick start guide, an AC powercord, a USB stick holding product info and Windows driver, a Brady Workstation Basic Design Suite, a roll of M6-11-427 and an M61-R4310 ribbon.

The Basic Suite is included with every printer, all you need to do is download it. [Workstation.BradylD.com/Free](http://Workstation.BradylD.com/Free)

- ▶ For more information about the Brady Workstation Software Suites, see page 73.

#### Kits

Article No.	Order Ref.	Description
317840	M611-EU-LABS	M611 Label Printer - EU with Brady Workstation LAB Suite
317841	M611-UK-LABS	M611 Label Printer - UK with Brady Workstation LAB Suite
317842	M611-US-LABS	M611 Label Printer - US with Brady Workstation LAB Suite

#### Accessories

Article No.	Order Ref.	Description
175603	M611-HC	Hard Case for M611 Label Printer
175604	M611-MAGNET	Magnet for M611 Label Printer
175605	M611-SLING	Sling Pack for M611 Printer

#### Mobile APP

Through data automation, you can seamlessly get your data on your label in a format you need. It's all in the powerful Brady Workstation Express Labels Mobile App that connects your data to label templates so you keep your data integrity without any extra work. When it's time to start creating labels, simply pull from your data file and get to work.





Learn more at [www.bradyeurope.com/M710](http://www.bradyeurope.com/M710)

## M710 LABEL PRINTER

### THE FASTEST, MOST ADVANCED PORTABLE YET.

The M710 label printer can print on more than 60 material options including several which are specifically suitable for a laboratory environment - all designed with Brady's industrial strength durability.

#### Get more with these time-saving features:

- ▶ 76mm per second print speed
- ▶ Prints 4,500 labels on one charge
- ▶ Withstands 1.2m drops, blowing sand and dust
- ▶ Use keypad, your smartphone and the Express Label App or the software to print labels
- ▶ Prints text, barcodes, shapes and images
- ▶ Label saving, sharing and data imports



#### GET MORE DONE WITH:



**LIGHTNING-FAST PRINT SPEEDS**



**SHOP-TO-FIELD FLEXIBILITY**



**MORE THAN 60 MATERIAL OPTIONS**

#### M710 Label Printer

Article No.	Order Ref.	Description
317814	M710-AZERTY-EU	M710 Label Printer AZERTY
317815	M710-WB-AZERTY-EU	M710 Label Printer AZERTY, Wi-Fi, BT
317817	M710-WB-CYRILLIC	M710 Label Printer Cyrillic with Wi-Fi and BT
317810	M710-QWERTY-EU	M710 Label Printer QWERTY EU
317811	M710-WB-QWERTY-EU	M710 Label Printer QWERTY EU with Wi-Fi and BT
317812	M710-QWERTY-UK	M710 Label Printer QWERTY UK
317813	M710-WB-QWERTY-UK	M710 Label Printer QWERTY UK with Wi-Fi and BT
317816	M710-WB-QWERTZ	M710 Label Printer QWERTZ with Wi-Fi and BT

This printer ships in a hard case holding a USB cable, a quick start guide, a product USB (with product info and Windows driver), a Li-ION Rechargeable Battery, an AC Adapter, a Brady Workstation Software, a Media Adapter, a roll of M7C-1000-595-WT and an M7-R6000 ribbon.

#### M710 Accessories

Article No.	Order Reference	Description
175664	M710-HC	Hard Case M710 Label Printer
175665	USB-C-A-CABLE	USB-C to USB Type A Cord
175673	M-LION-BATTERY	Rechargeable Lithium-ion Battery for M510/M610/M710 printer
175674	M-NIMH-BATTERY	Rechargeable NiMH Battery for M510/M610/M710 printers
114886	M71-CLEAN	Cleaning Kit
147998	M71-ADAPT-BK	Media Adaptor for high-end portable printer
150619	BMP-SC-3	Protective softbag for portable printers

The Basic Suite is included with every printer, all you need to do is download it. **Workstation.BradyID.com/Free**

- ▶ For more information about the Brady Workstation Software Suites, see page 73.





Learn more at [www.bradyeurope.com/BBP12](http://www.bradyeurope.com/BBP12)



## BBP12 LABEL PRINTER

The BBP12 Label Printer is an entry level benchtop label printer for laboratory sample identification that offers great value for money. The compact BBP12 offers a high print speed of 100 mm/second and can handle a wide range of highly durable and specialised Brady identification labels.

There are a dozen good reasons to choose the compact benchtop entry level BBP12 Label Printer:

- ▶ Prints a wide range of identification labels from 6 mm up to 112 mm wide
- ▶ Compact in size, fits on every desk
- ▶ Best price/quality in the market for low volume printing
- ▶ Standard 300 dpi print quality allowing accurate image & barcode positioning on small labels
- ▶ Full colour LCD Display and intuitive software interface are simple to use, so no extensive training is required
- ▶ Simple calibration menu with easy 1-2-3 step printing
- ▶ Default Ethernet Connectivity, allowing you to work in a network
- ▶ Connect any universal keyboard via USB 2.0 to work in stand-alone mode
- ▶ Print time and date on to your labels via the "Real time clock feature"
- ▶ With its powerful 32 bit processor and its extended memory it can print up to 100 mm / sec
- ▶ The printer supports the industry-standard Zebra® and Eltron® programming languages
- ▶ Comes with a free unwinder accessory to print larger label rolls

### BBP12 Label Printer

Article No.	Order Ref.	Description
306867	BBP12-EU-U-C-LABS	BBP12 Label printer 300 dpi - EU with Cutter, Unwinder and Brady Workstation LAB Suite
195966	BBP12-EU-U-CUTTER	BBP12 Label printer 300 dpi - EU with Cutter and Unwinder
195566	BBP12-EU-UNWINDER	BBP12 Label printer 300 dpi - EU with Unwinder
306866	BBP12-EU-U-LABS	BBP12 Label printer 300 dpi - EU with Unwinder and Brady Workstation LAB Suite
306869	BBP12-UK-U-C-LABS	BBP12 Label printer 300 dpi - UK with Cutter, Unwinder and Brady Workstation LAB Suite
195967	BBP12-UK-U-CUTTER	BBP12 Label printer 300 dpi - UK with Cutter and Unwinder
195567	BBP12-UK-UNWINDER	BBP12 Label printer 300 dpi - UK with Unwinder
306868	BBP12-UK-U-LABS	BBP12 Label printer 300 dpi - UK with Unwinder and Brady Workstation LAB Suite
306871	BBP12-US-U-C-LABS	BBP12 Label printer 300 dpi - US with Cutter, Unwinder and Brady Workstation LAB Suite
195968	BBP12-US-U-CUTTER	BBP12 Label printer 300 dpi - US with Cutter and Unwinder
195568	BBP12-US-UNWINDER	BBP12 Label printer 300 dpi - US with Unwinder
306870	BBP12-US-U-LABS	BBP12 Label printer 300 dpi - US with Unwinder and Brady Workstation LAB Suite



- ▶ The Basic Suite is included with every printer, all you need to do is download it. **Workstation.BradyID.com/Free**  
For more information about the Brady Workstation Software Suites, see page 73.

### BBP12 Printer kits

Article No.	Order Ref.	Description
198596	BBP12-LAB Kit-EU	BBP12 Label printer 300 dpi - Laboratory Kit - EU
198597	BBP12-LAB Kit-UK	BBP12 Label printer 300 dpi - Laboratory Kit - UK
198598	BBP12-LAB Kit-US	BBP12 Label printer 300 dpi - Laboratory Kit - US

This BBP12 label printer comes in a cardboard box. It ships with an unwinder, USB Cable, power cord, product CD, Quick Start Guide, Brady Workstation Laboratory ID Suite, THT-131-461-3, THT-156-492-3, THT-163-499-3, R7950 35mmx70m /O, R6400 65mmx70m / O, R4900 65mmx70m /O



While the BBP12 label printer primarily uses 25.40 mm core materials for low to medium volume printing, an unwinder is available should high volume printing be needed.

### Accessory

Article No.	Order Ref.	Description
361064	BBP12/BBP11-PLnPR	Peel and Present



Learn more at [www.bradyeurope.com/i3300](http://www.bradyeurope.com/i3300)

## BRADYPRIINTER i3300 INDUSTRIAL LABEL PRINTER

The BradyPrinter i3300 Industrial Label Printer is a completely hassle free, easy to use PC-based printer. It can print a full range of safety and facility labels and signs as well as die cut labels for laboratory identification.

### PRINT A HUGE RANGE OF LABELS & SIGNS

With the BradyPrinter i3300, you can print a huge range of reliable labels and signs at your location in monocolour. More than 50 different Brady label materials are compatible with the BradyPrinter i3300.

These can be used both in- and outdoor, and include specialty solutions like ToughWash labels and ToughStripe floor marking.

### EXTREMELY EASY TO USE

The BradyPrinter i3300 is extremely easy to use and features auto-calibration and automatic label material setup. This will enable you to immediately start printing the signs and labels you need. Switching to another label material is easy and extremely fast thanks to the printer's 'drop-in' label materials and matching ink ribbons that can be switched out in less than 20 seconds. When used with Brady Workstation apps, a wide variety of sign & label design options becomes available.



### Printer

Article No.	Order Ref.	Description
149553	i3300-300-C-EU	i3300 Industrial Label Printer- EU
241130	i3300-C-EU-LABS	i3300 Industrial Label Printer- EU with Brady Workstation LAB Suite
149555	i3300-300-C-UK	i3300 Industrial Label Printer- UK
241132	i3300-C-UK-LABS	i3300 Industrial Label Printer- UK with Brady Workstation LAB Suite
149551	i3300-300-C-US	i3300 Industrial Label Printer- US
241128	i3300-C-US-LABS	i3300 Industrial Label Printer- US with Brady Workstation LAB Suite
149554	i3300-300-C-EU-WF	i3300 Industrial Label Printer with Wifi- EU
241131	i3300-C-EU-W-LABS	i3300 Industrial Label Printer with Wi-Fi- EU with Brady Workstation LAB Suite
149556	i3300-300-C-UK-WF	i3300 Industrial Label Printer with Wi-Fi- UK
241133	i3300-C-UK-W-LABS	i3300 Industrial Label Printer with Wi-Fi- UK with Brady Workstation LAB Suite
149552	i3300-300-C-US-WF	i3300 Industrial Label Printer with Wi-Fi - US
241129	i3300-C-US-W-LABS	i3300 Industrial Label Printer with Wi-Fi- US with Brady Workstation LAB Suite

This i3300 printer comes in a cardboard box. It ships with a power cord, a Brady Workstation LAB Suite, a USB cable, a product CD holding the manual, a cleaning kit and a printed quick start guide

- ▶ The Basic Suite is included with every printer, all you need to do is download it. [Workstation.BradylD.com/Free](http://Workstation.BradylD.com/Free)  
For more information about the Brady Workstation Software Suites, see page 73.

### Accessories

Article No.	Order Ref.	Description
036612	Squeegee	Squeegee
120994	B30-TROLLEY	Trolley for S3100, i3300
133251	PCK-6	Printer Cleaning Kit, Thermal Transfer Printers
142114	B31-WIPER	Media Wiper 5 Pack
142116	B31-CCT	Cutter Cleaning Tool for BBP30, BBP31, BBP33, S3100, i3300, S3700

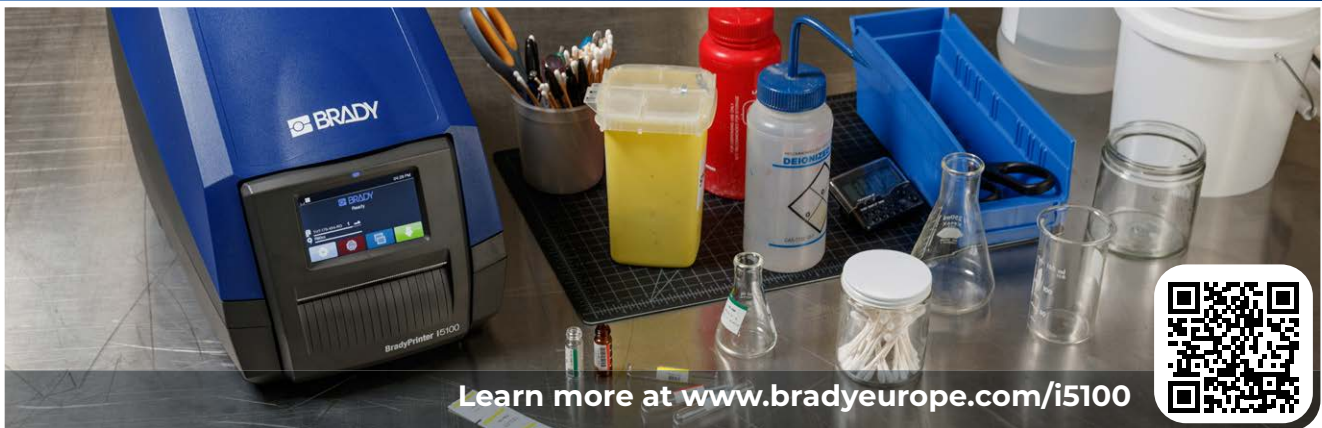

Learn more at [www.bradyeurope.com/i5100](http://www.bradyeurope.com/i5100)



## BRADYPRINTER i5100 INDUSTRIAL LABEL PRINTER

The BradyPrinter i5100 Industrial Label Printer is smart and easy to use, offers excellent performance and prints over 1200 standard identification labels plus user specific, tailored custom labels.

### SMART & CONNECTED

- Communicates automatically with our label design apps, label consumables and ink ribbons for a smooth and fast printer setup.
- Intuitive, full colour touch screen includes a label and print status monitor which also informs you when the installed ink ribbon does not optimally match the inserted label supplies.
- Brady labels can easily be loaded thanks to a self-centering roll holder and automatic calibration and label setup.
- The printer features a range of standard ports for common industrial connectivity scenarios.

### EXCELLENT PRINT PERFORMANCE

- With 300 and 600 dpi printing, the BradyPrinter i5100 offers crisp, high quality printing on reliable, industrial grade labels from 5 up to 110 mm.
- Driven by a powerful 32 bit and 800 Mhz internal printer processor, the i5100 prints at a speed of up to 300 mm/sec at 300 dpi.
- The printer's interchangeable platen rollers help to keep its performance at maximum, even after intensive use.



### RELIABLE, INDUSTRIAL GRADE LABELS

- The BradyPrinter i5100 can print on 70 label materials, more than 1200 stock label parts and tailored custom label materials and parts.
- Laboratory labels: cryo tube labels, slide labels, removable glassware labels, well plate labels, tissue cassette labels a.o.

## Printers

Article No.	Order Ref.	Description
149458	i5100-300-UKEU	BradyPrinter i5100 300 dpi - UK/EU
306872	i5100-300-EU-LABS	BradyPrinter i5100 300 dpi - UK/EU with Brady Workstation LAB Suite
149459	i5100-300-C-UKEU	BradyPrinter i5100 300 dpi - UK/EU with Cutter
306874	i5100-300C-EU-LABS	BradyPrinter i5100 300 dpi - UK/EU with Cutter and Brady Workstation LAB Suite
198766	i5100-300-US	BradyPrinter i5100 300 dpi - US
306873	i5100-300-US-LABS	BradyPrinter i5100 300 dpi - US with Brady Workstation LAB Suite
198767	i5100-300-C-US	BradyPrinter i5100 300 dpi - US with Cutter
306875	i5100-300C-US-LABS	BradyPrinter i5100 300 dpi - US with Cutter and Brady Workstation LAB Suite
149461	i5100-600-UKEU	BradyPrinter i5100 600 dpi - UK/EU
306876	i5100-600-EU-LABS	BradyPrinter i5100 600 dpi - UK/EU with Brady Workstation LAB Suite
149462	i5100-600-C-UKEU	BradyPrinter i5100 600 dpi - UK/EU with Cutter
306878	i5100-600C-EU-LABS	BradyPrinter i5100 600 dpi - UK/EU with Cutter and Brady Workstation LAB Suite
198768	i5100-600-US	BradyPrinter i5100 600 dpi - US
306877	i5100-600-US-LABS	BradyPrinter i5100 600 dpi - US with Brady Workstation LAB Suite
198769	i5100-600-C-US	BradyPrinter i5100 600 dpi - US with Cutter
306879	i5100-600C-US-LABS	BradyPrinter i5100 600 dpi - US with Cutter and Brady Workstation LAB Suite

This i5100 printer comes in a cardboard box. It ships with a power cord, a USB cable, a product CD holding the driver, the user manual in languages, the configuration/settings manual in English and a printed user manual in English, an RFID enabled roll holder, a ribbon take up spindle and a Brady Workstation Basic Suite

## Accessories

Article No.	Order Ref.	Description
133251	PCK-6	Printer Cleaning Kit, Thermal Transfer Printers
149080	BT-USB-ADAPT	Bluetooth USB Adapter
149131	WLAN-EXANT	USB Wlan Stick with External Antenna
149470	i5100-IP-HOLDER	i5100 Autodetect Label Roll Holder
149471	i5100-PR-120mm	i5100 120mm Platen Roller
149472	i5100-PR-25mm	i5100 25mm Platen Roller
149473	i5100-PR-50mm	i5100 50mm Platen Roller
149562	i5100-IP-RIBBTKUP	Ribbon Takeup Spindle
149598	i5100-PR-80mm	i5100 80mm Platen Roller
197823	SD-CARD-8GB	SD Memory card 8GB

- The Basic Suite is included with every printer, all you need to do is download it.

**Workstation.BradyID.com/Free**

For more information about the Brady Workstation Software Suites, see page 73.



Learn more at [www.bradyeurope.com/i5300](http://www.bradyeurope.com/i5300)

## BRADYPRINTER i5300 INDUSTRIAL LABEL PRINTER

Set up, switch out and print faster than you ever imagined with the BradyPrinter i5300 Industrial Label Printer. It's intuitive, auto-calibrating and precise, printing barcodes and small fonts on labels as small as 5.08 mm. With a solid, metal frame construction, it can handle both high-volume and high-mix labelling applications.

### Experience easy. No setup. No adjustments. No waste.

- ▶ 300 dpi; prints small fonts with precision
- ▶ Requires no calibration and no heat and speed setting adjustments
- ▶ 20-second material changeovers, 5.08 mm – 101.6 mm label widths
- ▶ Pauses, resumes and stores print jobs on printer in an adjustable queue with overwrite protection
- ▶ 178 mm colour touchscreen and built-in auto cutter
- ▶ Intuitive and easy to operate



When it comes to the BradyPrinter i5300 Industrial Label Printer, everything's easy. Taking just seconds to set up and load, it offers a faster, easier start-to-print process. That's because it's designed for efficiency - no setup, no adjustments and no waste. Zero. Enjoy time-saving features like a print queue and interrupt function. Plus, get precision printing on 75 material types and over 1300 parts, with custom parts available. All this so you can reach your high-mix, high-volume printing goals. Ready? We told you it was easy.

### Printer

Article No.	Order Ref.	Description
151274	I5300-C-EU	BradyPrinter i5300 - EU
310339	I5300-C-EU-LAB	BradyPrinter i5300 - EU with Brady Workstation LAB Suite
151275	I5300-C-EU-WF	BradyPrinter i5300 with Wi-Fi - EU
310340	I5300-C-EU-WF-LAB	BradyPrinter i5300 with Wi-Fi - EU with Brady Workstation LAB Suite
151272	I5300-C-NA	BradyPrinter i5300 - NA
310351	I5300-C-NA-LAB	BradyPrinter i5300 - NA with Brady Workstation LAB Suite
151273	I5300-C-NA-WF	BradyPrinter i5300 with Wi-Fi - NA
310352	I5300-C-NA-WF-LAB	BradyPrinter i5300 with Wi-Fi - NA with Brady Workstation LAB Suite
151276	I5300-C-UK	BradyPrinter i5300 - UK
310345	I5300-C-UK-LAB	BradyPrinter i5300 - UK with Brady Workstation LAB Suite
151277	I5300-C-UK-WF	BradyPrinter i5300 with Wi-Fi - UK
310346	I5300-C-UK-WF-LAB	BradyPrinter i5300 with Wi-Fi - UK with Brady Workstation LAB Suite

This i5300 Industrial Label Printer comes in a cardboard box. It ships with a Brady WorkStation Basic Design Suite, a Power Cable, a USB Cable, a Stylus, a cleaning kit, a QuickStart Guide, a Jump drive with How To Videos and 3rd Party Win Driver.

▶ The Basic Suite is included with every printer, all you need to do is download it. [Workstation.BradyID.com/Free](http://Workstation.BradyID.com/Free)

For more information about the Brady Workstation Software Suites, see page 73.

### Accessories

Article No.	Order Ref.	Description
148703	MEDIA WIPER, BBP35-37, i5300	BBP35 and BBP37 Media Wiper
153661	I5300-PH-300D	i5300 Print Head 300 dpi
153663	I5300-PR-115MM	i5300 Print Roller
133251	PCK-6	Printer Cleaning Kit, Thermal Transfer Printers
142115	ASSY, PKG, ACCESSORY, STYLUS, PLA	Replacement Stylus 3 Pack



Learn more at [www.bradyeurope.com/i7100](http://www.bradyeurope.com/i7100)



## BRADYPRINTER i7100 INDUSTRIAL LABEL PRINTER

The BradyPrinter i7100 Industrial label printer offers durable and highly accurate label printing for business critical high volume identification challenges in laboratories. Quickly print a wide range of high quality identification materials for a variety of laboratory applications.

### RELIABLE & FAST PRECISION PRINTING

- ▶ A powerful internal processor designed to handle up to 7000 labels per day
- ▶ Up to 300 mm/sec print speed
- ▶ 600 dpi ultra-sharp printing
- ▶ Centre alignment of prints for high printing accuracy
- ▶ Interchangeable platen rollers for optimised printhead life time
- ▶ A wide range of high quality identification materials

### EASY TO USE

The BradyPrinter i7100 has an intuitive colour touch screen interface with distinctive icons to easily access the printer's menus. The printer's foldable cover allows for a small system footprint and enables users to quickly change consumables to start a new job or continue printing.



### BradyPrinter i7100

Art. No.	Order Reference	Description
<b>300 dpi</b>		
149046	i7100-300-EU	BradyPrinter i7100 300 dpi - EU
306880	i7100-300-EU-LABS	BradyPrinter i7100 300 dpi - EU + Brady Workstation LAB Suite
149049	i7100-300-P-EU	BradyPrinter i7100 300 dpi - EU + Peel function
306883	i7100-300P-EU-LABS	BradyPrinter i7100 300 dpi - EU + Peel function & Brady Workstation LAB Suite
149067	i7100-300-UK	BradyPrinter i7100 300 dpi - UK
306881	i7100-300-UK-LABS	BradyPrinter i7100 300 dpi - UK + Brady Workstation LAB Suite
149068	i7100-300-P-UK	BradyPrinter i7100 300 dpi - UK + Peel function
306884	i7100-300P-UK-LABS	BradyPrinter i7100 300 dpi - UK + Peel function & Brady Workstation LAB Suite
197690	i7100-300-US	BradyPrinter i7100 300 dpi - US
306882	i7100-300-US-LABS	BradyPrinter i7100 300 dpi - US + Brady Workstation LAB Suite
197689	i7100-300-P-US	BradyPrinter i7100 300 dpi - US + Peel function
306885	i7100-300P-US-LABS	BradyPrinter i7100 300 dpi - US + Peel function & Brady Workstation LAB Suite
<b>600 dpi</b>		
149047	i7100-600-EU	BradyPrinter i7100 600 dpi - EU
306886	i7100-600-EU-LABS	BradyPrinter i7100 600 dpi - EU + Brady Workstation LAB Suite
149052	i7100-600-P-EU	BradyPrinter i7100 600 dpi - EU + Peel function
306889	i7100-600P-EU-LABS	BradyPrinter i7100 600 dpi - EU + Peel function & Brady Workstation LAB Suite
149066	i7100-600-UK	BradyPrinter i7100 600 dpi - UK
306887	i7100-600-UK-LABS	BradyPrinter i7100 600 dpi - UK + Brady Workstation LAB Suite
149065	i7100-600-P-UK	BradyPrinter i7100 600 dpi - UK + Peel function
306890	i7100-600P-UK-LABS	BradyPrinter i7100 600 dpi - UK + Peel function & Brady Workstation LAB Suite
197692	i7100-600-US	BradyPrinter i7100 600 dpi - US
306888	i7100-600-US-LABS	BradyPrinter i7100 600 dpi - US + Brady Workstation LAB Suite
197691	i7100-600-P-US	BradyPrinter i7100 600 dpi - US + Peel function
306891	i7100-600P-US-LABS	BradyPrinter i7100 600 dpi - US + Peel function + Brady Workstation LAB Suite

▶ The Basic Suite is included with every printer, all you need to do is download it. [Workstation.BradyID.com/Free](http://Workstation.BradyID.com/Free)

For more information about the Brady Workstation Software Suites, see page 73.



## VIAL LABEL APPLICATOR

### LABEL VIAL TUBES IN A FEW SECONDS

Automate vial tube identification to increase the output of your laboratory. When linked to our BradyPrinter i7100, the Vial Label Applicator prints and applies labels on vial tubes in a few seconds and enables scientists to spend more time on core responsibilities.

#### BradyPrinter i7100 + Vial Label Applicator

Art. No.	Order Reference	Description
307652	I7100-300-P-EU-VLA	BradyPrinter i7100 300 dpi - EU with Peel function and vial label applicator
307658	I7100300P-EULABVLA	BradyPrinter i7100 300 dpi - EU with Peel function and vial label applicator and Brady Workstation LAB Suite
307654	I7100-300-P-UK-VLA	BradyPrinter i7100 300 dpi - UK with Peel function and vial label applicator
307660	I7100300P-UKLABVLA	BradyPrinter i7100 300 dpi - UK with Peel function and vial label applicator and Brady Workstation LAB Suite
307656	I7100-300-P-US-VLA	BradyPrinter i7100 300 dpi - US with Peel function and vial label applicator
307662	I7100300P-USLABVLA	BradyPrinter i7100 300 dpi - US with Peel function and vial label applicator and Brady Workstation LAB Suite
307653	I7100-600-P-EU-VLA	BradyPrinter i7100 600 dpi - EU with Peel function and vial label applicator
307659	I7100600P-EULABVLA	BradyPrinter i7100 600 dpi - EU with Peel function and vial label applicator and Brady Workstation LAB Suite
307655	I7100-600-P-UK-VLA	BradyPrinter i7100 600 dpi - UK with Peel function and vial label applicator
307661	I7100600P-UKLABVLA	BradyPrinter i7100 600 dpi - UK with Peel function and vial label applicator and Brady Workstation LAB Suite
307657	I7100-600-P-US-VLA	BradyPrinter i7100 600 dpi - US with Peel function and vial label applicator
307663	I7100600P-USLABVLA	BradyPrinter i7100 600 dpi - US with Peel function and vial label applicator and Brady Workstation LAB Suite
151156	i7100-VLA	i7100 Vial Label Applicator

#### BradyPrinter i7100 accessories

Art. No.	Order Reference	Description
133251	PCK-6	Printer Cleaning Kit, Thermal Transfer Printers
149043	i7100-PR-120mm	120mm Platen Roller with synthetic rubber coating
149044	i7100-PRS-120mm	120mm Platen Roller with silicone rubber coating
149048	i7100-PR-25mm	25mm Platen Roller with synthetic rubber coating
149051	i7100-RAR-120mm	120mm Rewind Assist Roller with synthetic rubber coating
149054	i7100-PR-80mm	80mm Platen Roller with synthetic rubber coating
149055	i7100-PR-50mm	50mm Platen Roller with synthetic rubber coating
149069	I7100-CUTTER-TRAY	i7100 Rotary Cutter with Tray
149070	i7100-ANTI-S-BRUSH	Antistatic Brush
149071	i7100-IO-LABEL-BOX	Label Selection I/O Box
149072	i7100-PS1000MP	i7100 Present Sensor PS1000MP
149073	i7100-IO-CONNECTOR	I/O Interface Connector SUB-D 25pins
149074	i7100-RG400-PLATE	Rewind Guide Plate RG400
149075	i7100-PS900	Present Sensor PS900
149077	i7100-IO-INTERFACE	I/O Interface
149078	i7100-PERF-CUTTER	i7100 Rotary Perforation Cutter
149080	BT-USB-ADAPT	Bluetooth USB Adapter
149131	WLAN-EXANT	USB Wlan Stick with External Antenna
149132	i7100-ADAPTER-100	i7100 Adapter for 100mm Core
149135	i7100-PPLTEXT-410	i7100 Extended Peel off plate DP410
149207	i7100-TEAR-OFF	i7100 Tear off Plate
149208	i7100-HEX-KEY-TOOL	i7100 Spare Hex Key Tool
151149	i7100-i5100-EXDISP	External display for i7100, i5100 & A8500
151150	EXDISP-USB-1.8M	USB cable for external display, 1,8m
151151	EXDISP-USB-3M	USB cable for external display, 3m
151152	EXDISP-USB-5M	USB cable for external display, 5m
151156	i7100-VLA	i7100 Vial Label Applicator
197823	SD-CARD-8GB	SD Memory card 8GB
302741	MC11 EUR	MC-11 Powered Label Rewinder for Europe
302744	LD100RS EUR	LD-100-RS Automatic Label Dispenser for Europe
302979	MC11 UK	MC-11 Powered Label Rewinder for United Kingdom
302980	LD100RS UK	LD-100-RS Automatic Label Dispenser for United Kingdom

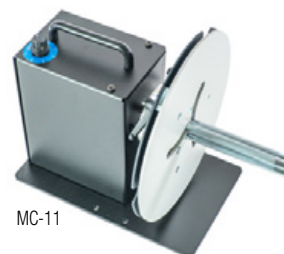
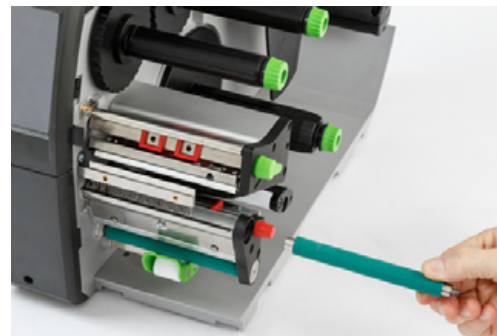

MC-11



LD-100-RS



Learn more at [www.bradyeurope.com/J7300](http://www.bradyeurope.com/J7300)



## BRADYJET™ J7300 COLOUR LABEL PRINTER

### UNLEASH YOUR TRUE COLOURS

Pivot through a demanding print queue with the BradyJet™ J7300 Colour Label Printer. Make an impact with vibrant full colour. Print on industrial-strength labels. And say goodbye to time-wasting setup thanks to built-in LabelSense™ print technology. Any colour, any information - do exactly what the job demands from the production line to the lab with the J7300.

Do exactly what the job demands with these advanced features:

- ▶ Minimal material changeovers and streamlined inventory
- ▶ Compliance-driving pictograms and templates for ISO, CLP/GHS, IMO and more
- ▶ Full-colour graphics, photos and logos
- ▶ Smear-free instant-drying ink
- ▶ Industrial-grade construction and quiet operation
- ▶ Purpose-built labels last years
- ▶ USB, Wi-Fi or ethernet connectivity
- ▶ Label creation software included plus Windows® driver for third party

### BRILLIANT COLOURS

### SMART OPERATION



#### AUTO SETUP

No threading needed, auto calibrates and prints on the first label.



#### FAST FLEXIBILITY

Intuitive software lets you create and print any colour, any information, anytime.



#### INSTANT ANALYTICS

Label and ink level alerts, cost calculator and remote monitoring.

### BradyJet J7300 printers

Article No.	Order Ref.	Description
176883	J7300-EU*	BradyJet™ J7300 Colour Label Printer EU
176884	J7300-W-EU*	BradyJet™ J7300 Colour Label Printer, Wi-Fi, EU
322658	J7300-UK*	BradyJet™ J7300 Colour Label Printer UK
322659	J7300-W-UK*	BradyJet™ J7300 Colour Label Printer, Wi-Fi, UK
322660	J7300-EU-BWS**	BradyJet™ J7300 Colour Label Printer EU + Brady Workstation Suite
322661	J7300-UK-BWS**	BradyJet™ J7300 Colour Label Printer UK + Brady Workstation Suite
322666	J7300-W-EU-BWS**	BradyJet™ J7300 Colour Label Printer, Wi-Fi, EU + Brady Workstation Suite
322667	J7300-W-UK-BWS**	BradyJet™ J7300 Colour Label Printer, Wi-Fi, UK + Brady Workstation Suite

This BradyJet J7300 Printer ships in a cardboard box with a CMY Ink Cartridge with built in Printhead, a Black Ink cartridge with built in Printhead, a J-Align roll, a media starter B-2595 Vinyl roll, an AC Adapter, a Power Cord, a USB cable, a USB Flash Drive with product information and a \*Brady Workstation Basic Design or a \*\*Brady Workstation Advanced Suite.



### Inks

Article No.	Order Ref.	Description
176504	P-CMY-1	CMY Ink Cartridge for BradyJet™ J7300 Colour Label Printer
176505	P-K-1	K True Black Ink Cartridge for BradyJet™ J7300 Colour Label Printer
177431	P-1CMY2K	Ink Multipack for BradyJet™ J7300 Colour Label Printer (1x CMY, 2x K)
177432	P-2CMY1K	Ink Multipack for BradyJet™ J7300 Colour Label Printer (2x CMY, 1x K)



**BRADY  
WORKSTATION  
BASIC DESIGN**

Includes fundamental apps and features to create labels.



**BRADY  
WORKSTATION  
ADVANCED SUITE**

Product & Wire Identification, Safety & Facility Identification, or Lab Identification, enabling easy creation of a wide range of labels and signs.



## BRADYJET J4000 COLOUR LABEL PRINTER

### HIGH IMPACT, PRECISION FULL COLOUR THAT LASTS

Create a safer, more efficient workplace with compliant, photo-quality full-colour labels, signs and procedures that last. Balance the complexity of safety and compliance labels with the demands of an industrial environment while reducing your safety signage inventory and material waste.

**Create compliant labels and signs:** Trust your regulatory and technical standard driven labelling offers the colours needed for ISO, CLP/GHS, ANSI, BS5609 and arc flash

**Extend label performance:** Rely on specially formulated materials and ink designed to stand up to harsh environments

**Maximise impact, improve efficiency and reduce waste:** Stock and print only what you need, when you need it, in photo-quality full-colour every time

### Printers

Article No.	Order Ref.	Description
152710	J4000-US	BradyJet J4000 Colour Label Printer
152711	J4000-EU	BradyJet J4000 Colour Label Printer
152712	J4000-UK	BradyJet J4000 Colour Label Printer
310390	J4000-EU-BWSLABS	BradyJet J4000 Colour Label Printer with Laboratory Software
310393	J4000-UK-BWSLABS	BradyJet J4000 Colour Label Printer with Laboratory Software
310444	J4000-US-BWSLABS	BradyJet J4000 Colour Label Printer with Laboratory Software
310388	J4000-EU-BWSSFID	BradyJet J4000 Colour Label Printer with Safety and Facility ID Software
310391	J4000-UK-BWSSFID	BradyJet J4000 Colour Label Printer with Safety and Facility ID Software
310442	J4000-US-BWSSFID	BradyJet J4000 Colour Label Printer with Safety and Facility ID Software

▶ The Basic Suite is included with every printer, all you need to do is download it. **Workstation.BradyID.com/Free**  
For more information about the Brady Workstation Software Suites, see page 73.

### Ink and storage caps

Article No.	Order Ref.	Description
152714	J40-CMY	BradyJet J4000 Full Colour Ink Cartridge
152713	J40-CAP	J4000 Ink Cartridge Storage Caps



# Label Creation Software

## Brady Workstation software suites

Brady Workstation offers professional, intuitive apps to design quality labels and safety signs. Label design becomes easier, faster and quickly adaptable to new label norms thanks to centralised updates.

### Select the apps you need

Simply select the apps you need, download the 30-day trial and purchase when satisfied.



### Brady Workstation Laboratory Identification Suite

Ensure labels for all your lab samples and equipment are crisp, clear and contain all necessary information. Easily design and create labels for your cryovials, centrifuge tubes, bottles, conicals, slides and other samples in your laboratory on this desktop software.

Article No.	Order Reference	Description
150498	BWS-LABS-EM	Brady Workstation Laboratory Suite as electronic media



### Brady Workstation Basic Design Software Suite

Get everyone in your facility up and running quickly on as many computers as you like with this free label creation software! You'll have basic design, formatting, graphics and simple barcode libraries to create labels like a pro!

The Basic Suite is included with every printer, all you need to do is download it. **Workstation.BradyID.com/Free**

**Try it today!**  
Discover Brady Workstation at [www.bradyeurope.com/workstation](http://www.bradyeurope.com/workstation) or download at [workstation.bradyid.com](http://workstation.bradyid.com).



### Brady Workstation Safety and Facility Identification Software Suite

Keep your facility safe and compliant by creating custom signs, label and pipemarkers, adding visual safety guidance. **Workstation.BradyID.com/SafetyAndFacility**



### Brady Workstation Data Automation

Use the Brady Workstation Data Automation app to set up automated sample label printing using information from a LIMS. Data Automation uses Brady Workstation label templates and .csv – exports from an ERP system such as LIMS. It enables the setup of several print channels that send preselected information to a predetermined label template which can be printed on a printer of choice, loaded with the correct consumables. Once set up, Data Automation can automatically print a sample label when a LIMS receives information on a newly arrived sample.



### Brady Workstation Express Labels Mobile App

The Brady Workstation Express Labels Mobile App makes mobile printing convenient and simple. This intuitively designed software integrates touchscreen technology for fast and easy label creation, including label resizing using touch and a native keyboard for more natural typing. To make label creation even more convenient, the app features auto-save capabilities, tools to help you easily enter data onto your label, and easy-to-use editing tools to keep labelling projects moving smoothly.

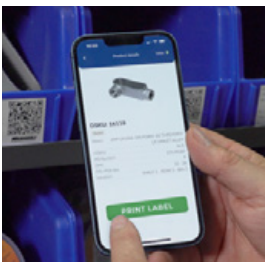

## Add label printing to your own app

Get next-level labelling capabilities - all from your own mobile app. Use our software development kit to equip your app with the printing power of Brady's Bluetooth-enabled printers: the M211, M511 and M611.

**Scan or click to see how Brady can help**



## CodeSoft™ Label Creation Software

CodeSoft is a very powerful, feature-rich design software. It has the most text editing and bar code features, plus it is the best choice for advanced database importation and integration with 3rd party software programs - like LIMS.

- Over 100 Bar code symbologies including linear and 2D
- Robust data sourcing capabilities
- View labels and data in the same screen
- Label Comparison tool for previewing labels at design or production stages
- OLE automation supports object integration from any 3rd party Windows® application
- Enhanced Shape Tool makes using graphics and shapes on your labels a snap
- **CodeSoft Pro** - is for users printing text, images and bar codes on one to three printers
- **CodeSoft Enterprise** - is for user printing from databases and existing systems
- **CodeSoft Network** - is for users who want to manage licenses from a server

## Barcode readers for Laboratories



**BRADY IS PROUD TO PRESENT THE CODE® BARCODE READERS AS ITS GOLD STANDARD FOR BARCODE SCANNING.**

### Scan everything that comes your way

- ▶ Imagine being able to scan all barcodes – small, large, far, near, damaged, reflective, a.o.
- ▶ Give your team the best solution for quick and accurate scanning – no matter the circumstances.
- ▶ Code's patented Dual-Field Optics allow faster scanning of barcodes in all sizes.
- ▶ Code scanners also excel at reading damaged codes and codes that are partially obscured by reflections or other lighting challenges.
- ▶ Dual-Field Optics technology supports your team's workflow. Team members will be able to focus on core tasks without wasting time with frequent scan position adjustments.

### Your data where you need it

Need to adapt your decoded data to integrate with your current systems? ScanFlex JS is a JavaScript application programming interface (API) for many Code scanners that enables any user to:

- ▶ read and manipulate data in the scanner memory
- ▶ access data sent by host
- ▶ transmit data to a host computer

### No need to choose between reliability and speed

Near Zero Miss (99.9995%) accuracy has already brought thousands of businesses in many countries the reliability and speed they need to keep their work flowing. With industry-leading scan accuracy, our Near Zero Miss- readers outscan the competition, both in tests and in real-world performance.

## Scan barcodes at lightspeed with the Code® barcode readers!

- Reliable scanning in the most challenging environments
- Easy integration of decoded data in your current systems
- Scanning at lightspeed with maximum accuracy

▶ [Visit our website for more information!](#)





## CODE READER™ 2700

### Get better visibility throughout your facility

The plug-and-play scanning you need to get the job done right

#### Battery life lasts a whole shift, and then some

- High-speed, omnidirectional reading of 1D and 2D barcodes
- Inductive charging eliminates contact failure caused by disinfectants
- Keeps dust and liquid out with superior IP65 case
- Visual, audible and haptic feedback (can be tailored to workflow needs)
- Adapts to your workflows with multiple programmable buttons
- QuickConnect to host PC via base station, dongle or DirectConnect
- Get full control of scanner and data with powerful JavaScript platform
- Store data for later offload in batch mode
- Enhance data security and extend battery life with Bluetooth® 5 Low Energy
- Proactive management with smart battery with built-in power gauge
- Compatible with Android, iOS and Windows (via USB or Bluetooth)
- PVC-free CodeShield® plastics stand up to harsh chemicals

#### FEATURES AT A GLANCE

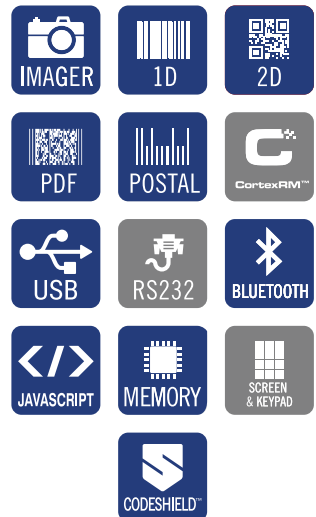

#### Reader options

Article No.	Description
176685	CR2700 Palm Barcode Reader with Charging Station
176686	CR2700 Palm Barcode Reader
176687	CR2700 Handled Barcode Reader with Charging Station
176688	CR2700 Handled Barcode Reader

#### Accessories

Article No.	Description
176689	CR2700 Inductive Charging Station with 1.8m USB Cable
176691	CR2700 Inductive Charging Station with 90cm USB Cable
176521	Code Reader™ 2700 Inductive Charging Station Wall Mount
176690	CR2700 Inductive Charging Station Base Mount
176508	USB to Micro USB 1.8 m Cable for Code Reader Barcode Scanner
176513	Code Reader™ 2700 Bluetooth Dongle
176694	CR2700 Battery





## CODE READER™ 1500

**Get scanning — right away.  
Simple. Easy. Intuitive.**

Seamless integration with the most trusted scanning tool around.

**Simplify your most complex data editing requirements**

- Patented dual-field optics scan more types of barcodes than any other reader
- IP54 rating seals out dust and moisture
- Lightweight and compact
- Visual, audible and haptic indicators customisable for workflow needs
- Powerful JavaScript platform for complete device control
- PVC-Free CodeShield® plastics stand up to more disinfectants

### FEATURES AT A GLANCE



### Reader options

Article No.	Description
176683	CR1500 Barcode Reader with Stand
176684	CR1500 Barcode Reader

### Accessories

Article No.	Description
176506	USB to RJ45 1.8 m Cable for Code Reader Barcode Scanner



## CODE READER™ 1100

### Automate your operations with accuracy

A critical component of your intelligent ecosystem

**Consumer-grade functionality. Industrial-grade durability.  
No wake time. No down time. No kidding.**

- Patented dual-field optics scan more types of barcodes than any other reader
- IP54 rating seals out dust and moisture
- Lightweight and compact
- Visual, audible, and haptic indicators customizable for workflow needs
- Powerful JavaScript platform for complete device control
- Disinfectant-ready housing

#### FEATURES AT A GLANCE



#### Reader options

Article No.	Description
176692	CR1100 Barcode Reader
176693	CR1100 Barcode Reader with stand

#### Accessories

Article No.	Description
176506	USB to RJ45 1.8 m Cable for Code Reader Barcode Scanner





## CODE READER™ 5200

**Read barcodes in any orientation.  
Hands-free operation.**

Small but mighty. Powerful scanning performance.

**Expedite workflows for greater operational efficiency.**

- High-speed, omnidirectional reading of 1D and 2D barcode symbologies
- Presentation reader with easy hands-free operation and enhanced motion detection
- Compact footprint with adjustable reading direction
- Quickly reads barcodes on mobile device screens
- User feedback with LED and audible tone
- Data parsing/formatting eases system compatibility
- Customizable driver license formatting lets users target specific information to populate fields on loyalty forms, credit card applications, and more
- Extended read ranges
- Efficient power consumption

### FEATURES AT A GLANCE



### Reader options

Article No.	Description
176695	CR5200 Barcode Reader
176696	CR5200 Barcode Reader with Age Verification

### Accessories

Article No.	Description
176506	USB to RJ45 1.8 m Cable for Code Reader Barcode Scanner



## Miscellaneous Products

80 Hazardous Substance Identification

83 Sorbent Products



# Hazardous Substance Identification



## Pre-Printed Labels with CLP/GHS Symbols

Brady has a wide range of pre-printed labels to identify your chemical containers.

- High quality labels that can withstand the toughest environments
- Ultra-durable materials mean you only need to label products once in their lifetime
- Extremely weather, abrasion and chemical resistant
- Labels can withstand temperatures of -40 °C to +120 °C

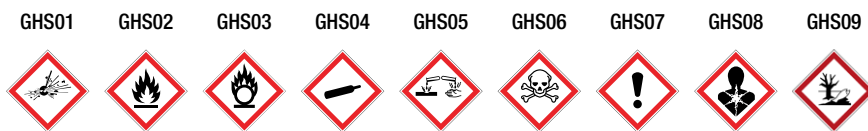

Width x Height (mm)	Layout	GHS01	GHS02	GHS03	GHS04	GHS05	GHS06	GHS07	GHS08	GHS09
		PIC 1801	PIC 1802	PIC 1803	PIC 1804	PIC 1808	PIC 1809	PIC 1805	PIC 1807	PIC 1806
		Explosive	Flammable	Oxidizing	Compressed Gas	Corrosive	Acute Toxicity	Health Hazard	Respiratory Hazard	Hazardous to Aquatic Environment
50 x 50	Continuous Roll	811681	811686	811691	811696	811716	811721	811701	811711	811706
50 x 50	Individual Markers on a Roll	814032	814033	814034	814035	814039	814040	814036	814038	814037
100 x 100	Continuous Roll	814023	814024	814025	814026	814030	814031	814027	814029	814028
100 x 100	Individual Markers on a Roll	811679	811684	811689	811694	811714	811719	811699	811709	811704

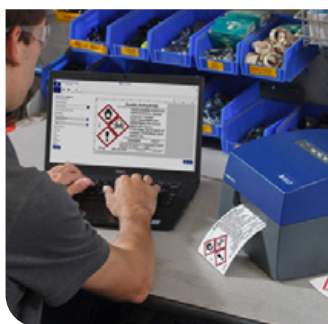

## Quickly print GHS/CLP-labels

The BradyJet J4000 and BradyJet J7300 colour label printers take printing reliable GHS/CLP labels at your location to a new level. The printers' advanced full colour inkjet technology can quickly turn a range of blank label materials and label sizes into compliant GHS/CLP labels to identify chemicals. With their automatic label setup technology, these printers can start printing on a new label size within seconds, saving you time, stress and hassle.

## Extremely reliable

Brady proposes B-7425J polypropylene and B-2595 vinyl label materials to print GHS/CLP labels. Both label materials remain legible and stay attached when exposed to chemicals.

## BradyJet J7300 labels

Diagram	Order Reference	Art. No.	Colour	Label Width A (mm)	Label Height B (mm)	Label Length B (m)	Total Qty/ Pack
<b>Inkjet Receptive Polypropylene</b>							
	JC-1125-7425J	176584	White	28.58	-	45.72 m	1
	JC-2250-7425J	176585	White	57.15	-	45.72 m	1
	J-18-7425J	176615	White	76.20	25.40	-	1000
	J-260-7425J	176614	White	55.12	85.09	-	500
	J-261-7425J	176617	White	74.93	109.98	-	300
	J-262-7425J	176618	White	104.90	154.94	-	250
<b>Inkjet Receptive Vinyl</b>							
	JC-1125-2595	176580	White	28.58	-	45.72 m	1
	JC-2250-2595	176581	White	57.15	-	45.72 m	1
	JC-4000-2595	170458	White	101.60	-	45.72 m	1
	J-18-2595	176602	White	76.20	25.40	-	1000
	J-260-2595	176601	White	55.12	85.09	-	500
	J-261-2595	176603	White	74.93	109.98	-	300
	J-262-2595	176604	White	104.90	154.94	-	250

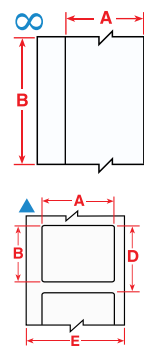

## BradyJet J4000 labels

Diagram	Order Reference	Art. No.	Colour	Label Width A (mm)	Label Height B (mm)	Label Length B (m)	Total Qty/ Pack
<b>Inkjet Receptive Polypropylene</b>							
	J40C-2250-7425J	152783	White	57.15	-	30.48 m	1
	J40C-4000-7425J	152784	White	101.60	-	30.48 m	1
	J40C-6000-7425J	152785	White	152.40	-	30.48 m	1
	J40C-8000-7425J	152786	White	203.20	-	30.48 m	1
	J40-260-7425J	152778	White	55.12	85.09	-	340
	J40-321-2475J	152781	White	203.20	133.35	-	100
	J40-262-7425J	152779	White	104.90	154.94	-	200
	J40-265-7425J	152780	White	177.80	254.00	-	100
	J40-268-2475J	152782	White	203.20	279.40	-	100

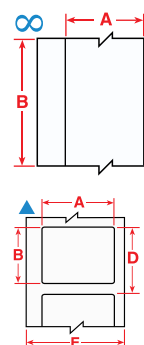



# Hazardous Substance Identification

## Pre-printed GHS/CLP Chemical Labels

Print 2 colour GHS labels in one fast print pass!

- Blank labels with pre-printed red diamonds allow printer to produce 2 colour GHS/CLP labels in one print pass
- 3 sizes of labels, each with 6 different diamond layouts that match templates in Brady Workstation.
- Indoor/outdoor vinyl resists moisture, chemicals and handling



### Pre-printed GHS/CLP Labels for BBP12 Label Printer

Diagram	Order Reference	Layout	Label Width A (mm)	Label Height B (mm)	Vertical Repeat D (mm)	Web Width E (mm)	Labels per Row	Labels per Package	Ribbon Series
<b>B-7610: Paper</b>									
▲	THTCLP-S-L1-7610-0.4-SC	L1	55.00	85.00	91.02	59.00	1	400	R7950
▲	THTCLP-S-L3A-7610-0.4-SC	L3A	55.00	85.00	91.02	59.00	1	400	R7950
▲	THTCLP-S-L4A-7610-0.4-SC	L4A	55.00	85.00	91.02	59.00	1	400	R7950
▲	THTCLP-S-L4B-7610-0.4-SC	L4B	55.00	85.00	91.02	59.00	1	400	R7950
▲	THTCLP-M-L4B-7610-0.3-SC	L4B	75.00	110.00	115.36	79.00	1	300	R7950
▲	THTCLP-L-L2-7610-0.2-SC	L2	105.00	155.00	160.12	109.00	1	200	R7950
▲	THTCLP-L-L3A-7610-0.2-SC	L3A	105.00	155.00	160.12	109.00	1	200	R7950
▲	THTCLP-L-L3B-7610-0.2-SC	L3B	105.00	155.00	160.12	109.00	1	200	R7950
<b>B-7594: Polypropylene</b>									
▲	THTCLP-S-L1-7594-0.4-SC	L1	55.00	85.00	91.02	59.00	1	400	R6000HF
▲	THTCLP-S-L2-7594-0.4-SC	L2	55.00	85.00	91.02	59.00	1	400	R6000HF
▲	THTCLP-S-L3A-7594-0.4-SC	L3A	55.00	85.00	91.02	59.00	1	400	R6000HF
▲	THTCLP-S-L4A-7594-0.4-SC	L4A	55.00	85.00	91.02	59.00	1	400	R6000HF
▲	THTCLP-S-L4B-7594-0.4-SC	L4B	55.00	85.00	91.02	59.00	1	400	R6000HF
▲	THTCLP-M-L1-7594-0.3-SC	L1	75.00	110.00	115.36	79.00	1	300	R6000HF
▲	THTCLP-M-L2-7594-0.3-SC	L2	75.00	110.00	115.36	79.00	1	300	R6000HF
▲	THTCLP-M-L3A-7594-0.3-SC	L3A	75.00	110.00	115.36	79.00	1	300	R6000HF
▲	THTCLP-M-L3B-7594-0.3-SC	L3B	75.00	110.00	115.36	79.00	1	300	R6000HF
▲	THTCLP-M-L4A-7594-0.3-SC	L4A	75.00	110.00	115.36	79.00	1	300	R6000HF
▲	THTCLP-M-L4B-7594-0.3-SC	L4B	75.00	110.00	115.36	79.00	1	300	R6000HF
▲	THTCLP-L-L1-7594-0.2-SC	L1	105.00	155.00	160.12	109.00	1	200	R6000HF
▲	THTCLP-L-L2-7594-0.2-SC	L2	105.00	155.00	160.12	109.00	1	200	R6000HF
▲	THTCLP-L-L3A-7594-0.2-SC	L3A	105.00	155.00	160.12	109.00	1	200	R6000HF
▲	THTCLP-L-L4B-7594-0.2-SC	L4B	105.00	155.00	160.12	109.00	1	200	R6000HF

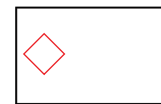
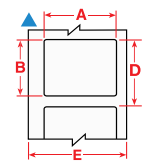

L1

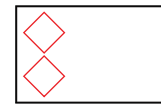

L2

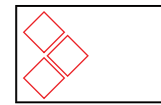

L3A

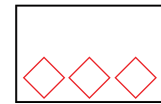

L3B

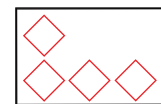

L4A

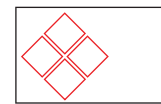

L4B

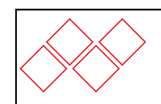

L4C

### Pre-printed GHS/CLP Labels for i3300 Label Printer

Diagram	Order Reference	Layout	Label Width A (mm)	Label Height B (mm)	Labels per Row	Labels per Package	Ribbon Series
<b>B-7569: Vinyl</b>							
▲	B30-18-7569-CLP4C	L4C	76.20	25.40	1	1000	B30-R10000
▲	B30-260-7569-CLP1	L1	84.99	55.00	1	340	B30-R10000
▲	B30-260-7569-CLP2	L2	84.99	55.00	1	340	B30-R10000
▲	B30-260-7569-CLP3A	L3A	84.99	55.00	1	340	B30-R10000
▲	B30-260-7569-CLP3B	L3B	84.99	55.00	1	340	B30-R10000
▲	B30-260-7569-CLP4A	L4A	84.99	55.00	1	340	B30-R10000
▲	B30-260-7569-CLP4B	L4B	84.99	55.00	1	340	B30-R10000
▲	B30-261-7569-CLP1	L1	110.00	75.00	1	270	B30-R10000
▲	B30-261-7569-CLP2	L2	110.00	75.00	1	270	B30-R10000
▲	B30-261-7569-CLP3A	L3A	110.00	75.00	1	270	B30-R10000
▲	B30-261-7569-CLP3B	L3B	110.00	75.00	1	270	B30-R10000
▲	B30-261-7569-CLP4A	L4A	110.00	75.00	1	270	B30-R10000
▲	B30-261-7569-CLP4B	L4B	110.00	75.00	1	270	B30-R10000
▲	B30-262-7569-CLP1	L1	154.99	104.98	1	200	B30-R10000
▲	B30-262-7569-CLP2	L2	154.99	104.98	1	200	B30-R10000
▲	B30-262-7569-CLP3A	L3A	154.99	104.98	1	200	B30-R10000
▲	B30-262-7569-CLP3B	L3B	154.99	104.98	1	200	B30-R10000
▲	B30-262-7569-CLP4A	L4A	154.99	104.98	1	200	B30-R10000
▲	B30-262-7569-CLP4B	L4B	154.99	104.98	1	200	B30-R10000

# Sorbent Products



## Lab Pack

- Ideal for medium sized spills.
- Water and chemical resistant drum protects sorbents.
- Easy access to products thanks to screw top lid.
- Drum can be used as shipping container for used sorbents.

**Kit contains:** 12 pads (40 cm x 50 cm), 3 socks (7.6 diam cm x 366 cm), 2 pillows (43 cm x 48 cm), 1 pair of gloves, 1 pair of goggles and 3 disposal bags

Order Reference	Article No.	Description	Quantity	Absorption Capacity (Ltrs)
SKO-20	813869	LAB PACK, Oil Only	1 Kit	57
SKA-20	813870	LAB PACK, Maintenance	1 Kit	56
SKH-20	813871	LAB PACK, Chemical	1 Kit	56



## SPC Spill Box

Pads in a convenient dispenser box allowing you to create multiple spill stations around your site!

- Reusable plastic box can be refilled once all the sorbents have been used.
- The Spill Box is light enough to be hung to laboratory and storage area walls or to be attached to a forklift.
- The bright yellow colour stands out for quick identification and use.
- Various application areas: in liquid storage areas, behind the seat of a truck, lab environments, in workstations that deal with liquids.

Order Reference	Article No.	Description	Total Qty/Pack
SA-SBA	813909	SPILL BOX, Maintenance, filled box with 15 pads	15 Pad(s) / Kit
SA-SBH	813910	SPILL BOX, Chemical, filled box with 10 pads	10 Pad(s) / Box



## Spill Response Plus

Spill Response Plus is a smaller size pad and roll designed to be highly absorbent, durable, low lint and to reduce waste.

- Dimpled design provides better looking, strong and durable product
- Roll is perforated so you only use what you need
- Includes universal (grey) and chemical (green) applications
- **Perfect to be used with Spill Safety Stations**

Order Reference	Article No.	Description	Colour	Total Qty/ Pack	Absorption Capacity (Ltrs)
MRO365-P	834176	ROLL, 19 cm x 15 m, Heavyweight, perforated & bonded, 60 pads per roll	Grey	1 Roll(s) / Bag	15
UN295-P	834177	ROLL, Medium weight, double perforated & bonded 19 cm x 15 m, 60 pads per roll	Green	1 Roll(s) / Bag	12.00

## SKH-Mini

A fully disposable spill kit to clean up small chemical spills easily and without risk of injuries.

- The autoclavable disposal bag is heat resistant up to 145°C to guarantee safe disposal of laboratory waste.
- Suited for spills of up to 1.7 litres, absorbing chemicals, water & oil based fluids.
- The specially designed disposable brush is intended to sweep up any broken glass or debris allowing a safe clean up without risk of injuries.
- Compact design: the SKH-MINI can easily be placed in any areas where it is most needed.
- Protective gloves are powder free, have roughened fingertips, increased tear resistance and a good chemical resistance for more safety.

**Contents:** 2 pads (40 cm x 50 cm), 1 pair of disposable chemical protective gloves, 1 autoclavable disposal bag, 1 disposable brush, and multilingual instruction guide



Order Reference	Article No.	Description	Quantity	Absorption Capacity (Ltrs)
SKH-MINI	813868	Disposable spill kit, chemical	4 Kits/Box	7.00

\*4 x 1.7 litres

## UN Pads & Rolls

For use when chemicals and hazardous liquids are involved!

- Chemically inert: product does not degrade or cause a dangerous chemical reaction with the adsorbed liquid.
- One-sided spunbond gives extra strength as well as lower lint.
- Perforated for flexibility – tear at the perforations for smaller sized pads to use only what you need.

### Pads

Order Reference	Article No.	Description	Total Qty/Pack	Absorption Capacity (Ltrs)
UN100-E	813842	PADS, 40 cm x 50 cm, Medium weight, perforated & bonded	100 Pad(s) / Box	89
UN1212-E	813843	PAD, Medium weight, bonded 30 cm x 30 cm, 50 pads/Bag, 4 Bags/disp.box	200 Pad(s) / Dispenser Box	77

### Rolls

Order Reference	Article No.	Description	Total Qty/Pack	Absorption Capacity (Ltrs)
UN15-2DP-E	813844	ROLL, Medium weight, double perforated & bonded 38 cm x 46 m	2 Roll(s) / Pack	155
UN15-DP-E	813845	ROLL, Medium weight, double perforated & bonded 38 cm x 46 m	1 Roll(s) / Box	78
UN15-DPS-E	813846	ROLL, Medium weight, double perforated & bonded 38 cm x 23 m	1 Roll(s) / Box	39
UN30-DP-E	813847	ROLL, Medium weight, double perforated & bonded 76 cm x 46 m	1 Roll(s) / Box	155
UN295-P	834177	ROLL, Medium weight, double perforated & bonded 19 cm x 15 m, 60 pads per roll	1 Roll(s) / Bag	12.00





**Belgium & Luxembourg**

+32 (0) 52 45 78 11  
benelux@bradycorp.com

**Czech Republic**

+420 776 302 229  
czechrepublic@bradycorp.com

**Denmark**

+45 66 14 44 00  
denmark@bradycorp.com

**France**

+33 (0) 3 20 76 94 48  
france@bradycorp.com

**Germany, Austria & Switzerland**

+49 (0) 6103 7598 660  
germany@bradycorp.com

**Hungary**

+36 23 500 275  
hungary@bradycorp.com

**Italy**

+39 02 26 00 00 22  
italy@bradycorp.com

**Netherlands**

+31 (0)70 323 62 98  
benelux@bradycorp.com

**Norway**

+47 70 13 40 00  
norway@bradycorp.com

**Poland**

+48 22 104 6262  
poland@bradycorp.com

**Qatar, Saudi Arabia & UAE**

+971 4881 2524  
me@bradycorp.com

**Slovakia**

+421 902 939 406  
slovakia@bradycorp.com

**South Africa**

+27 11 704 3295  
africa@bradycorp.com

**Spain & Portugal**

+34 900 902 993  
spain@bradycorp.com  
portugal@bradycorp.com

**Sweden, Finland, Estonia, Latvia,  
Lithuania**

+46 (0) 8 590 057 30  
sweden@bradycorp.com

**Turkey**

+90 212 264 02 20  
turkey@bradycorp.com

**UK & Ireland**

+44 (0) 1295 228 288  
uk@bradycorp.com

Our mission is to identify and protect people,  
products and premises



To help minimise our impact on the environment,  
Brady limits its number of reprints.

Updated versions are always available for  
download on [www.bradyeurope.com](http://www.bradyeurope.com).



Search for: EUR-M-513-EN



Y1455478

Your distributor



Omser (Scotland) Ltd  
incorporating Touch Print  
School Road, Gartocharn  
By Alexandria, G83 8RT  
T: 01389 830 408 F:01389 830 349  
sales@omser.co.uk www.omser.co.uk