



OMSER
(SCOTLAND) LTD.

incorporating

TOUCH PRINT

THE SIGN AND LABELLING SPECIALISTS



Print any label or sign with the versatile BradyPrinter i3300 Industrial Label Printer

BradyPrinter i3300 Industrial Label Printer

About BRADY



Once you have worked with BRADY, our name will stick with you, (just like our labels) because BRADY is one of the world's leading labelling and identification specialists.

Innovative

At BRADY we continue to improve. We have many customers from all industries, and we strive to be ahead of their needs by continuing to invest in research for even more performant solutions. By developing more user-friendly and efficient concepts, we give our thousands of customers the best in the market.

Strength

At BRADY, we believe our biggest strength is the wide range of identification and safety solutions we can offer our customers, whether it's labelling the smallest component or complete signage for an entire warehouse. We're also proud to offer many products and services - from printers, scanners and software to service contracts and on-site training - that compliment any identification job. And don't forget, our wide network of expert distributors can always offer you a tailor-made solution to meet your specific requirements.

Trust

For over a hundred years, BRADY has been connected with quality, trust and stability. We demand the best for your products and services, because we know, better than anyone, the importance of good and reliable identification. Identification looks like a small detail, but every professional knows that this kind of detail is crucial to any business.

Inform

We also have specialised dealers in your region, who can answer all your identification and labelling questions, specific to your activity. They will be happy to provide you with all kinds of options and solutions with no obligation.

Microsoft is a trademark of Microsoft Corporation, Bluetooth is a trademark of Bluetooth Sig, Inc., Android is a trademark of Google Inc.



Brady products are sold on the condition that the purchaser will test them in actual use and determine for himself/herself their suitability to his/her intended purpose. Brady warrants to the purchaser that Brady products are free from defects in material and workmanship but limits its obligation under this warranty to the replacement of the product which has been shown to Brady's satisfaction to have been defective at the time of its purchase.

The warranty does not extend to any persons who have acquired the product from the purchaser. It is in lieu of any other warranty, including every warranty of sale-ability, marketability or suitability for the intended purpose, and is also in lieu of any other obligation or liability on the part of Brady.

Under no circumstances will Brady be liable for losses, damage, costs or subsequent damage of whatever nature which may arise in connection with the use of, or inability to use, Brady's products.

Print any label or sign with the versatile BradyPrinter i3300 Industrial Label Printer

Table of contents

4	BradyPrinter i3300 introduction
5	BradyPrinter i3300 at a glance
6	Applications
8	Media offering
8	Ribbons
10	Facility & safety identification
19	Electrical / Automation identification
32	Product & general purpose identification
36	Electronics identification
38	Laboratory identification
44	Master material index
49	Software
50	BradyPrinter i3300 specifications
51	BradyPrinter i3300 kits and accessories

The Brady Advantage

When it comes to identification, safety and compliance, there's a clear advantage to working with Brady. We put our customers first in everything we do.

Our goal is to give you an unrivalled customer experience. We are relentlessly committed to performance and excellence - in our products, services and people.

Our products and solutions perform in ways that others simply can't match. Our people perform in ways that regularly exceed your expectations. And our focus and discipline work toward solid, long-term performance for our customers.

In short, Brady is the company you trust when performance matters most.

Learn more about the Brady Advantage at: www.bradyeurope.com



BradyPrinter i3300
Industrial Label Printer



Compatible labels & ribbons

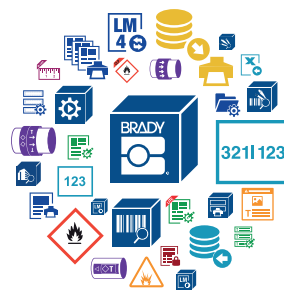

Software for label creation
and data integration



Printer technical specifications

Print any label or sign with the versatile BradyPrinter i3300 Industrial Label Printer

The BradyPrinter i3300 Industrial Label Printer is a completely hassle free, easy to use PC-based printer. It can print a full range of safety and facility labels and signs as well as die cut labels for wire identification, product identification and laboratory identification.



Print a huge range of labels & signs

With the BradyPrinter i3300, you can print a huge range of reliable labels and signs at your location in monocolour. More than 50 different Brady label materials are compatible with the BradyPrinter i3300. Labels & signs that can be printed with the BradyPrinter i3300 include:

- wire & cable identification labels
- product and laboratory identification labels
- safety and facility signs

These can be used both in- and outdoor, and include specialty solutions like ToughWash labels and ToughStripe floor marking.

Designed to last

The BradyPrinter i3300 prints on Brady's industrial grade labels that have been designed to last in challenging conditions. All Brady labels have been tested in line with international ASTM test methods and a technical data sheet is available for every material.

[Scan or click the QR code](#)



Extremely easy to use

The BradyPrinter i3300 is extremely easy to use and features auto-calibration and automatic label material setup. This will enable you to immediately start printing the signs and labels you need. Switching to another label material is easy and extremely fast thanks to the printer's 'drop-in' label materials and matching ink ribbons that can be switched out in less than 20 seconds. When used with Brady Workstation apps, a wide variety of sign & label design options becomes available.

BradyPrinter i3300 top features



No wasting labels with print smart technology

Print on every label or sleeve – no more blank first label. With print smart technology, the printer, labels, ribbons and software all work together for efficient label setup. It's all in the smart chip embedded in Brady materials – it stores the material size, type, colour, quantity and compatibility, and sets proper burn settings, sensor alignment and print speed. When installed, the chip sends that information to the printer and desktop software and auto calibrates without wasting any labels – and you get fast material setup and creation, without the waste.



Get no-hassle, 20-second material changeovers

Forget fumbling around with ribbon rolls that are great at rolling away or threading material around rollers or print heads. Switch to a new way of material changeovers with the BradyPrinter i3300 Industrial Label Printer. The easy-to-load label rolls and self-contained ribbons snap into place for easy 20-second material changeovers without cumbersome sensor adjustments. Switch materials frequently throughout the day? You'll save time to work on your more important tasks.

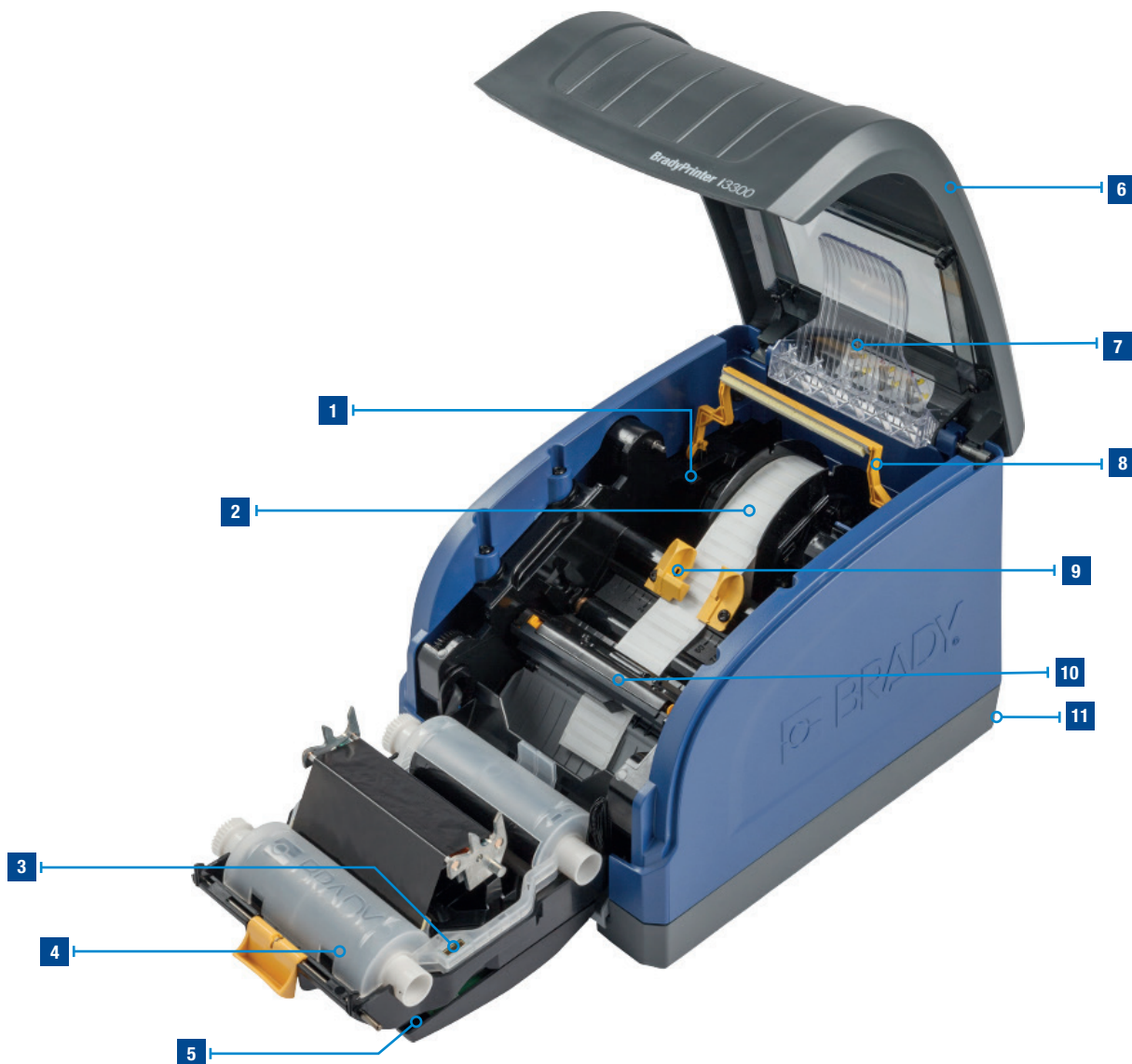

1 Media roll cartridge with auto part detection

Printer auto-detects installed label part, communicating printer setting and part setup information to both printer and Brady software

2 20-second media roll changeover

Media cartridge roll drops in and out of place quickly with minimal thread-through, no sensor adjustment, no calibration and no label waste

3 Ribbon cartridge with auto part detection

Printer auto-detects installed ribbon part, then sets correct print heat level and shows a warning if incorrect ribbon is used

4 5-second ribbon changeover

Ribbon cartridge snaps into place in one quick motion and guarantees the ink always faces the right direction to the print head

5 Color touchscreen control panel

Icons and sliders for easy printer setting adjustments and on-display part information and amount remaining

6 Top-loading design

Reduces footprint in your work area and simplifies media alignment and loading

7 Double-sided PermaSleeve bridge

Lowered into place to allow printing second side of double-sided PermaSleeve wire markers

8 Media wiper arm

Ensures dust-free surface and high print quality when printing large ink areas on continuous media. Felt pads are field-replaceable

9 Sensors located in guides

Label sensor is always correctly positioned as guides are closed, meaning no sensor location trial and error, no calibration required and no wasted labels

10 Integrated auto cutter

Built-in cutter for complete cut-through of media between labels, at end of job, or no cut at all

11 Interface options

2x USB, 1x USB 2.0, 1x Ethernet (back of printer)

Applications

Facility & Safety Identification



Safety signs



Pipe markers



Machine safety labels and tags



CLP/GHS Labels



Warehouse identification



Floormarking

Electrical, voice/datacom identification



Control panel labels



Self-laminating wire & cable markers



Inside panel component labels



Fibre optic cable markers



Cable tags



Wire marking sleeves

General & industrial identification



Rating plate labels



Name plates



Rough surface labels

Electronics identification



Electronic component labels



High resistant labels



Static dissipative labels



High-temperature identification labels

Laboratory identification & sample tracking



Centrifuge & PCR tube labels



Conical & large tube labels



Slide labels



Tissue cassette labels



Water dissolvable labels



Well plate labels

Media offering

We continuously try to improve & extend our label material offering, therefore make sure to check for firmware upgrades regularly, in order to make sure you always have access to the newest materials.

Material	
B-342	Heat-shrink Polyolefin Sleeve
B-345	High Temperature Heat-shrink Polyvinylidene Fluoride Sleeve
B-348	Polyolefin
B-422	Polyester
B-423	Polyester
B-424	Paper
B-425A	Polypropylene
B-427	Self-laminating Vinyl
B-428	Metallised Polyester
B-430	Polyester
B-432	Polyester
B-434	Metallised Polyester
B-435	Metallised Polyester
B-437	Polyvinylfluoride
B-438	Tamper-evident Metallised Polyester
B-461	Self-laminating Polyester
B-472	Polyimide
B-480A	Metallic, Non-metal Polyester
B-481	StainerBondz™ Polyester
B-482	Polyester
B-483	Polyester
B-483/B-634	Polyester with Polyester Overlamine
B-486B	Metallised Polyester
B-488	Polyester
B-489A	Polyester
B-490	Freezerbondz™ Polyester
B-492	Freezerbondz™ Polyester
B-498	Vinyl Cloth
B-499	Nylon Cloth

Material	
B-509	Magnetic Polyester
B-526	Phosphorescent Polyester
B-549	Polyester
B-551	Polyester Tag
B-565	Metallised Polyester
B-569	Polyester
B-581	Vinyl
B-584	Reflective Tape
B-593	Polyester
B-595	Vinyl
B-717	Polyimide
B-718	Polyimide
B-719	Polyimide
B-724	Polyimide
B-727	Polyimide
B-7425	Polypropylene
B-7563	Metallised Polyester
B-7569	Vinyl
B-7597	Polyethylene Tag
B-7598	Polyester Tag
B-7599	Polyethylene Tag
B-7641	Heat-shrink Polyolefin Sleeve
B-7642	Heat-shrink Polyolefin Sleeve
B-7643	Thermoplastic Polyether Polyurethane
B-7696	Vinyl Tag
B-787	Polyvinylfluoride
B-8423	Polyester
B-854	Metal Detectable Polyester
B-855	Polyester

Next to 800+ standard parts available including more than 51 label materials, customers can also offer their own label specification for custom materials, shapes, sizes, colours and layouts that can be printed on the BradyPrinter i3300.

Ribbons

Print ribbons

“Drop & Click” Print ribbons for quick and easy supply changes

Order Reference	Colour	Width A (mm) x Length B (m)
B30-R10000	Black	110.00 x 60.90
B30-R10000-BL	Blue	110.00 x 60.90
B30-R10000-GN	Green	110.00 x 60.90
B30-R10000-MA	Magenta	110.00 x 60.90
B30-R10000-OR	Orange	110.00 x 60.90
B30-R10000-RD	Red	110.00 x 60.90
B30-R10000-WT	White	110.00 x 60.90
B30-R10000-YL	Yellow	110.00 x 60.90
B30-R6000HF	Black	110.00 x 60.90
B30-R4300	Black	110.00 x 60.90
B30-R6600	Black	110.00 x 60.90
B30-R4400-WT	White	110.00 x 60.90
B30-R4500*	Silver	110.00 x 60.90
B30-R6700-WT	White	110.00 x 60.90
B30-R6400	Black	110.00 x 60.90
B30-R6200	Black	110.00 x 60.90
B30-R10000-YL2**	Yellow	110.00 x 60.90
B30-R6000C***	Black	110.00 x 60.90

- Tough, smear-proof ribbons that produce
- long-lasting printed text
- Print can withstand years in industrial areas and outdoor conditions
- Ribbons supplied in self-contained cartridges that drop straight into the printer with a “click”
- No calibrating, no threading, no waste, no hassle and the ink will always be facing the right direction
- Printer notifies user if installed ribbon is not recommended for the installed labels



*This ribbon is for use with B-342 and B-345 black PermaSleeves only

**For printing yellow onto white B-595 use B30-R10000-YL. For printing yellow onto other colours of B-595 use B30-R10000-YL2

***Black Heavy-Duty print ribbon to print Ochre B-595

i3300 Print ribbon/material compatibility

B Number	Material		B30-R4300	B30-R4400-WT	B30-R4500*	B30-R6000HF	B30-R6200	B30-R6400	B30-R6600	B30-R6700-WT	B30-R10000	B30-R10000-WT	B30-R10000	B30-R10000-YL2**
			Black	White	Silver	Black	Black	Black	Black	White	Black	White	Colours	Yellow
B-342	Heat-shrink Polyolefin Sleeve	Matt												
B-345	High Temperature Heat-shrink Polyvinylidene Fluoride Sleeve	Matt		✓		✓			✓					
B-422	Polyester	Gloss				✓	✓							
B-423	Polyester	Gloss				✓	✓							
B-424	Paper	Matt	✓											
B-425A	Polypropylene	Matt	✓					✓						
B-427	Self-laminating Vinyl	Matt												
B-428	Metallised Polyester	Matt	✓											
B-430	Polyester	Gloss		✓		✓	✓							
B-432	Polyester	Gloss		✓		✓								
B-434	Metallised Polyester	Gloss				✓								
B-435	Metallised Polyester	Gloss				✓								
B-437	Polyvinylfluoride	Matt	✓											
B-438	Tamper-evident Metallised Polyester	Matt	✓								✓			
B-461	Self-laminating Polyester	Matt	✓				✓							
B-472	Polyimide	Matt	✓				✓							
B-481	StainerBondz™ Polyester	Matt						✓						
B-482	Polyester	Matt						✓						
B-483	Polyester	Gloss				✓								
B-484A	Polyester	Gloss				✓								
B-486B	Metallised Polyester	Matt	✓											
B-488	Polyester	Matt	✓											
B-489A	Polyester	Matt	✓											
B-490	Freezerbondz™ Polyester	Matt	✓											
B-492	Freezerbondz™ Polyester	Matt						✓						
B-498	Vinyl Cloth	Semi-gloss	✓				✓							
B-499	Nylon Cloth	Matt												
B-509	Magnetic Polyester					✓					✓		✓	
B-526	Phosphorescent Polyester	Gloss				✓					✓		✓	
B-549	Polyester	Gloss						✓			✓	✓	✓	
B-551	Polyester Tag					✓					✓	✓	✓	
B-565	Metallised Polyester	Matt				✓					✓			
B-569	Polyester					✓					✓	✓	✓	
B-581	Vinyl	Gloss				✓					✓	✓	✓	
B-584	Reflective Tape	Gloss				✓					✓		✓	
B-593	Polyester	Gloss		✓		✓								
B-595	Vinyl	Gloss				✓				✓	✓	✓	✓	✓
B-717	Polyimide	Gloss				✓								
B-718	Polyimide	Gloss				✓								
B-719	Polyimide	Matt				✓								
B-724	Polyimide	Matt	✓											
B-727	Polyimide	Gloss				✓								
B-854	Metal Detectable Polyester	Matt				✓								
B-855	Polyester	Matt				✓								
B-7563	Metallised Polyester	Satin				✓	✓							
B-7569	Vinyl	Gloss				✓					✓	✓	✓	
B-7597	Polyethylene Tag	Matt	✓											
B-7641	Heat-shrink Polyolefin Sleeve	Matt				✓								
B-7642	Heat-shrink Polyolefin Sleeve	Matt	✓					✓						
B-8423	Polyester	Satin				✓	✓							

*This ribbon is for use with B-342 and B-345 Black PermaSleeves only **For printing yellow onto white B-595 use B30-R10000-YL. For printing yellow onto other colours of B-595 use B30-R10000-YL2



B-595 Pre-printed Pre-cut blank sign headers

For creating Arc Flash and safety warning labels in seconds

- Allows the printer to create multi-colour signs fast - in a single print pass
- Indoor/Outdoor grade material conforms to rough, irregular and “difficult to adhere to” surfaces

Diagram	Order Reference		Width A (mm)	Height B (mm)	Labels per Row	Labels per Roll	Recommended Ribbon	Printer Compatibility
⊗	B30-25-595-ANSIDA	DANGER	101.00	152.00	1	175	B30-R10000	BBP35, BBP37, i3300, S3000, S3100
⊗	B30-241-595-ANSIDA	DANGER	57.00	75.00	1	300	B30-R10000	BBP35, BBP37, i3300, S3000, S3100
⊗	B30-25-595-ANSICA	CAUTION	101.00	152.00	1	175	B30-R10000	BBP35, BBP37, i3300, S3000, S3100
⊗	B30-241-595-ANSICA	CAUTION	57.00	75.00	1	300	B30-R10000	BBP35, BBP37, i3300, S3000, S3100
⊗	B30-25-595-ANSIWA	WARNING	101.00	152.00	1	175	B30-R10000	BBP35, BBP37, i3300, S3000, S3100
⊗	B30-241-595-ANSIWA	WARNING	57.00	75.00	1	300	B30-R10000	BBP35, BBP37, i3300, S3000, S3100
⊗	B30-25-595-ANSINO	NOTICE	101.00	152.00	1	175	B30-R10000	BBP35, BBP37, i3300, S3000, S3100
⊗	B30-241-595-ANSINO	NOTICE	57.00	75.00	1	300	B30-R10000	BBP35, BBP37, i3300, S3000, S3100
⊗	B30-25-595-OSHADA	DANGER	101.00	152.00	1	175	B30-R10000	BBP35, BBP37, i3300, S3000, S3100
⊗	B30-241-595-OSHADA	DANGER	57.00	75.00	1	300	B30-R10000	BBP35, BBP37, i3300, S3000, S3100
⊗	B30-25-595-OSHACA*	CAUTION	101.00	152.00	1	175	B30-R10000	BBP35, BBP37, i3300, S3000, S3100
⊗	B30-241-595-OSHACA*	CAUTION	57.00	75.00	1	300	B30-R10000	BBP35, BBP37, i3300, S3000, S3100
▲	B30-25-595-BLNKWT		101.00	152.00	1	175	B30-R10000	BBP35, BBP37, i3300, S3000, S3100
▲	B30-241-595-BLNKWT		57.00	75.00	1	300	B30-R10000	BBP35, BBP37, i3300, S3000, S3100
▲	B30-242-595-BLNKWT		29.00	72.00	1	300	B30-R10000	BBP35, BBP37, i3300, S3000, S3100
▲	B30-219-595-BLNKWT		57.00	98.00	1	250	B30-R10000	BBP35, BBP37, i3300, S3000, S3100
▲	B30-25-595-BLNKYL		101.00	152.00	1	175	B30-R10000	BBP35, BBP37, i3300, S3000, S3100
▲	B30-241-595-BLNKYL		57.00	75.00	1	300	B30-R10000	BBP35, BBP37, i3300, S3000, S3100

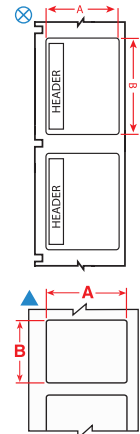

*The text area below the header is yellow. Text area below other signs are white B30-R10000 coloured ribbons can also be used on these parts



B-551 Non-adhesive pre-printed & pre-cut safety tags

Pre-printed and pre-cut to save you time

- Non-adhesive semi-rigid polyester card stock
 - Tags are pre-cut with hole and chamfered corners
 - Perforated between tags
 - Snap-in plastic grommets available for extra strength around mounting hole.
- Order reference: 020596

Diagram	Order Reference	Colour	Label Width A (mm)	Label Height B (mm)	Label Length B (m)	Vertical Repeat D (mm)	Labels per Roll	Printer Ribbon Series	Printer Compatibility
B-551: Polyester Tag									
⊗	B30-255-551-OSHADA	Black & Red on White	82.55	146.05	-	-	100	B30-R10000	BBP35, BBP37, i3300, S3000, S3100
⊗	B30-255-551-ANSICA	Black on Yellow	82.55	146.05	-	-	100	B30-R10000	BBP35, BBP37, i3300, S3000, S3100
⊗	B30-255-551-ANSIDA	White on Red	82.55	146.05	-	-	100	B30-R10000	BBP35, BBP37, i3300, S3000, S3100

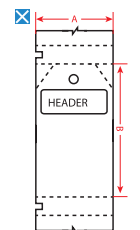

B-595 High performance indoor/outdoor vinyl

For general facility and safety identification: our best industrial vinyl yet

- Durable, low-shrink vinyl with our most aggressive adhesive
- Conforms to irregular, curved, rough and highly textured surfaces (painted cinder blocks, uneven wood, textured plastics, paper-jacketed pipes, powder-coated surfaces)
- Adheres to “difficult low-surface energy items (PVC piping, blow-moulded equipment cases, ABS plastics, recycled plastics)



Diagram	Order Reference	Colour	Label Width A (mm)	Label Height B (mm)	Label Length B (m)	Vertical Repeat D (mm)	Labels per Roll	Printer Ribbon Series	Printer Compatibility
B-595: Vinyl									
∞	B30C-500-595-BK	Black	12.70	-	30.40	-	1	B30-R10000-WT	BBP35, BBP37, i3300, S3000, S3100
∞	B30C-500-595-BL	Blue	12.70	-	30.40	-	1	B30-R10000-WT	BBP35, BBP37, i3300, S3000, S3100
∞	B30C-500-595-BR	Brown	12.70	-	30.40	-	1	B30-R10000-WT	BBP35, BBP37, i3300, S3000, S3100
∞	B30C-500-595-CL	Clear	12.70	-	30.40	-	1	B30-R10000	BBP35, BBP37, i3300, S3000, S3100
∞	B30C-500-595-GD	Gold	12.70	-	30.40	-	1	B30-R10000	BBP35, BBP37, i3300, S3000, S3100
∞	B30C-500-595-GN	Green	12.70	-	30.40	-	1	B30-R10000-WT	BBP35, BBP37, i3300, S3000, S3100
∞	B30C-500-595-GY	Grey	12.70	-	30.40	-	1	B30-R10000	BBP35, BBP37, i3300, S3000, S3100
∞	B30C-500-595-OR	Orange	12.70	-	30.40	-	1	B30-R10000	BBP35, BBP37, i3300, S3000, S3100
∞	B30C-500-595-PL	Purple	12.70	-	30.40	-	1	B30-R10000-WT	BBP35, BBP37, i3300, S3000, S3100
∞	B30C-500-595-RD	Red	12.70	-	30.40	-	1	B30-R10000-WT	BBP35, BBP37, i3300, S3000, S3100
∞	B30C-500-595-WT	White	12.70	-	30.40	-	1	B30-R10000	BBP35, BBP37, i3300, S3000, S3100
∞	B30C-500-595-YL	Yellow	12.70	-	30.40	-	1	B30-R10000	BBP35, BBP37, i3300, S3000, S3100
∞	B30C-1125-595-BK	Black	29.00	-	30.40	-	1	B30-R10000-WT	BBP35, BBP37, i3300, S3000, S3100
∞	B30C-1125-595-BL	Blue	29.00	-	30.40	-	1	B30-R10000-WT	BBP35, BBP37, i3300, S3000, S3100
∞	B30C-1125-595-BR	Brown	29.00	-	30.40	-	1	B30-R10000-WT	BBP35, BBP37, i3300, S3000, S3100
∞	B30C-1125-595-CL	Clear	29.00	-	30.40	-	1	B30-R10000	BBP35, BBP37, i3300, S3000, S3100
∞	B30C-1125-595-GD	Gold	29.00	-	30.40	-	1	B30-R10000	BBP35, BBP37, i3300, S3000, S3100
∞	B30C-1125-595-GN	Green	29.00	-	30.40	-	1	B30-R10000-WT	BBP35, BBP37, i3300, S3000, S3100
∞	B30C-1125-595-GY	Grey	29.00	-	30.40	-	1	B30-R10000	BBP35, BBP37, i3300, S3000, S3100
∞	B30C-1125-595-OC	Ochre	29.00	-	30.40	-	1	B30-R60000C	BBP35, BBP37, i3300, S3000, S3100
∞	B30C-1125-595-OR	Orange	29.00	-	30.40	-	1	B30-R10000	BBP35, BBP37, i3300, S3000, S3100
∞	B30C-1125-595-PL	Purple	29.00	-	30.40	-	1	B30-R10000-WT	BBP35, BBP37, i3300, S3000, S3100
∞	B30C-1125-595-RD	Red	29.00	-	30.40	-	1	B30-R10000-WT	BBP35, BBP37, i3300, S3000, S3100
∞	B30C-1125-595-WT	White	29.00	-	30.40	-	1	B30-R10000	BBP35, BBP37, i3300, S3000, S3100
∞	B30C-1125-595-YL	Yellow	29.00	-	30.40	-	1	B30-R10000	BBP35, BBP37, i3300, S3000, S3100
∞	B30C-2250-595-BK	Black	57.00	-	30.40	-	1	B30-R10000-WT	BBP35, BBP37, i3300, S3000, S3100
∞	B30C-2250-595-BL	Blue	57.00	-	30.40	-	1	B30-R10000-WT	BBP35, BBP37, i3300, S3000, S3100
∞	B30C-2250-595-BR	Brown	57.00	-	30.40	-	1	B30-R10000-WT	BBP35, BBP37, i3300, S3000, S3100
∞	B30C-2250-595-CL	Clear	57.00	-	30.40	-	1	B30-R10000	BBP35, BBP37, i3300, S3000, S3100
∞	B30C-2250-595-GD	Gold	57.00	-	30.40	-	1	B30-R10000	BBP35, BBP37, i3300, S3000, S3100
∞	B30C-2250-595-GN	Green	57.00	-	30.40	-	1	B30-R10000-WT	BBP35, BBP37, i3300, S3000, S3100
∞	B30C-2250-595-GY	Grey	57.00	-	30.40	-	1	B30-R10000	BBP35, BBP37, i3300, S3000, S3100
∞	B30C-2250-595-OC	Ochre	57.00	-	30.40	-	1	B30-R60000C	BBP35, BBP37, i3300, S3000, S3100
∞	B30C-2250-595-OR	Orange	57.00	-	30.40	-	1	B30-R10000	BBP35, BBP37, i3300, S3000, S3100
∞	B30C-2250-595-PL	Purple	57.00	-	30.40	-	1	B30-R10000-WT	BBP35, BBP37, i3300, S3000, S3100
∞	B30C-2250-595-RD	Red	57.00	-	30.40	-	1	B30-R10000-WT	BBP35, BBP37, i3300, S3000, S3100
∞	B30C-2250-595-WT	White	57.00	-	30.40	-	1	B30-R10000	BBP35, BBP37, i3300, S3000, S3100
∞	B30C-2250-595-YL	Yellow	57.00	-	30.40	-	1	B30-R10000	BBP35, BBP37, i3300, S3000, S3100
∞	B30C-3000-595-WT	White	75.00	-	30.40	-	1	B30-R10000	BBP35, BBP37, i3300, S3000, S3100
∞	B30C-3000-595-YL	Yellow	75.00	-	30.40	-	1	B30-R10000	BBP35, BBP37, i3300, S3000, S3100
∞	B30C-4000-595-BK	Black	101.00	-	30.40	-	1	B30-R10000-WT	BBP35, BBP37, i3300, S3000, S3100
∞	B30C-4000-595-BL	Blue	101.00	-	30.40	-	1	B30-R10000-WT	BBP35, BBP37, i3300, S3000, S3100
∞	B30C-4000-595-BR	Brown	101.00	-	30.40	-	1	B30-R10000-WT	BBP35, BBP37, i3300, S3000, S3100
∞	B30C-4000-595-CL	Clear	101.00	-	30.40	-	1	B30-R10000	BBP35, BBP37, i3300, S3000, S3100
∞	B30C-4000-595-GD	Gold	101.00	-	30.40	-	1	B30-R10000	BBP35, BBP37, i3300, S3000, S3100
∞	B30C-4000-595-GN	Green	101.00	-	30.40	-	1	B30-R10000-WT	BBP35, BBP37, i3300, S3000, S3100
∞	B30C-4000-595-GY	Grey	101.00	-	30.40	-	1	B30-R10000	BBP35, BBP37, i3300, S3000, S3100
∞	B30C-4000-595-OC	Ochre	101.00	-	30.40	-	1	B30-R60000C	BBP35, BBP37, i3300, S3000, S3100
∞	B30C-4000-595-OR	Orange	101.00	-	30.40	-	1	B30-R10000	BBP35, BBP37, i3300, S3000, S3100
∞	B30C-4000-595-PL	Purple	101.00	-	30.40	-	1	B30-R10000-WT	BBP35, BBP37, i3300, S3000, S3100
∞	B30C-4000-595-RD	Red	101.00	-	30.40	-	1	B30-R10000-WT	BBP35, BBP37, i3300, S3000, S3100
∞	B30C-4000-595-WT	White	101.00	-	30.40	-	1	B30-R10000	BBP35, BBP37, i3300, S3000, S3100
∞	B30C-4000-595-YL	Yellow	101.00	-	30.40	-	1	B30-R10000	BBP35, BBP37, i3300, S3000, S3100

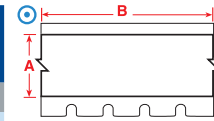

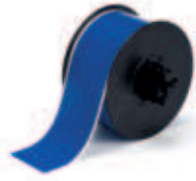

B-569 High performance polyester

For labelling stainless steel and smooth surfaces

- Low-halide content for labelling stainless steel pipes and surfaces
- Applies best to very smooth surfaces and ideal for mounting to rigid panels

Diagram	Order Reference	Colour	Label Width A (mm)	Label Height B (mm)	Label Length B (m)	Vertical Repeat D (mm)	Labels per Roll	Printer Ribbon Series	Printer Compatibility
B-569: Polyester									
∞	B30C-500-569-BK	Black	12.70	-	30.40	-	1	B30-R10000-WT	BBP35, BBP37, i3300, S3000, S3100
∞	B30C-500-569-BL	Blue	12.70	-	30.40	-	1	B30-R10000-WT	BBP35, BBP37, i3300, S3000, S3100
∞	B30C-500-569-BR	Brown	12.70	-	30.40	-	1	B30-R10000-WT	BBP35, BBP37, i3300, S3000, S3100
∞	B30C-500-569-CL	Clear	12.70	-	30.40	-	1	B30-R10000	BBP35, BBP37, i3300, S3000, S3100
∞	B30C-500-569-GN	Green	12.70	-	30.40	-	1	B30-R10000-WT	BBP35, BBP37, i3300, S3000, S3100
∞	B30C-500-569-GY	Grey	12.70	-	30.40	-	1	B30-R10000	BBP35, BBP37, i3300, S3000, S3100
∞	B30C-500-569-LB	Light Blue	12.70	-	30.40	-	1	B30-R10000	BBP35, BBP37, i3300, S3000, S3100
∞	B30C-500-569-OC	Ochre	12.70	-	30.40	-	1	B30-R10000	BBP35, BBP37, i3300, S3000, S3100
∞	B30C-500-569-OR	Orange	12.70	-	30.40	-	1	B30-R10000	BBP35, BBP37, i3300, S3000, S3100
∞	B30C-500-569-PK	Pink	12.70	-	30.40	-	1	B30-R10000	BBP35, BBP37, i3300, S3000, S3100
∞	B30C-500-569-PL	Purple	12.70	-	30.40	-	1	B30-R10000-WT	BBP35, BBP37, i3300, S3000, S3100
∞	B30C-500-569-RD	Red	12.70	-	30.40	-	1	B30-R10000-WT	BBP35, BBP37, i3300, S3000, S3100
∞	B30C-500-569-SB	Sky Blue	12.70	-	30.40	-	1	B30-R10000	BBP35, BBP37, i3300, S3000, S3100
∞	B30C-500-569-TN	Tan	12.70	-	30.40	-	1	B30-R10000	BBP35, BBP37, i3300, S3000, S3100
∞	B30C-500-569-WT	White	12.70	-	30.40	-	1	B30-R10000	BBP35, BBP37, i3300, S3000, S3100
∞	B30C-500-569-YL	Yellow	12.70	-	30.40	-	1	B30-R10000	BBP35, BBP37, i3300, S3000, S3100
∞	B30C-1125-569-BK	Black	29.00	-	30.40	-	1	B30-R10000-WT	BBP35, BBP37, i3300, S3000, S3100
∞	B30C-1125-569-BL	Blue	29.00	-	30.40	-	1	B30-R10000-WT	BBP35, BBP37, i3300, S3000, S3100
∞	B30C-1125-569-BR	Brown	29.00	-	30.40	-	1	B30-R10000-WT	BBP35, BBP37, i3300, S3000, S3100
∞	B30C-1125-569-CL	Clear	29.00	-	30.40	-	1	B30-R10000	BBP35, BBP37, i3300, S3000, S3100
∞	B30C-1125-569-GN	Green	29.00	-	30.40	-	1	B30-R10000-WT	BBP35, BBP37, i3300, S3000, S3100
∞	B30C-1125-569-GY	Grey	29.00	-	30.40	-	1	B30-R10000	BBP35, BBP37, i3300, S3000, S3100
∞	B30C-1125-569-LB	Light Blue	29.00	-	30.40	-	1	B30-R10000	BBP35, BBP37, i3300, S3000, S3100
∞	B30C-1125-569-OC	Ochre	29.00	-	30.40	-	1	B30-R10000	BBP35, BBP37, i3300, S3000, S3100
∞	B30C-1125-569-OR	Orange	29.00	-	30.40	-	1	B30-R10000	BBP35, BBP37, i3300, S3000, S3100
∞	B30C-1125-569-PK	Pink	29.00	-	30.40	-	1	B30-R10000	BBP35, BBP37, i3300, S3000, S3100
∞	B30C-1125-569-PL	Purple	29.00	-	30.40	-	1	B30-R10000-WT	BBP35, BBP37, i3300, S3000, S3100
∞	B30C-1125-569-RD	Red	29.00	-	30.40	-	1	B30-R10000-WT	BBP35, BBP37, i3300, S3000, S3100
∞	B30C-1125-569-SB	Sky Blue	29.00	-	30.40	-	1	B30-R10000	BBP35, BBP37, i3300, S3000, S3100
∞	B30C-1125-569-TN	Tan	29.00	-	30.40	-	1	B30-R10000	BBP35, BBP37, i3300, S3000, S3100
∞	B30C-1125-569-WT	White	29.00	-	30.40	-	1	B30-R10000	BBP35, BBP37, i3300, S3000, S3100
∞	B30C-1125-569-YL	Yellow	29.00	-	30.40	-	1	B30-R10000	BBP35, BBP37, i3300, S3000, S3100
∞	B30C-2250-569-BK	Black	57.00	-	30.40	-	1	B30-R10000-WT	BBP35, BBP37, i3300, S3000, S3100
∞	B30C-2250-569-BL	Blue	57.00	-	30.40	-	1	B30-R10000-WT	BBP35, BBP37, i3300, S3000, S3100
∞	B30C-2250-569-BR	Brown	57.00	-	30.40	-	1	B30-R10000-WT	BBP35, BBP37, i3300, S3000, S3100
∞	B30C-2250-569-CL	Clear	57.00	-	30.40	-	1	B30-R10000	BBP35, BBP37, i3300, S3000, S3100
∞	B30C-2250-569-GN	Green	57.00	-	30.40	-	1	B30-R10000-WT	BBP35, BBP37, i3300, S3000, S3100
∞	B30C-2250-569-GY	Grey	57.00	-	30.40	-	1	B30-R10000	BBP35, BBP37, i3300, S3000, S3100
∞	B30C-2250-569-LB	Light Blue	57.00	-	30.40	-	1	B30-R10000	BBP35, BBP37, i3300, S3000, S3100
∞	B30C-2250-569-OC	Ochre	57.00	-	30.40	-	1	B30-R10000	BBP35, BBP37, i3300, S3000, S3100
∞	B30C-2250-569-OR	Orange	57.00	-	30.40	-	1	B30-R10000	BBP35, BBP37, i3300, S3000, S3100
∞	B30C-2250-569-PK	Pink	57.00	-	30.40	-	1	B30-R10000	BBP35, BBP37, i3300, S3000, S3100
∞	B30C-2250-569-PL	Purple	57.00	-	30.40	-	1	B30-R10000-WT	BBP35, BBP37, i3300, S3000, S3100
∞	B30C-2250-569-RD	Red	57.00	-	30.40	-	1	B30-R10000-WT	BBP35, BBP37, i3300, S3000, S3100
∞	B30C-2250-569-SB	Sky Blue	57.00	-	30.40	-	1	B30-R10000	BBP35, BBP37, i3300, S3000, S3100
∞	B30C-2250-569-TN	Tan	57.00	-	30.40	-	1	B30-R10000	BBP35, BBP37, i3300, S3000, S3100
∞	B30C-2250-569-WT	White	57.00	-	30.40	-	1	B30-R10000	BBP35, BBP37, i3300, S3000, S3100
∞	B30C-2250-569-YL	Yellow	57.00	-	30.40	-	1	B30-R10000	BBP35, BBP37, i3300, S3000, S3100
∞	B30C-3000-569-WT	White	75.00	-	30.40	-	1	B30-R10000	BBP35, BBP37, i3300, S3000, S3100
∞	B30C-4000-569-BK	Black	101.00	-	30.40	-	1	B30-R10000-WT	BBP35, BBP37, i3300, S3000, S3100
∞	B30C-4000-569-BL	Blue	101.00	-	30.40	-	1	B30-R10000-WT	BBP35, BBP37, i3300, S3000, S3100
∞	B30C-4000-569-BR	Brown	101.00	-	30.40	-	1	B30-R10000-WT	BBP35, BBP37, i3300, S3000, S3100
∞	B30C-4000-569-CL	Clear	101.00	-	30.40	-	1	B30-R10000	BBP35, BBP37, i3300, S3000, S3100
∞	B30C-4000-569-GN	Green	101.00	-	30.40	-	1	B30-R10000-WT	BBP35, BBP37, i3300, S3000, S3100
∞	B30C-4000-569-GY	Grey	101.00	-	30.40	-	1	B30-R10000	BBP35, BBP37, i3300, S3000, S3100
∞	B30C-4000-569-LB	Light Blue	101.00	-	30.40	-	1	B30-R10000	BBP35, BBP37, i3300, S3000, S3100

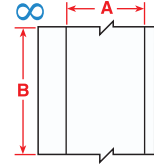

B-569 High performance polyester (continued)



Diagram	Order Reference	Colour	Label Width A (mm)	Label Height B (mm)	Label Length B (m)	Vertical Repeat D (mm)	Labels per Roll	Printer Ribbon Series	Printer Compatibility
∞	B30C-4000-569-OC	Ochre	101.00	-	30.40	-	1	B30-R10000	BBP35, BBP37, i3300, S3000, S3100
∞	B30C-4000-569-OR	Orange	101.00	-	30.40	-	1	B30-R10000	BBP35, BBP37, i3300, S3000, S3100
∞	B30C-4000-569-PK	Pink	101.00	-	30.40	-	1	B30-R10000	BBP35, BBP37, i3300, S3000, S3100
∞	B30C-4000-569-PL	Purple	101.00	-	30.40	-	1	B30-R10000-WT	BBP35, BBP37, i3300, S3000, S3100
∞	B30C-4000-569-RD	Red	101.00	-	30.40	-	1	B30-R10000-WT	BBP35, BBP37, i3300, S3000, S3100
∞	B30C-4000-569-SB	Sky Blue	101.00	-	30.40	-	1	B30-R10000	BBP35, BBP37, i3300, S3000, S3100
∞	B30C-4000-569-TN	Tan	101.00	-	30.40	-	1	B30-R10000	BBP35, BBP37, i3300, S3000, S3100
∞	B30C-4000-569-WT	White	101.00	-	30.40	-	1	B30-R10000	BBP35, BBP37, i3300, S3000, S3100
∞	B30C-4000-569-YL	Yellow	101.00	-	30.40	-	1	B30-R10000	BBP35, BBP37, i3300, S3000, S3100

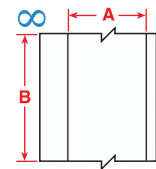











B-595 Pre-printed right-to-know chemical labels

For quickly creating NFPA and colour bar labels

- Allows the printer to produce 5 colour chemical labels in a single print pass
- Indoor/Outdoor grade material withstands exposure to moisture, chemicals and handling



Diagram	Order Reference		Width A (mm)	Height B (mm)	Labels per Row	Labels per Roll	Recommended Ribbon	Printer Compatibility
▲	B30-246-595-HMIG		29.00	82.50	1	300	B30-R10000	BBP35, BBP37, i3300, S3000, S3100
▲	B30-246-595-NFR		29.00	82.50	1	300	B30-R10000	BBP35, BBP37, i3300, S3000, S3100
▲	B30-244-595-CB		57.00	57.00	1	365	B30-R10000	BBP35, BBP37, i3300, S3000, S3100
▲	B30-244-595-NFPA		57.00	57.00	1	365	B30-R10000	BBP35, BBP37, i3300, S3000, S3100
▲	B30-244-595-DIAM		57.00	57.00	1	365	B30-R10000	BBP35, BBP37, i3300, S3000, S3100
▲	B30-244-595-HMIG		57.00	57.00	1	365	B30-R10000	BBP35, BBP37, i3300, S3000, S3100
▲	B30-245-595-CB		57.00	101.60	1	240	B30-R10000	BBP35, BBP37, i3300, S3000, S3100
▲	B30-245-595-NFPA		57.00	101.60	1	240	B30-R10000	BBP35, BBP37, i3300, S3000, S3100
▲	B30-161-595-NFPA		101.00	101.00	1	240	B30-R10000	BBP35, BBP37, i3300, S3000, S3100
▲	B30-263-595-NFPA		101.00	159.00	1	170	B30-R10000	BBP35, BBP37, i3300, S3000, S3100
▲	B30-263-595-CB		101.00	159.00	1	170	B30-R10000	BBP35, BBP37, i3300, S3000, S3100

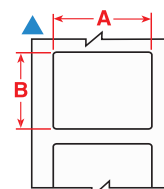

B-7569 Pre-printed CLP/GHS chemical labels

Print 2 colour CLP/GHS labels in one fast print pass

- Blank labels with pre-printed red diamonds allow printer to produce 2 colour CLP/GHS labels in one print pass
- 3 sizes of labels, each with 6 diamond layouts that match templates in MarkWare Software
- Indoor/outdoor vinyl material withstands exposure to moisture, chemicals and handling
- MarkWare Software 3.9.1 or higher required (upgrades available for current MarkWare owners)



Diagram	Order Reference		Width A (mm)	Height B (mm)	Labels per Row	Labels per Roll	Recommended Ribbon	Printer Compatibility
	B30-260-7569-CLP1		55.00	85.00	1	340	B30-R10000	BBP35, BBP37, i3300, S3000, S3100
	B30-260-7569-CLP2		55.00	85.00	1	340	B30-R10000	BBP35, BBP37, i3300, S3000, S3100
	B30-260-7569-CLP3A		55.00	85.00	1	340	B30-R10000	BBP35, BBP37, i3300, S3000, S3100
	B30-260-7569-CLP3B		55.00	85.00	1	340	B30-R10000	BBP35, BBP37, i3300, S3000, S3100
	B30-260-7569-CLP4A		55.00	85.00	1	340	B30-R10000	BBP35, BBP37, i3300, S3000, S3100
	B30-260-7569-CLP4B		55.00	85.00	1	340	B30-R10000	BBP35, BBP37, i3300, S3000, S3100
	B30-261-7569-CLP1		75.00	110.00	1	270	B30-R10000	BBP35, BBP37, i3300, S3000, S3100
	B30-261-7569-CLP2		75.00	110.00	1	270	B30-R10000	BBP35, BBP37, i3300, S3000, S3100
	B30-261-7569-CLP3A		75.00	110.00	1	270	B30-R10000	BBP35, BBP37, i3300, S3000, S3100
	B30-261-7569-CLP3B		75.00	110.00	1	270	B30-R10000	BBP35, BBP37, i3300, S3000, S3100
	B30-261-7569-CLP4A		75.00	110.00	1	270	B30-R10000	BBP35, BBP37, i3300, S3000, S3100
	B30-261-7569-CLP4B		75.00	110.00	1	270	B30-R10000	BBP35, BBP37, i3300, S3000, S3100
	B30-262-7569-CLP1		105.00	155.00	1	200	B30-R10000	BBP35, BBP37, i3300, S3000, S3100
	B30-262-7569-CLP2		105.00	155.00	1	200	B30-R10000	BBP35, BBP37, i3300, S3000, S3100
	B30-262-7569-CLP3A		105.00	155.00	1	200	B30-R10000	BBP35, BBP37, i3300, S3000, S3100
	B30-262-7569-CLP3B		105.00	155.00	1	200	B30-R10000	BBP35, BBP37, i3300, S3000, S3100
	B30-262-7569-CLP4A		105.00	155.00	1	200	B30-R10000	BBP35, BBP37, i3300, S3000, S3100
	B30-262-7569-CLP4B		105.00	155.00	1	200	B30-R10000	BBP35, BBP37, i3300, S3000, S3100
	B30-18-7569-CLP4C		76.20	25.40	1	1000	B30-R10000	BBP35, BBP37, i3300, S3000, S3100

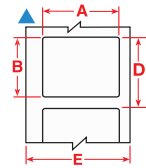

Facility and safety applications:

5S Labels, pipe markers, safety & warning labels, equipment & panel labels, arc flash & chemical labels and more!

LabelMark Upgrade Suite

Easily recreate all LabelMark functionalities with upgraded features in Brady Workstation.

For more information about the Brady Workstation Software Suites, see page 49.



B-854 and B-855 ToughWash washdown resistant labels

Withstands pressures of high heat, harsh chemicals and numerous washdown cycles

- Ideal for use in the Food & Beverage industry
- Legible and long-lasting for even the toughest washdown cycles
- B-854 offers metal detectable layer to detect foreign debris in food stream



Diagram	Order Reference		Width A (mm)	Height B (mm)	Length B (m)	Labels per Row	Labels per Roll	Recommended Ribbon	Printer compatibility
Label(s)									
⊗	B30-25-855-WARN		101.60	152.40	15.24	1	100	B30-R6000HF	BBP35, BBP37, i3300, S3000, S3100
⊗	B30-25-855-DANG		101.60	152.40	15.24	1	100	B30-R6000HF	BBP35, BBP37, i3300, S3000, S3100
⊗	B30-25-855-CAUT		101.60	152.40	15.24	1	100	B30-R6000HF	BBP35, BBP37, i3300, S3000, S3100
⊗	B30-25-854-WARN		101.60	152.40	15.24	1	100	B30-R6000HF	BBP35, BBP37, i3300, S3000, S3100
⊗	B30-25-854-DANG		101.60	152.40	15.24	1	100	B30-R6000HF	BBP35, BBP37, i3300, S3000, S3100
⊗	B30-25-854-CAUT		101.60	152.40	15.24	1	100	B30-R6000HF	BBP35, BBP37, i3300, S3000, S3100
Roll(s)									
∞	B30C-1125-855-YL		28.58	-	15.24	1	1	B30-R6000HF	BBP35, BBP37, i3300, S3000, S3100
∞	B30C-1125-855-WT		28.58	-	15.24	1	1	B30-R6000HF	BBP35, BBP37, i3300, S3000, S3100
∞	B30C-2250-855-YL		57.15	-	15.24	1	1	B30-R6000HF	BBP35, BBP37, i3300, S3000, S3100
∞	B30C-2250-855-WT		57.15	-	15.24	1	1	B30-R6000HF	BBP35, BBP37, i3300, S3000, S3100
∞	B30C-4000-855-YL		101.60	-	15.24	1	1	B30-R6000HF	BBP35, BBP37, i3300, S3000, S3100
∞	B30C-4000-855-WT		101.60	-	15.24	1	1	B30-R6000HF	BBP35, BBP37, i3300, S3000, S3100
∞	B30C-4000-854-YL		101.60	-	15.24	1	1	B30-R6000HF	BBP35, BBP37, i3300, S3000, S3100
∞	B30C-4000-854-WT		101.60	-	15.24	1	1	B30-R6000HF	BBP35, BBP37, i3300, S3000, S3100

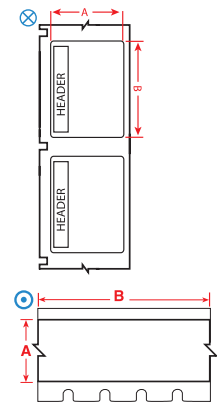

B-595 and B-7569 Pre-cut Blank labels

For general purpose, peel-off-and-apply identification

- Ideal for a wide range of labelling applications
- Includes two sizes that are pre-cut and pre-sized to fit heavy-duty rigid tags
- Indoor/Outdoor grade material



Diagram	Order Reference	Colour	Label Width A (mm)	Label Height B (mm)	Label Length B (m)	Vertical Repeat D (mm)	Labels per Roll	Printer Ribbon Series	Printer Compatibility
▲	B30-242-595-BLNKWT	White	29.00	72.00	-	82.60	300	B30-R10000	BBP35, BBP37, i3300, S3000, S3100
▲	B30-241-595-BLNKWT	White	57.00	75.00	-	82.60	300	B30-R10000	BBP35, BBP37, i3300, S3000, S3100
▲	B30-219-595-BLNKWT	White	57.00	98.00	-	108.00	250	B30-R10000	BBP35, BBP37, i3300, S3000, S3100
▲	B30-241-595-BLNKYL	Yellow	57.00	75.00	-	82.60	300	B30-R10000	BBP35, BBP37, i3300, S3000, S3100
▲	B30-25-595-BLNKWT	White	101.00	152.00	-	158.80	175	B30-R10000	BBP35, BBP37, i3300, S3000, S3100
▲	B30-25-595-BLNKYL	Yellow	101.00	152.00	-	158.80	175	B30-R10000	BBP35, BBP37, i3300, S3000, S3100
▲	B30-242-7569-WT	White	29.00	72.00	-	-	300	B30-R10000	BBP35, BBP37, i3300, S3000, S3100
▲	B30-241-7569-WT	White	57.00	75.00	-	-	300	B30-R10000	BBP35, BBP37, i3300, S3000, S3100
▲	B30-219-7569-WT	White	57.00	98.00	-	-	250	B30-R10000	BBP35, BBP37, i3300, S3000, S3100
▲	B30-241-7569-YL	Yellow	57.00	75.00	-	-	300	B30-R10000	BBP35, BBP37, i3300, S3000, S3100
▲	B30-25-7569-WT	White	101.00	152.00	-	-	175	B30-R10000	BBP35, BBP37, i3300, S3000, S3100
▲	B30-25-7569-YL	Yellow	101.00	152.00	-	-	175	B30-R10000	BBP35, BBP37, i3300, S3000, S3100

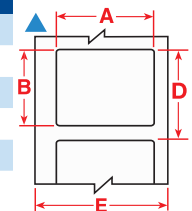

B-551 Non-adhesive continuous tag stock

For safety, lockout and general purpose hanging tags

- Non-adhesive, polyester stock
- Hole punch available separately. Order reference: 020591
- Optional snap-in grommets available. Order Reference: 020596



Diagram	Order Reference	Colour	Label Width A (mm)	Label Height B (mm)	Label Length B (m)	Vertical Repeat D (mm)	Labels per Roll	Printer Ribbon Series	Printer Compatibility
📌	B30-255-551-WT	White	82.55	146.05	-	-	100	B30-R10000	BBP35, BBP37, i3300, S3000, S3100
∞	B30C-2500-551-WT	White	64.00	-	15.24	-	1	B30-R10000	BBP35, BBP37, i3300, S3000, S3100
∞	B30C-3250-551-WT	White	83.00	-	15.24	-	1	B30-R10000	BBP35, BBP37, i3300, S3000, S3100
∞	B30C-4250-551-WT	White	108.00	-	15.24	-	1	B30-R10000	BBP35, BBP37, i3300, S3000, S3100

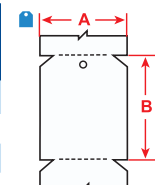

Facility & safety identification



B-584 Retro reflective tape

For Highly reflective identification that shines back brightly when struck by light

- Ideal for labelling outdoor utility poles and pedestals, jobsite equipment and roof-top equipment
- Recommended low light or inclement weather conditions

Diagram	Order Reference	Colour	Label Width A (mm)	Label Height B (mm)	Label Length B (m)	Vertical Repeat D (mm)	Labels per Roll	Printer Ribbon Series	Printer Compatibility
B-584: Reflective Tape									
∞	B30C-1125-584-OR	Orange	28.58	-	15.20	-	1	B30-R10000	BBP35, BBP37, i3300, S3000, S3100
∞	B30C-1125-584-SL	Silver	28.58	-	15.20	-	1	B30-R10000	BBP35, BBP37, i3300, S3000, S3100
∞	B30C-1125-584-YL	Yellow	28.58	-	15.20	-	1	B30-R10000	BBP35, BBP37, i3300, S3000, S3100
∞	B30C-2250-584-OR	Orange	57.15	-	15.20	-	1	B30-R10000	BBP35, BBP37, i3300, S3000, S3100
∞	B30C-2250-584-SL	Silver	57.15	-	15.20	-	1	B30-R10000	BBP35, BBP37, i3300, S3000, S3100
∞	B30C-2250-584-YL	Yellow	57.15	-	15.20	-	1	B30-R10000	BBP35, BBP37, i3300, S3000, S3100
∞	B30C-4000-584-OR	Orange	101.60	-	15.20	-	1	B30-R10000	BBP35, BBP37, i3300, S3000, S3100
∞	B30C-4000-584-SL	Silver	101.60	-	15.20	-	1	B30-R10000	BBP35, BBP37, i3300, S3000, S3100
∞	B30C-4000-584-YL	Yellow	101.60	-	15.20	-	1	B30-R10000	BBP35, BBP37, i3300, S3000, S3100

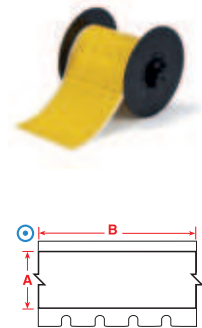

B-526 BradyGlo High-intensity photoluminescent tape

For glow-in-the dark identification - Up to 10 hours

- Designed for directional and evacuation marking
- Ideal for marking emergency utility shut-offs, fire extinguishers, alarm pulls and vital equipment controls

Diagram	Order Reference	Colour	Label Width A (mm)	Label Height B (mm)	Label Length B (m)	Vertical Repeat D (mm)	Labels per Roll	Printer Ribbon Series	Printer Compatibility
B-526: Phosphorescent Polyester									
∞	B30C-1125-526	Luminous Green	29.00	-	15.20	-	1	B30-R10000	BBP35, BBP37, i3300, S3000, S3100
∞	B30C-2250-526	Luminous Green	57.00	-	15.20	-	1	B30-R10000	BBP35, BBP37, i3300, S3000, S3100
∞	B30C-4000-526	Luminous Green	101.00	-	15.20	-	1	B30-R10000	BBP35, BBP37, i3300, S3000, S3100



B-509 Printable magnetic supply

Easiest and quickest material for removing and repositioning

- Non-adhesive magnetic material that can be printed on directly
- Ideal for reusable and repositionable identification applications

Diagram	Order Reference	Colour	Label Width A (mm)	Label Height B (mm)	Label Length B (m)	Vertical Repeat D (mm)	Labels per Roll	Printer Ribbon Series	Printer Compatibility
B-509: Magnetic Polyester									
∞	B30C-2500-509-WT	White	64.00	-	7.60	-	1	B30-R10000	BBP35, BBP37, i3300, S3000, S3100
∞	B30C-2500-509-YL	Yellow	64.00	-	7.60	-	1	B30-R10000	BBP35, BBP37, i3300, S3000, S3100
∞	B30C-4250-509-WT	White	108.00	-	7.60	-	1	B30-R10000	BBP35, BBP37, i3300, S3000, S3100
∞	B30C-4250-509-YL	Yellow	108.00	-	7.60	-	1	B30-R10000	BBP35, BBP37, i3300, S3000, S3100

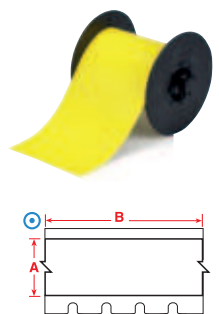

B-549 Cold temperature application material

For identification in temperature as cold as -40°C

- Special adhesive permanently adheres to extremely cold surfaces
- Ideal for cold storage warehouses, fridges, freezers and short-term outdoor use in winter
- Service temp: -40 °C to 100 °C
- Application temp: -23 °C to 100 °C

Diagram	Order Reference	Colour	Label Width A (mm)	Label Height B (mm)	Label Length B (m)	Vertical Repeat D (mm)	Labels per Roll	Printer Ribbon Series	Printer Compatibility
B-549: Polyester									
∞	B30C-1125-549-WT	White	29.00	-	30.40	-	1	B30-R10000	BBP35, BBP37, i3300, S3000, S3100
∞	B30C-1125-549-YL	Yellow	29.00	-	30.40	-	1	B30-R10000	BBP35, BBP37, i3300, S3000, S3100
∞	B30C-2250-549-WT	White	57.00	-	30.40	-	1	B30-R10000	BBP35, BBP37, i3300, S3000, S3100
∞	B30C-2250-549-YL	Yellow	57.00	-	30.40	-	1	B30-R10000	BBP35, BBP37, i3300, S3000, S3100
∞	B30C-4000-549-WT	White	101.00	-	30.40	-	1	B30-R10000	BBP35, BBP37, i3300, S3000, S3100
∞	B30C-4000-549-YL	Yellow	101.00	-	30.40	-	1	B30-R10000	BBP35, BBP37, i3300, S3000, S3100

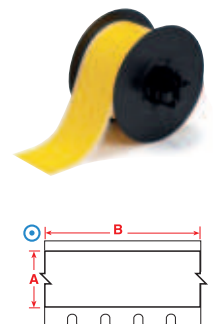

B-581 Repositionable vinyl

For 5S and lean applications

- Aggressive adhesive stays in place but removes cleanly without leaving adhesive residue
- Ideal for temporary, removable and repositionable labels, like 5S and lean inventory labels
- Service temp: -40 °C to 82 °C
- Application temp: 10 °C to 82 °C

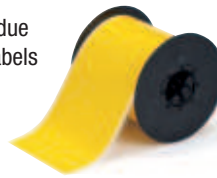
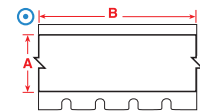

Diagram	Order Reference	Colour	Label Width A (mm)	Label Height B (mm)	Label Length B (m)	Vertical Repeat D (mm)	Labels per Roll	Printer Ribbon Series	Printer Compatibility
B-581: Vinyl									
∞	B30C-500-581-WT	White	12.50	-	30.40	-	1	B30-R10000	BBP35, BBP37, i3300, S3000, S3100
∞	B30C-500-581-YL	Yellow	12.50	-	30.40	-	1	B30-R10000	BBP35, BBP37, i3300, S3000, S3100
∞	B30C-1125-581-WT	White	29.00	-	30.40	-	1	B30-R10000	BBP35, BBP37, i3300, S3000, S3100
∞	B30C-1125-581-YL	Yellow	29.00	-	30.40	-	1	B30-R10000	BBP35, BBP37, i3300, S3000, S3100
∞	B30C-2250-581-WT	White	57.00	-	30.40	-	1	B30-R10000	BBP35, BBP37, i3300, S3000, S3100
∞	B30C-2250-581-YL	Yellow	57.00	-	30.40	-	1	B30-R10000	BBP35, BBP37, i3300, S3000, S3100
∞	B30C-4000-581-WT	White	101.00	-	30.40	-	1	B30-R10000	BBP35, BBP37, i3300, S3000, S3100
∞	B30C-4000-581-YL	Yellow	101.00	-	30.40	-	1	B30-R10000	BBP35, BBP37, i3300, S3000, S3100



Toughstripe floor marking tape

Premovable area marking tape

ToughStripe is the ideal floor marking tape in a lean environment where the regular application and replacement of floor marking is crucial.

- Superior durability
- Easy application
- High visibility
- Die-Cut shapes
- Painless Removal



Diagram	Order Reference	Colour	Label Width A (mm)	Label Height B (mm)	Label Length B (m)	Vertical Repeat D (mm)	Labels per Roll	Printer Ribbon Series	Printer Compatibility
B-483/B-634: Polyester with Polyester Overlaminat									
∞	B30C-1125-483BK-KT	Black	29.00	-	30.40	-	1	B30-R4400	BBP35, BBP37, i3300, S3000, S3100
∞	B30C-1125-483BL-KT	Blue	29.00	-	30.40	-	1	B30-R4400	BBP35, BBP37, i3300, S3000, S3100
∞	B30C-1125-483GN-KT	Green	29.00	-	30.40	-	1	B30-R4400	BBP35, BBP37, i3300, S3000, S3100
∞	B30C-1125-483OR-KT	Orange	29.00	-	30.40	-	1	B30-R6000HF	BBP35, BBP37, i3300, S3000, S3100
∞	B30C-1125-483RD-KT	Red	29.00	-	30.40	-	1	B30-R4400	BBP35, BBP37, i3300, S3000, S3100
∞	B30C-1125-483WT-KT	White	29.00	-	30.40	-	1	B30-R6000HF	BBP35, BBP37, i3300, S3000, S3100
∞	B30C-1125-483YL-KT	Yellow	29.00	-	30.40	-	1	B30-R6000HF	BBP35, BBP37, i3300, S3000, S3100
∞	B30C-2250-483BK-KT	Black	57.00	-	30.40	-	1	B30-R4400	BBP35, BBP37, i3300, S3000, S3100
∞	B30C-2250-483BL-KT	Blue	57.00	-	30.40	-	1	B30-R4400	BBP35, BBP37, i3300, S3000, S3100
∞	B30C-2250-483GN-KT	Green	57.00	-	30.40	-	1	B30-R4400	BBP35, BBP37, i3300, S3000, S3100
∞	B30C-2250-483OR-KT	Orange	57.00	-	30.40	-	1	B30-R6000HF	BBP35, BBP37, i3300, S3000, S3100
∞	B30C-2250-483RD-KT	Red	57.00	-	30.40	-	1	B30-R4400	BBP35, BBP37, i3300, S3000, S3100
∞	B30C-2250-483WT-KT	White	57.00	-	30.40	-	1	B30-R6000HF	BBP35, BBP37, i3300, S3000, S3100
∞	B30C-2250-483YL-KT	Yellow	57.00	-	30.40	-	1	B30-R6000HF	BBP35, BBP37, i3300, S3000, S3100
∞	B30C-3000-483WT-KT	White	75.00	-	30.40	-	1	B30-R6000HF	BBP35, BBP37, i3300, S3000, S3100
∞	B30C-3000-483YL-KT	Yellow	75.00	-	30.40	-	1	B30-R6000HF	BBP35, BBP37, i3300, S3000, S3100
∞	B30C-4000-483BK-KT	Black	101.00	-	30.40	-	1	B30-R4400	BBP35, BBP37, i3300, S3000, S3100
∞	B30C-4000-483BL-KT	Blue	101.00	-	30.40	-	1	B30-R4400	BBP35, BBP37, i3300, S3000, S3100
∞	B30C-4000-483GN-KT	Green	101.00	-	30.40	-	1	B30-R4400	BBP35, BBP37, i3300, S3000, S3100
∞	B30C-4000-483OR-KT	Orange	101.00	-	30.40	-	1	B30-R6000HF	BBP35, BBP37, i3300, S3000, S3100
∞	B30C-4000-483RD-KT	Red	101.00	-	30.40	-	1	B30-R4400	BBP35, BBP37, i3300, S3000, S3100
∞	B30C-4000-483WT-KT	White	101.00	-	30.40	-	1	B30-R6000HF	BBP35, BBP37, i3300, S3000, S3100
∞	B30C-4000-483YL-KT	Yellow	101.00	-	30.40	-	1	B30-R6000HF	BBP35, BBP37, i3300, S3000, S3100

Facility & safety identification



B-7569 Indoor/Outdoor vinyl

General purpose industrial vinyl for indoor/outdoor usage



- High gloss, durable and flexible identification material
- Adheres to difficult low surface energy materials
- Can handle up to 75°C, which meets industry maintenance temperatures
- Low-shrink vinyl

Diagram	Order Reference	Colour	Label Width A (mm)	Label Height B (mm)	Label Length B (m)	Vertical Repeat D (mm)	Labels per Roll	Printer Ribbon Series	Printer Compatibility
B-7569: Vinyl									
∞	B30C-500-7569-BK	Black	12.70	-	30.00	-	1	B30-R10000-WT	BBP35, BBP37, i3300, S3000, S3100
∞	B30C-500-7569-BL	Blue	12.70	-	30.00	-	1	B30-R10000-WT	BBP35, BBP37, i3300, S3000, S3100
∞	B30C-500-7569-GN	Green	12.70	-	30.00	-	1	B30-R10000-WT	BBP35, BBP37, i3300, S3000, S3100
∞	B30C-500-7569-OR	Orange	12.70	-	30.00	-	1	B30-R10000	BBP35, BBP37, i3300, S3000, S3100
∞	B30C-500-7569-RD	Red	12.70	-	30.00	-	1	B30-R10000-WT	BBP35, BBP37, i3300, S3000, S3100
∞	B30C-500-7569-WT	White	12.70	-	30.00	-	1	B30-R10000	BBP35, BBP37, i3300, S3000, S3100
∞	B30C-500-7569-YL	Yellow	12.70	-	30.00	-	1	B30-R10000	BBP35, BBP37, i3300, S3000, S3100
∞	B30C-1125-7569-BK	Black	29.00	-	30.00	-	1	B30-R10000-WT	BBP35, BBP37, i3300, S3000, S3100
∞	B30C-1125-7569-BL	Blue	29.00	-	30.00	-	1	B30-R10000-WT	BBP35, BBP37, i3300, S3000, S3100
∞	B30C-1125-7569-GN	Green	29.00	-	30.00	-	1	B30-R10000-WT	BBP35, BBP37, i3300, S3000, S3100
∞	B30C-1125-7569-OR	Orange	29.00	-	30.00	-	1	B30-R10000	BBP35, BBP37, i3300, S3000, S3100
∞	B30C-1125-7569-RD	Red	29.00	-	30.00	-	1	B30-R10000-WT	BBP35, BBP37, i3300, S3000, S3100
∞	B30C-1125-7569-WT	White	29.00	-	30.00	-	1	B30-R10000	BBP35, BBP37, i3300, S3000, S3100
∞	B30C-1125-7569-YL	Yellow	29.00	-	30.00	-	1	B30-R10000	BBP35, BBP37, i3300, S3000, S3100
∞	B30C-2250-7569-BK	Black	57.00	-	30.00	-	1	B30-R10000-WT	BBP35, BBP37, i3300, S3000, S3100
∞	B30C-2250-7569-BL	Blue	57.00	-	30.00	-	1	B30-R10000-WT	BBP35, BBP37, i3300, S3000, S3100
∞	B30C-2250-7569-GN	Green	57.00	-	30.00	-	1	B30-R10000-WT	BBP35, BBP37, i3300, S3000, S3100
∞	B30C-2250-7569-OR	Orange	57.00	-	30.00	-	1	B30-R10000	BBP35, BBP37, i3300, S3000, S3100
∞	B30C-2250-7569-RD	Red	57.00	-	30.00	-	1	B30-R10000-WT	BBP35, BBP37, i3300, S3000, S3100
∞	B30C-2250-7569-WT	White	57.00	-	30.00	-	1	B30-R10000	BBP35, BBP37, i3300, S3000, S3100
∞	B30C-2250-7569-YL	Yellow	57.00	-	30.00	-	1	B30-R10000	BBP35, BBP37, i3300, S3000, S3100
∞	B30C-3000-7569-WT	White	75.00	-	30.00	-	1	B30-R10000	BBP35, BBP37, i3300, S3000, S3100
∞	B30C-3000-7569-YL	Yellow	75.00	-	30.00	-	1	B30-R10000	BBP35, BBP37, i3300, S3000, S3100
∞	B30C-4000-7569-BK	Black	101.00	-	30.00	-	1	B30-R10000-WT	BBP35, BBP37, i3300, S3000, S3100
∞	B30C-4000-7569-BL	Blue	101.00	-	30.00	-	1	B30-R10000-WT	BBP35, BBP37, i3300, S3000, S3100
∞	B30C-4000-7569-GN	Green	101.00	-	30.00	-	1	B30-R10000-WT	BBP35, BBP37, i3300, S3000, S3100
∞	B30C-4000-7569-OR	Orange	101.00	-	30.00	-	1	B30-R10000	BBP35, BBP37, i3300, S3000, S3100
∞	B30C-4000-7569-RD	Red	101.00	-	30.00	-	1	B30-R10000-WT	BBP35, BBP37, i3300, S3000, S3100
∞	B30C-4000-7569-WT	White	101.00	-	30.00	-	1	B30-R10000	BBP35, BBP37, i3300, S3000, S3100
∞	B30C-4000-7569-YL	Yellow	101.00	-	30.00	-	1	B30-R10000	BBP35, BBP37, i3300, S3000, S3100

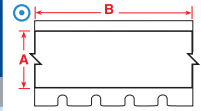

B-787 Polyvinyl fluoride tape

Ideal for applications where self-extinguishing properties are required

Polyvinylfluoride (B-787) tape is ideal for label applications where self-extinguishing properties are required.

Glossy white topcoated material with permanent acrylic adhesive

Meets the colour requirements of FED-STD-595C Colour 17875 White and complies with the requirements of Boeing BMS 10-26 Type I, Grade A



Diagram	Order Reference	Colour	Label Width A (mm)	Label Height B (mm)	Label Length B (m)	Vertical Repeat D (mm)	Labels per Roll	Printer Ribbon Series	Printer Compatibility
B-787: Polyvinylfluoride									
⊙	B30C-4000-787	White	101.00	-	18.29	-	1	B30-R6000	BBP35, BBP37, i3300, S3000, S3100

B-593 Raised profile labels - Push button style

Lower cost than engraved legend plates

- High gloss, polyester label with thick raised profile and ultra-aggressive adhesive (total thickness = 0.65 mm)
- High performance, low cost substitute to engraved plates
- 10 year outdoor durability rating
- On-demand labelling: labels print out in less than 4 seconds
- 5 push button sizes (including keyed with 22.50 and 30.50 mm hole diam and non-keyed with 22.50 mm hole diam)



Diagram	Order Reference	Colour	Label Width A (mm)	Label Height B (mm)	Vertical Repeat D (mm)	Labels per Roll	Printer Ribbon Series	Printer Compatibility
B-593: Polyester								
	B30EP-167-593-BK	Black	38.10	30.48	44.50	200	B30-R4400-WT	BBP35, BBP37, i3300, S3000, S3100
	B30EP-167-593-GN	Green	38.10	30.48	44.50	200	B30-R4400-WT	BBP35, BBP37, i3300, S3000, S3100
	B30EP-167-593-RD	Red	38.10	30.48	44.50	200	B30-R4400-WT	BBP35, BBP37, i3300, S3000, S3100
	B30EP-167-593-WT	White	38.10	30.48	44.50	200	B30-R6000HF	BBP35, BBP37, i3300, S3000, S3100
	B30EP-167-593-YL	Yellow	38.10	30.48	44.50	200	B30-R6000HF	BBP35, BBP37, i3300, S3000, S3100
	B30EP-167U-593-BK	Black	38.10	30.48	44.50	200	B30-R4400-WT	BBP35, BBP37, i3300, S3000, S3100
	B30EP-167U-593-GN	Green	38.10	30.48	44.50	200	B30-R4400-WT	BBP35, BBP37, i3300, S3000, S3100
	B30EP-167U-593-RD	Red	38.10	30.48	44.50	200	B30-R4400-WT	BBP35, BBP37, i3300, S3000, S3100
	B30EP-167U-593-WT	White	38.10	30.48	44.50	200	B30-R6000HF	BBP35, BBP37, i3300, S3000, S3100
	B30EP-167U-593-YL	Yellow	38.10	30.48	44.50	200	B30-R6000HF	BBP35, BBP37, i3300, S3000, S3100
	B30EP-168-593-BK	Black	48.26	30.48	54.00	180	B30-R4400-WT	BBP35, BBP37, i3300, S3000, S3100
	B30EP-168-593-GN	Green	48.26	30.48	54.00	180	B30-R4400-WT	BBP35, BBP37, i3300, S3000, S3100
	B30EP-168-593-RD	Red	48.26	30.48	54.00	180	B30-R4400-WT	BBP35, BBP37, i3300, S3000, S3100
	B30EP-168-593-WT	White	48.26	30.48	54.00	180	B30-R6000HF	BBP35, BBP37, i3300, S3000, S3100
	B30EP-168-593-YL	Yellow	48.26	30.48	54.00	180	B30-R6000HF	BBP35, BBP37, i3300, S3000, S3100
	B30EP-169-593-BK	Black	45.72	45.72	50.80	190	B30-R4400-WT	BBP35, BBP37, i3300, S3000, S3100
	B30EP-169-593-GN	Green	45.72	45.72	50.80	190	B30-R4400-WT	BBP35, BBP37, i3300, S3000, S3100
	B30EP-169-593-RD	Red	45.72	45.72	50.80	190	B30-R4400-WT	BBP35, BBP37, i3300, S3000, S3100
	B30EP-169-593-WT	White	45.72	45.72	50.80	190	B30-R6000HF	BBP35, BBP37, i3300, S3000, S3100
	B30EP-169-593-YL	Yellow	45.72	45.72	50.80	190	B30-R6000HF	BBP35, BBP37, i3300, S3000, S3100
	B30EP-170-593-BK	Black	60.96	60.96	66.70	145	B30-R4400-WT	BBP35, BBP37, i3300, S3000, S3100
	B30EP-170-593-GN	Green	60.96	60.96	66.70	145	B30-R4400-WT	BBP35, BBP37, i3300, S3000, S3100
	B30EP-170-593-RD	Red	60.96	60.96	66.70	145	B30-R4400-WT	BBP35, BBP37, i3300, S3000, S3100
	B30EP-170-593-WT	White	60.96	60.96	66.70	145	B30-R6000HF	BBP35, BBP37, i3300, S3000, S3100
	B30EP-170-593-YL	Yellow	60.96	60.96	66.70	145	B30-R6000HF	BBP35, BBP37, i3300, S3000, S3100

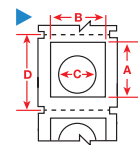
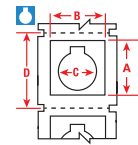

B-593 Raised profile labels

Lower cost than engraved legend plates

- High gloss, polyester label with thick raised profile and ultra-aggressive adhesive (0.65 mm)
- Ideal for inside-panel backer board labels and front-of-enclosure labelling
- On-demand labelling: labels print out in less than 4 seconds
- No need to abbreviate your text to avoid per character engraving charges
- 10-year outdoor durability rating
- 6 colours, 7 rectangular sizes

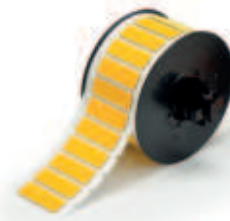
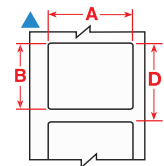

Diagram	Order Reference	Colour	Label Width A (mm)	Label Height B (mm)	Vertical Repeat D (mm)	Labels per Roll	Printer Ribbon Series	Printer Compatibility
B-593: Polyester								
	B30EP-171-593-BK	Black	26.92	12.70	19.10	500	B30-R4400-WT	BBP35, BBP37, i3300, S3000, S3100
	B30EP-171-593-GN	Green	26.92	12.70	19.10	500	B30-R4400-WT	BBP35, BBP37, i3300, S3000, S3100
	B30EP-171-593-RD	Red	26.92	12.70	19.10	500	B30-R4400-WT	BBP35, BBP37, i3300, S3000, S3100
	B30EP-171-593-SL	Silver	26.92	12.70	19.10	500	B30-R6000HF	BBP35, BBP37, i3300, S3000, S3100
	B30EP-171-593-WT	White	26.92	12.70	19.10	500	B30-R6000HF	BBP35, BBP37, i3300, S3000, S3100
	B30EP-171-593-YL	Yellow	26.92	12.70	19.10	500	B30-R6000HF	BBP35, BBP37, i3300, S3000, S3100
	B30EP-172-593-BK	Black	44.99	14.99	21.60	450	B30-R4400-WT	BBP35, BBP37, i3300, S3000, S3100
	B30EP-172-593-GN	Green	44.99	14.99	21.60	450	B30-R4400-WT	BBP35, BBP37, i3300, S3000, S3100
	B30EP-172-593-RD	Red	44.99	14.99	21.60	450	B30-R4400-WT	BBP35, BBP37, i3300, S3000, S3100
	B30EP-172-593-SL	Silver	44.99	14.99	21.60	450	B30-R6000HF	BBP35, BBP37, i3300, S3000, S3100
	B30EP-172-593-WT	White	44.99	14.99	21.60	450	B30-R6000HF	BBP35, BBP37, i3300, S3000, S3100



>>



B-593 Raised profile labels (Continued)

Lower cost than engraved legend plates

Diagram	Order Reference	Colour	Label Width A (mm)	Label Height B (mm)	Vertical Repeat D (mm)	Labels per Roll	Printer Ribbon Series	Printer Compatibility
▲	B30EP-172-593-YL	Yellow	44.99	14.99	21.60	450	B30-R6000HF	BBP35, BBP37, i3300, S3000, S3100
▲	B30EP-173-593-BK	Black	50.80	25.40	31.80	300	B30-R4400-WT	BBP35, BBP37, i3300, S3000, S3100
▲	B30EP-173-593-GN	Green	50.80	25.40	31.80	300	B30-R4400-WT	BBP35, BBP37, i3300, S3000, S3100
▲	B30EP-173-593-RD	Red	50.80	25.40	31.80	300	B30-R4400-WT	BBP35, BBP37, i3300, S3000, S3100
▲	B30EP-173-593-SL	Silver	50.80	25.40	31.80	300	B30-R6000HF	BBP35, BBP37, i3300, S3000, S3100
▲	B30EP-173-593-WT	White	50.80	25.40	31.80	300	B30-R6000HF	BBP35, BBP37, i3300, S3000, S3100
▲	B30EP-173-593-YL	Yellow	50.80	25.40	31.80	300	B30-R6000HF	BBP35, BBP37, i3300, S3000, S3100
▲	B30EP-174-593-BK	Black	101.60	25.40	31.80	300	B30-R4400-WT	BBP35, BBP37, i3300, S3000, S3100
▲	B30EP-174-593-GN	Green	101.60	25.40	31.80	300	B30-R4400-WT	BBP35, BBP37, i3300, S3000, S3100
▲	B30EP-174-593-RD	Red	101.60	25.40	31.80	300	B30-R4400-WT	BBP35, BBP37, i3300, S3000, S3100
▲	B30EP-174-593-SL	Silver	101.60	25.40	31.80	300	B30-R6000HF	BBP35, BBP37, i3300, S3000, S3100
▲	B30EP-174-593-WT	White	101.60	25.40	31.80	300	B30-R6000HF	BBP35, BBP37, i3300, S3000, S3100
▲	B30EP-174-593-YL	Yellow	101.60	25.40	31.80	300	B30-R6000HF	BBP35, BBP37, i3300, S3000, S3100
▲	B30EP-175-593-BK	Black	76.20	19.05	25.40	375	B30-R4400-WT	BBP35, BBP37, i3300, S3000, S3100
▲	B30EP-175-593-GN	Green	76.20	19.05	25.40	375	B30-R4400-WT	BBP35, BBP37, i3300, S3000, S3100
▲	B30EP-175-593-WT	White	76.20	19.05	25.40	375	B30-R6000HF	BBP35, BBP37, i3300, S3000, S3100
▲	B30EP-175-593-YL	Yellow	76.20	19.05	25.40	375	B30-R6000HF	BBP35, BBP37, i3300, S3000, S3100
▲	B30EP-176-593-BK	Black	76.20	25.40	31.80	300	B30-R4400-WT	BBP35, BBP37, i3300, S3000, S3100
▲	B30EP-176-593-GN	Green	76.20	25.40	31.80	300	B30-R4400-WT	BBP35, BBP37, i3300, S3000, S3100
▲	B30EP-176-593-WT	White	76.20	25.40	31.80	300	B30-R6000HF	BBP35, BBP37, i3300, S3000, S3100
▲	B30EP-176-593-YL	Yellow	76.20	25.40	31.80	300	B30-R6000HF	BBP35, BBP37, i3300, S3000, S3100
▲	B30EP-177-593-BK	Black	76.20	63.50	69.90	125	B30-R4400-WT	BBP35, BBP37, i3300, S3000, S3100
▲	B30EP-177-593-GN	Green	76.20	63.50	69.90	125	B30-R4400-WT	BBP35, BBP37, i3300, S3000, S3100
▲	B30EP-177-593-WT	White	76.20	63.50	69.90	125	B30-R6000HF	BBP35, BBP37, i3300, S3000, S3100
▲	B30EP-177-593-YL	Yellow	76.20	63.50	69.90	125	B30-R6000HF	BBP35, BBP37, i3300, S3000, S3100

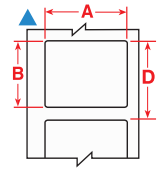

Inside-panel component labels

For automation & electrical panels and enclosures

- Various sizes in several durable material types
- Ideal for marking backer board, DIN rail, relays, PLCs, switches, solenoids, drive motors and other components
- All recommended materials are flexible and have high-tack adhesives for adhesion to wide variety of surfaces and components

Diagram	Order Reference	Colour	Label Width A (mm)	Label Height B (mm)	Vertical Repeat D (mm)	Labels per Roll	Printer Ribbon Series	Printer Compatibility
B-422: Polyester								
⊙	B33C-375-422	White	9.53	—	—	1	B30-R6000HF	i3300
B-483: Polyester								
⬢	B33-149-483	White	12.70	12.70	15.20	5000	B30-R6000HF	i3300
⬢	B33-5-483	White	25.40	12.70	15.24	5000	B30-R6000HF	i3300
▲	B33-7-483	White	31.75	69.85	34.90	1000	B30-R6000HF	i3300
▲	B33-17-483	White	50.80	25.40	28.60	1500	B30-R6000HF	i3300
▲	B33-55-483	White	50.80	101.60	54.00	750	B30-R6000HF	i3300
▲	B33-18-483	White	76.20	25.40	28.60	1500	B30-R6000HF	i3300
▲	B33-19-483	White	76.20	50.80	54.00	500	B30-R6000HF	i3300
B-484A: Polyester								
▲	B33-125-484	White	22.86	12.70	15.20	1500	B30-R6000HF	i3300
▲	B33-17-484	White	25.40	50.80	28.60	1500	B30-R6000HF	i3300
▲	B33-18-484	White	25.40	76.20	28.60	1500	B30-R6000HF	i3300
⬢	B33-5-484	White	25.40	12.70	15.20	5000	B30-R6000HF	i3300
▲	B33-19-484	White	50.80	76.20	54.00	500	B30-R6000HF	i3300
▲	B33-136-484	White	38.10	19.05	22.23	1500	B30-R6000HF	i3300
B-498: Vinyl Cloth								
⬢	B33-90-498	White	6.35	36.50	39.70	2500	B30-R6200	i3300
⬢	B33-68-498	White	12.70	19.05	22.20	5000	B30-R6200	i3300

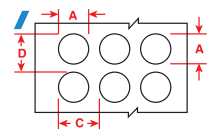
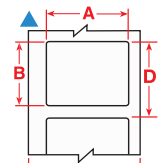
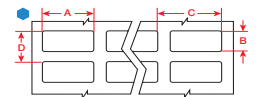
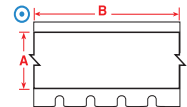

>>

Inside-panel component labels (Continued)

For automation & electrical panels and enclosures

Diagram	Order Reference	Colour	Label Width A (mm)	Label Height B (mm)	Vertical Repeat D (mm)	Labels per Roll	Printer Ribbon Series	Printer Compatibility
B-498: Vinyl Cloth								
⬢	B33-87-498	White	12.70	36.50	39.70	2500	B30-R6200	i3300
⬢	B33-1-498	White	19.05	6.35	8.90	5000	B30-R6200	i3300
⬢	B33-95-498	White	20.32	36.50	39.70	2300	B30-R6200	i3300
⬢	B33-5-498	White	25.40	12.70	15.24	5000	B30-R6200	i3300
⬢	B33-88-498	White	25.40	19.05	22.23	2500	B30-R6200	i3300
⬢	B33-89-498	White	25.40	36.50	39.70	2300	B30-R6200	i3300
B-499: Nylon Cloth								
/	B33-143-499	White	–	–	12.70	1500	B30-R6000HF	i3300
/	B33-144-499	White	–	–	15.90	1500	B30-R6000HF	i3300
/	B33-602-499	White	–	–	16.50	3000	B30-R6000HF	i3300
/	B33-602-499YL	Yellow	–	–	16.50	3000	B30-R6000HF	i3300
/	B33-603-499	White	–	–	15.70	3000	B30-R6000HF	i3300
/	B33-603-499YL	Yellow	–	–	15.70	3000	B30-R6000HF	i3300
⬢	B33-68-499	White	12.70	19.05	22.20	1500	B30-R6000HF	i3300
⬢	B33-165-499	White	20.32	36.50	39.70	2500	B30-R6000HF	i3300
▲	B33-125-499	White	22.86	12.70	15.24	1500	B30-R6000HF	i3300
⬢	B33-152-499	White	25.40	9.53	12.07	1500	B30-R6000HF	i3300
▲	B33-151-499	White	50.80	6.35	8.89	1500	B30-R6000HF	i3300
▲	B33-136-499	White	38.10	19.05	22.23	1500	B30-R6000HF	i3300
B-593: Polyester								
▲	B30EP-171-593-BK	Black	26.92	12.70	19.10	500	B30-R4400-WT	BBP35, BBP37, i3300, S3000, S3100
▲	B30EP-171-593-SL	Silver	26.92	12.70	19.10	500	B30-R6000HF	BBP35, BBP37, i3300, S3000, S3100
▲	B30EP-171-593-WT	White	26.92	12.70	19.10	500	B30-R6000HF	BBP35, BBP37, i3300, S3000, S3100
B-595: Vinyl								
∞	B30C-500-595-WT	White	12.70	–	–	1	B30-R10000	BBP35, BBP37, i3300, S3000, S3100
∞	B30C-500-595-YL	Yellow	12.70	–	–	1	B30-R10000	BBP35, BBP37, i3300, S3000, S3100

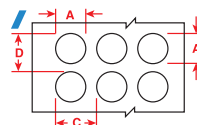
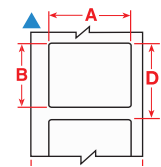
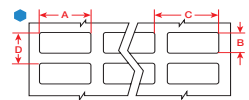
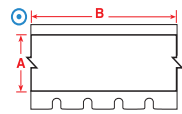

B-427 Self-laminating wire & cable markers

Brady's most popular wire marker

- Features white printable area with clear "tail" that wraps around marker to protect text
- Superior resistance to abrasion, handling, solvents, water, oil and dirt
- Permanent acrylic adhesive designed specifically for tightly curved surfaces

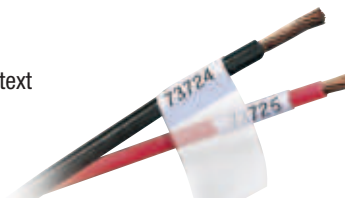
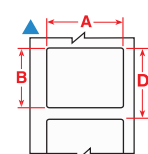
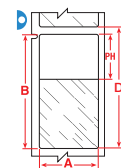
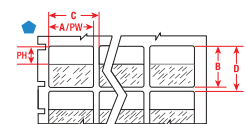
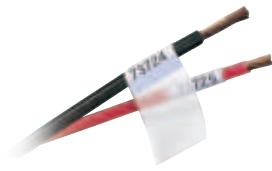

Diagram	Order Reference	Colour	Label Width A (mm)	Label Height B (mm)	Vertical Repeat D (mm)	Labels per Roll	Printer Ribbon Series	Printer Compatibility
B-427: Self-laminating Vinyl								
⬢	B33-10-427	White/Transparent	25.40	95.25	101.60	1200	B30-R4300	i3300
⬢	B33-113-427	White/Transparent	12.70	25.40	28.60	2500	B30-R4300	i3300
⬢	B33-115-427	White/Transparent	25.40	19.05	22.20	2500	B30-R4300	i3300
⬢	B33-116-427	White/Transparent	25.40	25.40	28.60	2500	B30-R4300	i3300
⬢	B33-118-427	White/Transparent	38.10	25.40	28.60	1250	B30-R4300	i3300
⬢	B33-119-427	White/Transparent	38.10	38.10	41.30	1000	B30-R4300	i3300
⬢	B33-120-427	White/Transparent	44.45	25.40	28.60	1250	B30-R4300	i3300
⬢	B33-121-427	White/Transparent	44.45	38.10	41.30	1000	B30-R4300	i3300
⬢	B33-131-427	White/Transparent	66.68	25.40	28.60	1500	B30-R4300	i3300
▲	B33-135-427AW*	White	38.10	19.05	22.22	1500	B30-R4300	i3300
▲	B33-137-427AW*	White	50.80	25.40	28.58	1500	B30-R4300	i3300
⬢	B33-211-427	White/Transparent	25.40	25.40	32.13	3000	B30-R4300	i3300
⬢	B33-26-427	White/Transparent	63.50	57.15	61.90	500	B30-R4300	i3300
⬢	B33-272-427	White/Transparent	38.10	57.15	63.50	700	B30-R4300	i3300
⬢	B33-273-427	White/Transparent	44.45	57.15	63.50	500	B30-R4300	i3300





B-427 Self-laminating wire & cable markers (Continued)

Brady's most popular wire marker

Diagram	Order Reference	Colour	Label Width A (mm)	Label Height B (mm)	Vertical Repeat D (mm)	Labels per Roll	Printer Ribbon Series	Printer Compatibility
	B33-27-427	White/Transparent	50.80	95.25	101.60	400	B30-R4300	i3300
	B33-311-427	White/Transparent	25.40	31.75	37.72	3000	B30-R4300	i3300
	B33-511-427	White/Transparent	25.40	63.50	70.64	1500	B30-R4300	i3300
	B33-517-427	White/Transparent	38.10	63.50	69.85	1000	B30-R4300	i3300
	B33-56-427	White/Transparent	19.05	23.81	28.60	5000	B30-R4300	i3300
	B33-640-427AW*	White	55.88	38.10	45.08	1500	B30-R4300	i3300
	B33-648-427AW*	White	66.68	25.40	32.38	1500	B30-R4300	i3300
	B33-73-427	White/Transparent	19.05	44.45	47.60	3500	B30-R4300	i3300
	B33-74-427	White/Transparent	20.32	36.50	41.30	4000	B30-R4300	i3300
	B33-75-427	White/Transparent	25.40	57.15	60.30	1400	B30-R4300	i3300
	B33-80-427	White/Transparent	12.70	19.05	24.10	2500	B30-R4300	i3300
	B33-81-427	White/Transparent	25.40	152.40	157.10	500	B30-R4300	i3300
	B33-82-427	White/Transparent	50.80	152.40	157.15	200	B30-R4300	i3300
	B33-8-427	White/Transparent	12.70	36.50	41.30	5000	B30-R4300	i3300
	B33-9-427	White/Transparent	25.40	36.50	41.30	2500	B30-R4300	i3300

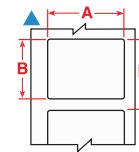
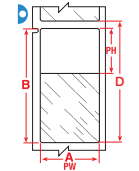
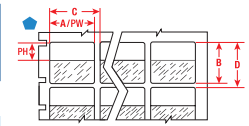

*AW = All white / no transparent area



B-425 Fibre optic labels

Ideal for marking fibre optic cables

- Allows you to handle and view labels without touching the wires.

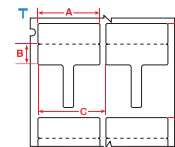
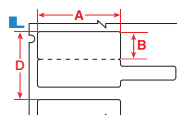
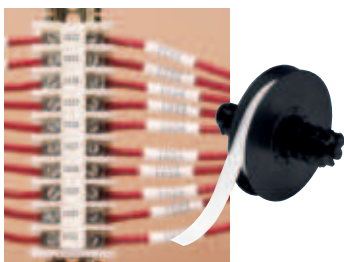

Diagram	Order Reference	Colour	Label Width A (mm)	Label Height B (mm)	Vertical Repeat D (mm)	Labels per Roll	Printer Ribbon Series	Printer Compatibility
B-425: Polypropylene								
	B33FP-01-425	White	30.00	10.00	26.03	1000	B30-R4300	i3300
	B33FT-01-425	White	30.00	10.00	46.03	1000	B30-R4300	i3300



B-498 Adhesive terminal block markers

Holds strong but can be removed cleanly and re-applied

- Specially designed narrow-width continuous label for alignment on terminal blocks and patch panels
- Highly unique adhesive and cloth construction gives excellent holding power and still allows for clean removal and re-application

Diagram	Order Reference	Colour	Label Width A (mm)	Label Height B (mm)	Label Length B (m)	Vertical Repeat D (mm)	Labels per Roll	Printer Ribbon Series	Printer Compatibility
B-498: Vinyl Cloth									
	B33C-312-498	White	7.92	-	25.91 m	-	1	B30-R6200	i3300
	B33C-375-498	White	9.53	-	25.91 m	-	1	B30-R6200	i3300

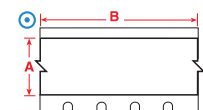

B-498 Repositionable vinyl cloth wire & cable markers

Holds strong but can be removed cleanly and re-applied

- A vinyl cloth label for marking wires, cables and inside-panel components
- Highly unique adhesive and cloth construction gives excellent holding power and still allows for clean removal and re-application
- Ideal choice for marking both ends of a wire that you may need to cut shorted before final termination



Diagram	Order Reference	Colour	Label Width A (mm)	Label Height B (mm)	Vertical Repeat D (mm)	Labels per Roll	Printer Ribbon Series	Printer Compatibility
B-498: Vinyl Cloth								
●	B33-1-498	White	19.05	6.35	8.90	5000	B30-R6200	i3300
●	B33-5-498	White	25.40	12.70	15.24	5000	B30-R6200	i3300
●	B33-68-498	White	12.70	19.05	22.20	5000	B30-R6200	i3300
●	B33-87-498	White	12.70	36.50	39.70	2500	B30-R6200	i3300
●	B33-88-498	White	25.40	19.05	22.23	2500	B30-R6200	i3300
●	B33-89-498	White	25.40	36.50	39.70	2300	B30-R6200	i3300
●	B33-90-498	White	6.35	36.50	39.70	2500	B30-R6200	i3300
●	B33-91-498	White	19.05	23.80	27.00	2500	B30-R6200	i3300
●	B33-95-498	White	20.32	36.50	39.70	2300	B30-R6200	i3300

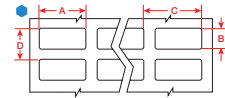

B-499 Wire & cable markers

This nylon cloth material has superb adhesive power, making it a flexible all surfaces solution



Diagram	Order Reference	Colour	Label Width A (mm)	Label Height B (mm)	Vertical Repeat D (mm)	Labels per Roll	Printer Ribbon Series	Printer Compatibility
B-499: Nylon Cloth								
▲	B33-125-499	White	22.86	12.70	15.24	1500	B30-R6000HF	i3300
⊠	B33-126-499	White	22.86	12.70	15.24	1500	B30-R6000HF	i3300
▲	B33-151-499	White	50.80	6.35	8.89	1500	B30-R6000HF	i3300
●	B33-152-499	White	25.40	9.53	12.07	1500	B30-R6000HF	i3300
⊠	B33-163-499	White	25.40	9.53	12.70	1500	B30-R6000HF	i3300
●	B33-611-499	White	12.70	25.40	28.40	3000	B30-R6000HF	i3300
▲	B33-620-499	White	12.70	25.40	28.40	1000	B30-R6000HF	i3300
●	B33-621-499	White	25.40	36.50	39.50	3000	B30-R6000HF	i3300
●	B33-625-499	White	25.40	66.68	69.68	1500	B30-R6000HF	i3300
▲	B33-659-499	White	25.40	12.40	15.40	1000	B30-R6000HF	i3300

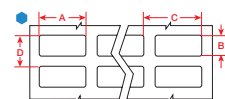
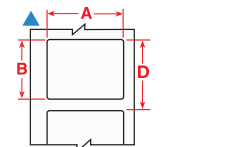



B-437 Tedlar adhesive wire & cable labels

Topcoated Polyvinylfluoride label for wire & cable marking where high temperature and self-extinguishing features are required

- Heavy duty performance with excellent resistance to water, oil and other fluids
- Meets MIL-M-87958 Standard

Diagram	Order Reference	Colour	Label Width, A (mm)	Label Height, B (mm)	Vertical Repeat D (mm)	Labels per Roll	Printer, Ribbon Series	Printer Compatibility
B-437: Polyvinylfluoride								
⊙	B30C-4000-437	White	101.00	–	–	1	B30-R-4300	BBP35, BBP37, i3300, S3000, S3100
⊙	B33-11-437	White	6.35	6.35	9.50	15000	B30-R4300	i3300
⊙	B33-1-437	White	19.05	6.35	8.90	5000	B30-R4300	i3300
⊙	B33-2-437	White	22.86	6.35	8.90	5000	B30-R4300	i3300
⊙	B33-29-437	White	31.75	9.53	12.10	5000	B30-R4300	i3300
⊙	B33-29-437YL	Yellow	31.75	9.53	12.10	5000	B30-R4300	i3300
⊙	B33-5-437	White	25.40	12.70	15.20	5000	B30-R4300	i3300
⊙	B33-5-437YL	Yellow	25.40	12.70	15.20	5000	B30-R4300	i3300
⊙	B33C-1000-437	White	25.40	–	–	1	B30-R4300	i3300
⊙	B33C-1000-437YL	Yellow	25.40	–	–	1	B30-R4300	i3300
⊙	B33C-1500-437	White	38.10	–	–	1	B30-R4300	i3300
⊙	B33C-1500-437YL	Yellow	38.10	–	–	1	B30-R4300	i3300
⊙	B33C-2000-437	White	50.80	–	–	1	B30-R4300	i3300
⊙	B33C-2000-437YL	Yellow	50.80	–	–	1	B30-R4300	i3300
⊙	B33C-3000-437	White	76.20	–	–	1	B30-R4300	i3300
⊙	B33C-3000-437YL	Yellow	76.20	–	–	1	B30-R4300	i3300

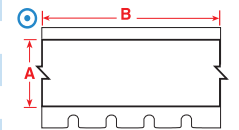
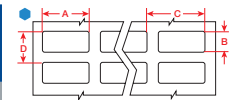

B-472 Polyimide high temp adhesive wire & cable labels

Topcoated Polyimide label for wire & cable marking where high temperature and self-extinguishing features are required

- Heavy duty performance with excellent resistance to water, oil and other fluids

Diagram	Order Reference	Colour	Label Width A (mm)	Label Height B (mm)	Vertical Repeat D (mm)	Labels per Roll	Printer Ribbon Series	Printer Compatibility
B-472: Polyimide								
⊙	B33-11-472	White	6.35	6.35	9.50	15000	B30-R4300	i3300
⊙	B33-1-472	White	19.05	6.35	8.90	5000	B30-R4300	i3300
⊙	B33-2-472	White	22.86	6.35	8.90	5000	B30-R4300	i3300
⊙	B33-29-472	White	31.75	9.53	12.10	5000	B30-R4300	i3300
⊙	B33-29-472YL	Yellow	31.75	9.53	12.10	5000	B30-R4300	i3300
⊙	B33-5-472	White	25.40	12.70	15.20	5000	B30-R4300	i3300
⊙	B33-5-472YL	Yellow	25.40	12.70	15.20	5000	B30-R4300	i3300
⊙	B33C-1000-472	White	25.40	–	–	1	B30-R4300	i3300
⊙	B33C-1000-472YL	Yellow	25.40	–	–	1	B30-R4300	i3300
⊙	B33C-1500-472	White	38.10	–	–	1	B30-R4300	i3300
⊙	B33C-1500-472YL	Yellow	38.10	–	–	1	B30-R4300	i3300
⊙	B33C-2000-472	White	50.80	–	–	1	B30-R4300	i3300
⊙	B33C-2000-472YL	Yellow	50.80	–	–	1	B30-R4300	i3300
⊙	B33C-3000-472	White	76.20	–	–	1	B30-R4300	i3300
⊙	B33C-3000-472YL	Yellow	76.20	–	–	1	B30-R4300	i3300

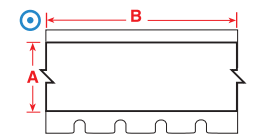
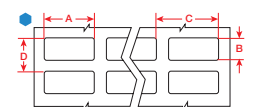

B-7599 Polyethylene tag

Rapido wire marking sleeves

Diagram	Order Reference	Colour	Label Width A (mm)	Label Height B (mm)	Vertical Repeat D (mm)	Labels per Roll	Printer Ribbon Series	Printer Compatibility
B-7599: Polyethylene Tag								
	B33R-01-7599-YL	Yellow	22.90	5.20	8.39	2500	B30-R4300, B30-R6200	i3300
	B33R-02-7599-YL	Yellow	23.00	5.20	8.39	2500	B30-R4300, B30-R6200	i3300
	B33R-03-7599-YL	Yellow	25.00	5.70	8.89	2500	B30-R4300, B30-R6200	i3300



B-7597 Tear resistant tags

This tag can be used for a variety of applications including identification of multi-conductor cables, inventory and equipment

Diagram	Order Reference	Colour	Label Width A (mm)	Label Height B (mm)	Vertical Repeat D (mm)	Labels per Roll	Printer Ribbon Series	Printer Compatibility
B-7597: Polyethylene Tag								
	B33-7597W-2050	White	50.80	12.70	16.72	2000	B30-R4300	i3300

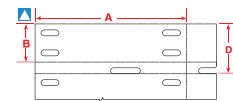

B-7598 Polyester cable tag

Durable outdoor cable identification

Diagram	Order Reference	Colour	Label Width A (mm)	Label Height B (mm)	Vertical Repeat D (mm)	Labels per Roll	Printer Ribbon Series	Printer Compatibility
B-7598: Polyester Tag								
	B33-60x10-7598-BK	Black	60.00	10.00	15.08	1000	B30-R4400-WT	i3300
	B33-60x10-7598-BL	Blue	60.00	10.00	15.08	1000	B30-R6000	i3300
	B33-60x10-7598-GN	Green	60.00	10.00	15.08	1000	B30-R6000	i3300
	B33-60x10-7598-RD	Red	60.00	10.00	15.08	1000	B30-R6000	i3300
	B33-60x10-7598-SV	Silver	60.00	10.00	15.08	1000	B30-R6000	i3300
	B33-60x10-7598-WT	White	60.00	10.00	15.08	1000	B30-R6000	i3300
	B33-60x10-7598-YL	Yellow	60.00	10.00	15.08	1000	B30-R6000	i3300
	B33-75x10-7598-BK	Black	75.00	10.00	15.08	1000	B30-R4400-WT	i3300
	B33-75x10-7598-BL	Blue	75.00	10.00	15.08	1000	B30-R6000	i3300
	B33-75x10-7598-GN	Green	75.00	10.00	15.08	1000	B30-R6000	i3300
	B33-75x10-7598-RD	Red	75.00	10.00	15.08	1000	B30-R6000	i3300
	B33-75x10-7598-SV	Silver	75.00	10.00	15.08	1000	B30-R6000	i3300
	B33-75x10-7598-WT	White	75.00	10.00	15.08	1000	B30-R6000	i3300
	B33-75x10-7598-YL	Yellow	75.00	10.00	15.08	1000	B30-R6000	i3300
	B33-75x15-7598-BK	Black	75.00	15.00	20.02	1000	B30-R4400-WT	i3300
	B33-75x15-7598-BL	Blue	75.00	15.00	20.02	1000	B30-R6000	i3300
	B33-75x15-7598-GN	Green	75.00	15.00	20.02	1000	B30-R6000	i3300
	B33-75x15-7598-RD	Red	75.00	15.00	20.02	1000	B30-R6000	i3300
	B33-75x15-7598-SV	Silver	75.00	15.00	20.02	1000	B30-R6000	i3300
	B33-75x15-7598-WT	White	75.00	15.00	20.02	1000	B30-R6000	i3300
	B33-75x15-7598-YL	Yellow	75.00	15.00	20.02	1000	B30-R6000	i3300
	B33-75x25-7598-BK	Black	75.00	25.00	30.16	500	B30-R4400-WT	i3300
	B33-75x25-7598-BL	Blue	75.00	25.00	30.16	500	B30-R6000	i3300
	B33-75x25-7598-GN	Green	75.00	25.00	30.16	500	B30-R6000	i3300
	B33-75x25-7598-RD	Red	75.00	25.00	30.16	500	B30-R6000	i3300
	B33-75x25-7598-SV	Silver	75.00	25.00	30.16	500	B30-R6000	i3300
	B33-75x25-7598-WT	White	75.00	25.00	30.16	500	B30-R6000	i3300
	B33-75x25-7598-YL	Yellow	75.00	25.00	30.16	500	B30-R6000	i3300

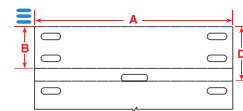



B-7643 Halogen-free cable tag

Easily print cable tags wherever you are



Diagram	Order Reference	Colour	Label Width A (mm)	Label Height B (mm)	Vertical Repeat D (mm)	Labels per Roll	Printer Ribbon Series	Printer Compatibility
B-7643: Thermoplastic Polyether Polyurethane								
	B33-60x10-7643-BK	Black	60.00	10.00	15.08	750	B30-R4400-WT	i3300
	B33-60x10-7643-BL	Blue	60.00	10.00	15.08	750	B30-R6000HF	i3300
	B33-60x10-7643-GN	Green	60.00	10.00	15.08	750	B30-R6000HF	i3300
	B33-60x10-7643-OR	Orange	60.00	10.00	15.08	750	B30-R6000HF	i3300
	B33-60x10-7643-RD	Red	60.00	10.00	15.08	750	B30-R6000HF	i3300
	B33-60x10-7643-YL	Yellow	60.00	10.00	15.08	750	B30-R6000HF	i3300
	B33-75x10-7643-BK	Black	75.00	10.00	15.08	750	B30-R4400-WT	i3300
	B33-75x10-7643-BL	Blue	75.00	10.00	15.08	750	B30-R6000HF	i3300
	B33-75x10-7643-GN	Green	75.00	10.00	15.08	750	B30-R6000HF	i3300
	B33-75x10-7643-OR	Orange	75.00	10.00	15.08	750	B30-R6000HF	i3300
	B33-75x10-7643-RD	Red	75.00	10.00	15.08	750	B30-R6000HF	i3300
	B33-75x10-7643-WT	White	75.00	10.00	15.08	750	B30-R6000HF	i3300
	B33-75x10-7643-YL	Yellow	75.00	10.00	15.08	750	B30-R6000HF	i3300
	B33-75x15-7643-BK	Black	75.00	15.00	20.02	500	B30-R4400-WT	i3300
	B33-75x15-7643-BL	Blue	75.00	15.00	20.02	500	B30-R6000HF	i3300
	B33-75x15-7643-GN	Green	75.00	15.00	20.02	500	B30-R6000HF	i3300
	B33-75x15-7643-OR	Orange	75.00	15.00	20.02	500	B30-R6000HF	i3300
	B33-75x15-7643-RD	Red	75.00	15.00	20.02	500	B30-R6000HF	i3300
	B33-75x15-7643-WT	White	75.00	15.00	20.02	500	B30-R6000HF	i3300
	B33-75x15-7643-YL	Yellow	75.00	15.00	20.02	500	B30-R6000HF	i3300
	B33-75x25-7643-BK	Black	75.00	25.00	30.16	250	B30-R4400-WT	i3300
	B33-75x25-7643-BL	Blue	75.00	25.00	30.16	250	B30-R6000HF	i3300
	B33-75x25-7643-GN	Green	75.00	25.00	30.16	250	B30-R6000HF	i3300
	B33-75x25-7643-OR	Orange	75.00	25.00	30.16	250	B30-R6000HF	i3300
	B33-75x25-7643-RD	Red	75.00	25.00	30.16	250	B30-R6000HF	i3300
	B33-75x25-7643-WT	White	75.00	25.00	30.16	250	B30-R6000HF	i3300
	B33-75x25-7643-YL	Yellow	75.00	25.00	30.16	250	B30-R6000HF	i3300



B-348 Mass transit cable tag

Fully compliant mass transit tag



Diagram	Order Reference	Colour	Label Width A (mm)	Label Height B (mm)	Vertical Repeat D (mm)	Labels per Roll	Printer Ribbon Series	Printer Compatibility
B-348: Polyolefin								
	B33-6010-348-WT	White	60.00	10.00	15.08	750	B30-R6000HF	i3300
	B33-6010-348-YL	Yellow	60.00	10.00	15.08	750	B30-R6000HF	i3300
	B33-7510-348-WT	White	75.00	10.00	15.08	750	B30-R6000HF	i3300
	B33-7510-348-YL	Yellow	75.00	10.00	15.08	750	B30-R6000HF	i3300
	B33-7515-348-WT	White	75.00	15.00	20.02	500	B30-R6000HF	i3300
	B33-7515-348-YL	Yellow	75.00	15.00	20.02	500	B30-R6000HF	i3300
	B33-7525-348-WT	White	75.00	25.00	30.16	250	B30-R6000HF	i3300
	B33-7525-348-YL	Yellow	75.00	25.00	30.16	250	B30-R6000HF	i3300

How to select a wire marker

There are four main questions to ask yourself when you're starting the process of marking wires. These questions will help you select a wire marker that best suits your needs.

1. Are you marking the wire after termination?

Sleeve markers can only be used before termination because they must be slipped over the open end of the wire. These non-adhesive markers provide flexibility as they can be moved prior to being heat-shrunk. Once shrunk, these markers fit snugly around wires for permanent identification which will stand up to harsh environments.

2. What size of wire are you marking?

The diameter of the wire determines the size of the sleeve or the height of the label to be used.

3. Will you print your own markers or purchase preprinted ones?

Pre-printed markers are available in a large variety of stock legends, and custom legends are available for any large jobs. These markers come in a variety of packaging and formats for ease of use and ease of transport. They are ideal for any application.

Printable markers are meant to be printed with variable legends as needed. Various methods for this include: portable wire marking printers or computer software linked to thermal transfer, dot matrix or laser-printers. An extensive array of sizes are available for every application. These printable markers offer the flexibility of printing legends on demand. They are also ideal for applications that require long legends.

4. In what type of environment will these wire markers be placed?

It is extremely important to select a wire marker material that will last for your application. Too many companies go to the trouble of marking only to have to do it all again because they did not select the correct material. Be sure to ask yourself these questions before you select your wire marker.

How to select a marker size

Brady offers a variety of marker sizes for your wire marking needs. Please view the chart listed below to assist you in choosing the minimum recommended flattened sleeve height for the wire or cable that you are identifying.

Sleeve code	Flattened Sleeve Height (mm)	Max. Wire/Cable Diameter (mm)	Min. Wire/Cable Diameter (mm)
B-342 PermaSleeve™ PS Polyolefin Wire Marking Sleeves			
094	4.60	2.03	0.58
125	6.00	2.79	1.17
187	8.50	3.81	1.57
250	11.15	5.46	2.39
375	16.40	8.13	3.18
500	21.60	11.43	4.75
750	31.80	17.78	6.35
1000	42.16	24.13	9.53
1500	61.80	36.83	12.70
B-345 PermaSleeve™ High Temperature PVDF Wire Marking Sleeves			
094	4.60	2.00	0.60
125	6.00	2.80	1.20
187	8.50	3.80	1.60
250	11.15	5.50	2.40
375	16.40	8.10	3.20
500	21.60	11.40	4.80
750	31.80	17.80	6.60
1000	42.16	24.10	11.40
1500	61.80	36.80	12.70
B-7641 PermaSleeve™ LSZH Low Smoke Zero Halogen Wire Marking Sleeves			
094	4.60	2.03	1.19
125	6.00	2.79	1.57
187	8.50	3.83	2.39
250	11.15	5.46	3.17
375	16.40	8.13	4.77
500	21.60	11.43	6.35
750	31.40	17.78	9.52
1000	42.16	24.13	11.43
1500	61.80	35.56	19.05
2000	80.40	48.26	25.40
B-7642 PermaSleeve™ Polyolefin Wire Marking Sleeves			
094	4.60	2.03	1.19
125	6.00	2.79	1.57
187	8.50	3.83	2.39
250	11.15	5.46	3.17
375	16.40	8.13	4.77
500	21.60	11.43	6.35
750	31.40	17.78	9.52
1000	42.16	24.13	11.43
1500	61.80	35.56	19.05
2000	80.40	48.26	25.40

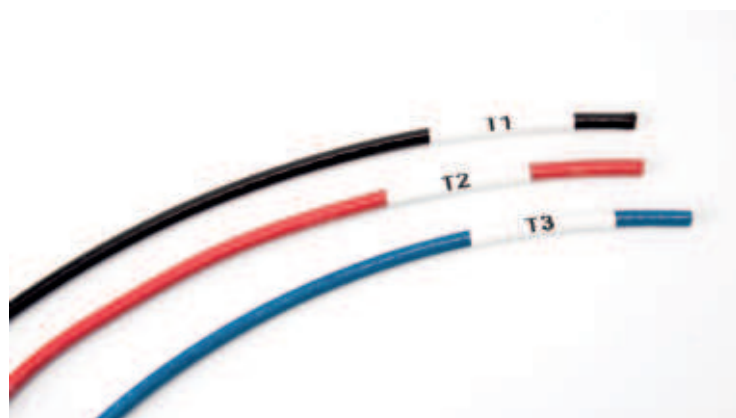



B-345 PermaSleeve HT high temperature PVDF wire marking sleeves

High temperature, low outgassing. 2:1 Shrink Ratio

- A 2:1 shrink ratio wire marker sleeve specifically designed for high temperature and low vacuum outgassing applications
- Made from irradiated high-temp Polyvinylidene Fluoride (PVDF) heat shrink tubing
- Fade-resistant and flame-retardant

Diagram	Order Reference	Colour	Label Width A (mm)	Label Height B (mm)	Vertical Repeat D (mm)	Labels per Roll	Printer Ribbon Series	Printer Compatibility
B-345: High Temperature Heat-shrink Polyvinylidene Fluoride Sleeve								
V	B33D-1000-2-345	White	50.80	42.16	–	250	B30-R6000HF	i3300
V	B33D-1000-2-345BK	Black	50.80	42.16	–	250	B30-R4500-SV	i3300
V	B33D-125-2-345	White	50.80	6.00	–	1000	B30-R6000HF	i3300
V	B33D-125-2-345BK	Black	50.80	6.00	–	1000	B30-R4500-SV	i3300
V	B33D-1500-2-345	White	50.80	61.80	–	150	B30-R6000HF	i3300
V	B33D-1500-2-345BK	Black	50.80	61.80	–	150	B30-R4500-SV	i3300
V	B33D-187-2-345	White	50.80	8.50	–	750	B30-R6000HF	i3300
V	B33D-187-2-345BK	Black	50.80	8.50	–	750	B30-R4500-SV	i3300
V	B33D-250-2-345	White	50.80	11.15	–	500	B30-R6000HF	i3300
V	B33D-250-2-345BK	Black	50.80	11.15	–	500	B30-R4500-SV	i3300
V	B33D-375-2-345	White	50.80	16.40	–	500	B30-R6000HF	i3300
V	B33D-375-2-345BK	Black	50.80	16.40	–	500	B30-R4500-SV	i3300
V	B33D-500-2-345	White	50.80	21.60	–	350	B30-R6000HF	i3300
V	B33D-500-2-345BK	Black	50.80	21.60	–	350	B30-R4500-SV	i3300
V	B33D-750-2-345	White	50.80	31.80	–	250	B30-R6000HF	i3300
V	B33D-750-2-345BK	Black	50.80	31.80	–	250	B30-R4500-SV	i3300
V	B33D-94-2-345*	White	50.80	4.60	–	1000	B30-R6000HF	i3300
V	B33D-94-2-345BK*	Black	50.80	4.60	–	1000	B30-R4500-SV	i3300

*This size is only 3:1 shrink ratio

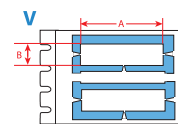

How to read your PermaSleeve order reference

Example order reference:

B33D - 187 - 2 - BK - 4
 Product Diameter Width Colour Pieces
 Optional

Order reference components PermaSleeve wire marking sleeves:

Product type B33 = Single-sided Printing B33D = Double-sided Printing	Sleeve width 2 = 50.80mm
Sleeve diameter 094 = 3/32" size fits wire diameter 0.58mm - 2.03mm 125 = 1/8" size fits wire diameter 1.17mm - 2.79mm 187 = 3/16" size fits wire diameter 1.57mm - 3.81mm 250 = 1/4" size fits wire diameter 2.39mm - 5.46mm 375 = 3/8" size fits wire diameter 3.18mm - 8.13mm 500 = 1/2" size fits wire diameter 4.75mm - 11.43mm 750 = 3/4" size fits wire diameter 6.35mm - 17.78mm 1000 = 1" size fits wire diameter 9.53mm - 24.13mm 1500 = 1 1/2" size fits wire diameter 12.7mm - 36.83mm	Sleeve Colour BK = Black WT = White YL = Yellow
Optional: Pieces Per Sleeve While 1 marker per sleeve is standard, the sleeve can be split into multiple pieces. Example: B33-1500-2-342-2 This "2" means that this 50.80mm sleeve is slit into two 25.40mm pieces	

B-342 PermaSleeve PS polyolefin wire marking sleeves

Standard military/industrial grade. 3:1 Shrink ratio

- A 3:1 heat shrinkable wire marker sleeve that fits snugly around wires
- Can be used for identification or wire protection
- Fade-resistant and flame-retardant

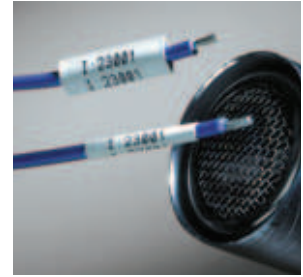
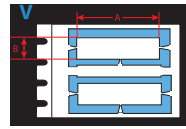
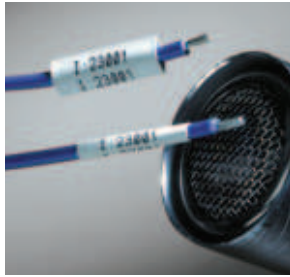

Diagram	Order Reference	Colour	Label Width A (mm)	Label Height B (mm)	Vertical Repeat D (mm)	Labels per Roll	Printer Ribbon Series	Printer Compatibility
B-342: Heat-shrink Polyolefin Sleeve								
V	B33-1000-2-342	White	50.80	42.16	–	250	B30-R4300	i3300
V	B33-1000-2-342-2	White	25.40	42.16	–	500	B30-R4300	i3300
V	B33-1000-2-342YL	Yellow	50.80	42.16	–	250	B30-R4300	i3300
V	B33-1000-2-342YL-2	Yellow	25.40	42.16	–	500	B30-R4300	i3300
V	B33-125-2-342	White	50.80	6.00	–	1000	B30-R4300	i3300
V	B33-125-2-342-2	White	25.40	6.00	–	2000	B30-R4300	i3300
V	B33-125-2-342YL	Yellow	50.80	6.00	–	1000	B30-R4300	i3300
V	B33-125-2-342YL-2	Yellow	25.40	6.00	–	2000	B30-R4300	i3300
V	B33-1500-2-342	White	50.80	61.80	–	150	B30-R4300	i3300
V	B33-1500-2-342-2	White	25.40	61.80	–	300	B30-R4300	i3300
V	B33-1500-2-342BK	Black	50.80	61.80	–	150	B30-R4500-SV	i3300
V	B33-1500-2-342YL	Yellow	50.80	61.80	–	150	B30-R4300	i3300
V	B33-1500-2-342YL-2	Yellow	25.40	61.80	–	300	B30-R4300	i3300
V	B33-187-2-342	White	50.80	8.50	–	750	B30-R4300	i3300
V	B33-187-2-342-2	White	25.40	8.50	–	1500	B30-R4300	i3300
V	B33-187-2-342YL	Yellow	50.80	8.50	–	750	B30-R4300	i3300
V	B33-250-2-342	White	50.80	11.15	–	500	B30-R4300	i3300
V	B33-250-2-342-2	White	25.40	11.15	–	1000	B30-R4300	i3300
V	B33-250-2-342YL	Yellow	50.80	11.15	–	500	B30-R4300	i3300
V	B33-375-2-342	White	50.80	16.40	–	500	B30-R4300	i3300
V	B33-375-2-342-2	White	25.40	16.40	–	1000	B30-R4300	i3300
V	B33-375-2-342YL	Yellow	50.80	16.40	–	500	B30-R4300	i3300
V	B33-500-2-342	White	50.80	21.60	–	350	B30-R4300	i3300
V	B33-500-2-342-2	White	25.40	21.60	–	700	B30-R4300	i3300
V	B33-500-2-342YL	Yellow	50.80	21.60	–	350	B30-R4300	i3300
V	B33-500-2-342YL-2	Yellow	25.40	21.60	–	700	B30-R4300	i3300
V	B33-750-2-342	White	50.80	31.80	–	250	B30-R4300	i3300
V	B33-750-2-342YL	Yellow	50.80	31.80	–	250	B30-R4300	i3300
V	B33-94-2-342	White	50.80	4.60	–	1000	B30-R4300	i3300
V	B33-94-2-342-2	White	25.40	4.60	–	2000	B30-R4300	i3300
V	B33-94-2-342YL	Yellow	50.80	4.60	–	1000	B30-R4300	i3300
V	B33-94-2-342YL-2	Yellow	25.40	4.60	–	2000	B30-R4300	i3300
V	B33D-1000-2-342	White	50.80	42.16	–	250	B30-R4300	i3300
V	B33D-1000-2-342BK	Black	50.80	42.16	–	250	B30-R4500-SV	i3300
V	B33D-1000-2-342YL	Yellow	50.80	42.16	–	250	B30-R4300	i3300
V	B33D-125-2-342	White	50.80	6.00	–	1000	B30-R4300	i3300
V	B33D-125-2-342BK	Black	50.80	6.00	–	1000	B30-R4500-SV	i3300
V	B33D-125-2-342YL	Yellow	50.80	6.00	–	1000	B30-R4300	i3300
V	B33D-1500-2-342	White	50.80	61.80	–	150	B30-R4300	i3300
V	B33D-1500-2-342BK	Black	50.80	61.80	–	150	B30-R4500-SV	i3300
V	B33D-1500-2-342YL	Yellow	50.80	61.80	–	150	B30-R4300	i3300
V	B33D-187-2-342	White	50.80	8.50	–	750	B30-R4300	i3300
V	B33D-187-2-342BK	Black	50.80	8.50	–	750	B30-R4500-SV	i3300
V	B33D-187-2-342YL	Yellow	50.80	8.50	–	750	B30-R4300	i3300
V	B33D-250-2-342	White	50.80	11.15	–	500	B30-R4300	i3300
V	B33D-250-2-342BK	Black	50.80	11.15	–	500	B30-R4500-SV	i3300
V	B33D-250-2-342YL	Yellow	50.80	11.15	–	500	B30-R4300	i3300
V	B33D-375-2-342	White	50.80	16.40	–	500	B30-R4300	i3300

>>



B-342 PermaSleeve PS polyolefin wire marking sleeves (Continued)

Standard military/industrial grade. 3:1 Shrink ratio

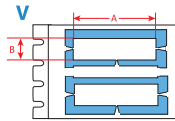

Diagram	Order Reference	Colour	Label Width A (mm)	Label Height B (mm)	Vertical Repeat D (mm)	Labels per Roll	Printer Ribbon Series	Printer Compatibility
V	B33D-375-2-342BK	Black	50.80	16.40	–	500	B30-R4500-SV	i3300
V	B33D-375-2-342YL	Yellow	50.80	16.40	–	500	B30-R4300	i3300
V	B33D-500-2-342	White	50.80	21.60	–	350	B30-R4300	i3300
V	B33D-500-2-342BK	Black	50.80	21.60	–	350	B30-R4500-SV	i3300
V	B33D-500-2-342YL	Yellow	50.80	21.60	–	350	B30-R4300	i3300
V	B33D-750-2-342	White	50.80	31.80	–	250	B30-R4300	i3300
V	B33D-750-2-342BK	Black	50.80	31.80	–	250	B30-R4500-SV	i3300
V	B33D-750-2-342YL	Yellow	50.80	31.80	–	250	B30-R4300	i3300
V	B33D-94-2-342	White	50.80	4.60	–	1000	B30-R4300	i3300
V	B33D-94-2-342BK	Black	50.80	4.60	–	1000	B30-R4500-SV	i3300
V	B33D-94-2-342YL	Yellow	50.80	4.60	–	1000	B30-R4300	i3300



B-7641 PermaSleeve low smoke zero halogen wire marking sleeves

Permanent heat shrink wire identification

- A 2:1 double-sided printable heat-shrink Polyolefin wire marker sleeve designed for wire identification and insulation purposes
- Contains no added halogens, offers excellent flame retardant characteristics combined with minimal smoke emission

Diagram	Order Reference	Colour	Label Width A (mm)	Label Height B (mm)	Vertical Repeat D (mm)	Labels per Roll	Printer Ribbon Series	Printer Compatibility
B-7641: Heat-shrink Polyolefin Sleeve								
V	B33D-1000-2-7641	White	50.80	40.64	–	250	B30-R6600	i3300
V	B33D-1000-2-7641Y	Yellow	50.80	40.64	–	250	B30-R6600	i3300
V	B33D-125-2-7641	White	50.80	5.49	–	1000	B30-R6600	i3300
V	B33D-125-2-7641Y	Yellow	50.80	5.49	–	1000	B30-R6600	i3300
V	B33D-1500-2-7641	White	50.80	61.80	–	150	B30-R6600	i3300
V	B33D-1500-2-7641Y	Yellow	50.80	61.80	–	150	B30-R6600	i3300
V	B33D-187-2-7641	White	50.80	7.95	–	750	B30-R6600	i3300
V	B33D-187-2-7641Y	Yellow	50.80	7.95	–	750	B30-R6600	i3300
V	B33D-250-2-7641	White	50.80	10.54	–	500	B30-R6600	i3300
V	B33D-250-2-7641Y	Yellow	50.80	10.54	–	500	B30-R6600	i3300
V	B33D-375-2-7641	White	50.80	15.42	–	500	B30-R6600	i3300
V	B33D-375-2-7641Y	Yellow	50.80	15.42	–	500	B30-R6600	i3300
V	B33D-500-2-7641	White	50.80	20.32	–	350	B30-R6600	i3300
V	B33D-500-2-7641Y	Yellow	50.80	20.32	–	350	B30-R6600	i3300
V	B33D-750-2-7641	White	50.80	30.51	–	250	B30-R6600	i3300
V	B33D-750-2-7641Y	Yellow	50.80	30.51	–	250	B30-R6600	i3300
V	B33D-94-2-7641	White	50.80	4.29	–	1000	B30-R6600	i3300
V	B33D-94-2-7641Y	Yellow	50.80	4.29	–	1000	B30-R6600	i3300

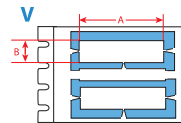

B-7642 PermaSleeve HX polyolefin wire marking sleeves

Military/Industrial grade. 2:1 Shrink ratio

- A 2:1 heat shrinkable wire marker sleeve that fits snugly around wires
- Flame-retardant and high-temp rated but not as high temp as B-345 “HT” Sleeves

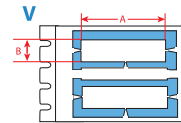
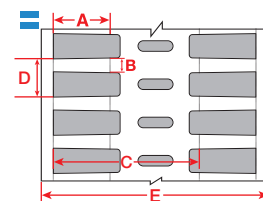

Diagram	Order Reference	Colour	Label Width A (mm)	Label Height B (mm)	Vertical Repeat D (mm)	Labels per Roll	Printer Ribbon Series	Printer Compatibility
B-7642: Heat-shrink Polyolefin Sleeve								
V	B33-1000-2-7642	White	50.80	42.16	–	150	B30-R4300	i3300
V	B33-125-2-7642	White	50.80	6.00	–	500	B30-R4300	i3300
V	B33-1500-2-7642	White	50.80	61.80	–	50	B30-R4300	i3300
V	B33-187-2-7642	White	50.80	8.50	–	450	B30-R4300	i3300
V	B33-2000-2-7642	White	50.80	80.40	–	50	B30-R4300	i3300
V	B33-250-2-7642	White	50.80	11.15	–	400	B30-R4300	i3300
V	B33-375-2-7642	White	50.80	16.40	–	250	B30-R4300	i3300
V	B33-500-2-7642	White	50.80	21.60	–	225	B30-R4300	i3300
V	B33-750-2-7642	White	50.80	31.40	–	150	B30-R4300	i3300
V	B33-94-2-7642	White	50.80	4.60	–	500	B30-R4300	i3300
V	B33D-1000-2-7642	White	50.80	42.16	–	150	B30-R4300	i3300
V	B33D-125-2-7642	White	50.80	6.00	–	500	B30-R4300	i3300
V	B33D-1500-2-7642	White	50.80	61.80	–	50	B30-R4300	i3300
V	B33D-187-2-7642	White	50.80	8.50	–	450	B30-R4300	i3300
V	B33D-2000-2-7642	White	50.80	80.40	–	50	B30-R4300	i3300
V	B33D-250-2-7642	White	50.80	11.15	–	400	B30-R4300	i3300
V	B33D-375-2-7642	White	50.80	16.40	–	250	B30-R4300	i3300
V	B33D-500-2-7642	White	50.80	21.60	–	225	B30-R4300	i3300
V	B33D-750-2-7642	White	50.80	31.40	–	150	B30-R4300	i3300
V	B33D-94-2-7642	White	50.80	4.60	–	500	B30-R4300	i3300

B-7697 Rigid DuraSleeve wire marking inserts

Diagram	Order Reference	Colour	Label Width A (mm)	Label Height B (mm)	Vertical Repeat D (mm)	Labels per Roll	Printer Ribbon Series	Printer Compatibility
B-7697: Polyester Tag								
≡	B33-10x4,4-7697-WT	White	10.00	4.40	11.46	2500	R4300; R6200	i3300
≡	B33-12x4,4-7697-WT	White	12.00	4.40	11.46	2500	R4300; R6200	i3300
≡	B33-16x4,4-7697-WT	White	16.00	4.40	11.46	2500	R4300; R6200	i3300
≡	B33-23x4,4-7697-WT	White	23.00	4.40	11.46	2500	R4300; R6200	i3300
≡	B33-30x4,4-7697-WT	White	30.00	4.40	11.46	2500	R4300; R6200	i3300



Durasleeve tag carrier

DuraSleeve tag carriers are produced in transparent PVC. The special shape of the carrier allows it to adapt to cables of various diameters. There are several sizes of carriers which cater for cables with external diameters from 1.30 mm up to 15 mm.

- Temperature range: -40 °C to 60 °C
- Material: PVC

Please contact your local Brady representative to identify and select the most appropriate carrier for your individual application.



Product & general purpose identification



Polyester labels

For general purpose industrial identification applications

- Widely used for PC board component identification, bin and shelf labels, barcoding and asset tracking
- 3 levels of adhesive strength

Diagram	Order Reference	Colour	Label Width A (mm)	Label Height B (mm)	Label Length B (m)	Vertical Repeat D (mm)	Labels per Roll	Printer Ribbon Series	Printer Compatibility
B-422: Polyester									
▲	B33-102-422	White	9.39	38.10	-	12.70	2500	B30-R6000HF	i3300
●	B33-147-422	White	9.53	38.10	-	12.10	2500	B30-R6000HF	i3300
●	B33-149-422	White	12.70	12.70	-	15.20	5000	B30-R6000HF	i3300
▲	B33-17-422	White	25.40	50.80	-	28.60	1500	B30-R6000HF	i3300
▲	B33-18-422	White	25.40	76.20	-	28.60	1500	B30-R6000HF	i3300
●	B33-5-422	White	25.40	12.70	-	15.20	5000	B30-R6000HF	i3300
▲	B33-136-422	White	38.10	19.05	-	22.23	1500	B30-R6000HF	i3300
▲	B33-19-422	White	50.80	76.20	-	54.00	500	B30-R6000HF	i3300
▲	B33-76-422	White	76.20	101.60	-	79.40	500	B30-R6000HF	i3300
◎	B33C-312-422	White	7.92	-	25.91	-	1	B30-R6000HF	i3300
◎	B33C-375-422	White	9.53	-	25.91	-	1	B30-R6000HF	i3300
B-423: Polyester									
▲	B33-103-423	White	6.35	25.40	-	8.90	5000	B30-R6000HF	i3300
●	B33-11-423	White	6.35	6.35	-	9.50	15000	B30-R6000HF	i3300
●	B33-1-423	White	6.35	19.05	-	8.90	5000	B30-R6000HF	i3300
▲	B33-43-423	White	6.35	31.75	-	8.90	5000	B30-R6000HF	i3300
▲	B33-45-423	White	6.35	38.10	-	8.90	5000	B30-R6000HF	i3300
▲	B33-46-423	White	6.35	19.05	-	8.90	5000	B30-R6000HF	i3300
▲	B33-49-423	White	6.35	22.86	-	8.90	5000	B30-R6000HF	i3300
▲	B33-72-423	White	6.35	44.45	-	8.90	5000	B30-R6000HF	i3300
●	B33-29-423	White	9.53	31.75	-	12.10	5000	B30-R6000HF	i3300
●	B33-3-423	White	9.53	25.40	-	12.10	5000	B30-R6000HF	i3300
●	B33-38-423	White	9.53	9.53	-	12.10	5000	B30-R6000HF	i3300
●	B33-149-423	White	12.70	12.70	-	15.20	5000	B30-R6000HF	i3300
●	B33-5-423	White	25.40	12.70	-	15.24	5000	B30-R6000HF	i3300
▲	B33-19-423	White	50.80	76.20	-	54.00	500	B30-R6000HF	i3300
▲	B33-53-423	White	50.80	12.70	-	15.24	2500	B30-R6000HF	i3300
▲	B33-55-423	White	50.80	101.60	-	54.00	750	B30-R6000HF	i3300
▲	B33-17-423	White	50.80	25.40	-	28.60	1500	B30-R6000HF	i3300
▲	B33-18-423	White	76.20	25.40	-	28.60	1500	B30-R6000HF	i3300
◎	B30C-4000-423	White	101.00	-	45.70	-	1	B30-R-6000	BBP35, BBP37, i3300, S3000, S3100
B-430: Polyester									
●	B33-5-430	Clear	25.40	12.70	-	15.90	5000	B30-R6000HF	i3300
▲	B33-17-430	Clear	50.80	25.40	-	28.60	1500	B30-R6000HF	i3300
▲	B33-18-430	Clear	76.20	25.40	-	28.60	1500	B30-R6000HF	i3300
B-432: Polyester									
●	B33-149-432	Clear	12.70	12.70	-	15.90	5000	B30-R6000HF	i3300
▲	B33-17-432	Clear	50.80	25.40	-	28.60	5000	B30-R6000HF	i3300
▲	B33-18-432	Clear	76.20	25.40	-	28.60	1500	B30-R6000HF	i3300
▲	B33-19-432	Clear	76.20	50.80	-	54.00	500	B30-R6000HF	i3300
◎	B30C-4000-432	Clear	101.00	-	36.60	-	1	B30-R-6000	BBP35, BBP37, i3300, S3000, S3100
B-483: Polyester									
●	B33-149-483	White	12.70	12.70	-	15.20	5000	B30-R6000HF	i3300
●	B33-5-483	White	25.40	12.70	-	15.24	5000	B30-R6000HF	i3300
▲	B33-7-483	White	31.75	69.85	-	34.90	1000	B30-R6000HF	i3300
▲	B33-55-483	White	50.80	101.60	-	54.00	750	B30-R6000HF	i3300
▲	B33-17-483	White	50.80	25.40	-	28.60	1500	B30-R6000HF	i3300
▲	B33-19-483	White	76.20	50.80	-	54.00	500	B30-R6000HF	i3300
▲	B33-18-483	White	76.20	25.40	-	28.60	1500	B30-R6000HF	i3300
◎	B30C-4000-483	White	101.00	-	39.60	-	1	B30-R-6000	BBP35, BBP37, i3300, S3000, S3100

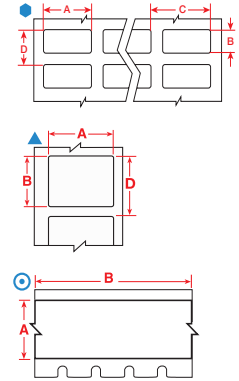

>>

Polyester labels (Continued)

For general purpose industrial identification applications



Diagram	Order Reference	Colour	Label Width A (mm)	Label Height B (mm)	Label Length B (m)	Vertical Repeat D (mm)	Labels per Roll	Printer Ribbon Series	Printer Compatibility
B-484A: Polyester									
▲	B33-125-484	White	22.86	12.70	-	15.20	1500	B30-R6000HF	i3300
▲	B33-17-484	White	25.40	50.80	-	28.60	1500	B30-R6000HF	i3300
▲	B33-18-484	White	25.40	76.20	-	28.60	1500	B30-R6000HF	i3300
●	B33-5-484	White	25.40	12.70	-	15.20	5000	B30-R6000HF	i3300
▲	B33-136-484	White	38.10	19.05	-	22.23	1500	B30-R6000HF	i3300
▲	B33-19-484	White	50.80	76.20	-	54.00	500	B30-R6000HF	i3300
◎	B30C-4000-484	White	101.00	-	45.70	-	1	B30-R-6000	BBP35, BBP37, i3300, S3000, S3100
B-488: Polyester									
◎	B30C-4000-488	White	101.00	-	39.60	-	1	B30-R-4300	BBP35, BBP37, i3300, S3000, S3100
B-489: Polyester									
●	B33-5-489	White	25.40	12.70	-	15.24	5000	B30-R4300	i3300
▲	B33-17-489	White	50.80	25.40	-	28.60	1500	B30-R4300	i3300
▲	B33-19-489	White	76.20	50.80	-	54.00	500	B30-R4300	i3300
▲	B33-18-489	White	76.20	25.40	-	28.60	1500	B30-R4300	i3300
◎	B30C-4000-489	White	101.00	-	39.60	-	1	B30-R-4300	BBP35, BBP37, i3300, S3000, S3100
B-8423: Polyester									
●	B33-12-8423	White	12.70	11.10	-	14.13	2500	B30-R6000HF	i3300
●	B33-101-8423	White	19.05	6.35	-	9.40	2500	B30-R6000HF	i3300
●	B33-G2-8423YL	Yellow	20.00	8.00	-	15.00	5000	B30-R6000HF	i3300
●	B33-13-8423	White	31.75	6.35	-	9.35	2500	B30-R6000HF	i3300
●	B33-104-8423	White	38.10	6.35	-	9.33	2500	B30-R6000HF	i3300
●	B33-6-8423	White	38.10	19.05	-	22.05	2500	B30-R6000HF	i3300

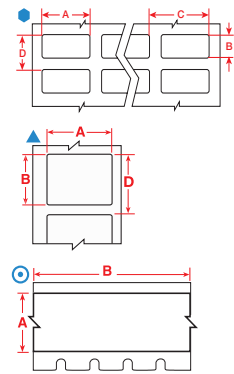

Metallised polyester labels

For product labelling, asset tracking and general industrial identification

- Silver metallic label withstands solvents and variable temperatures
- Ideal for serial number plates and rating plates with nameplate quality and metal looking finish



Diagram	Order Reference	Colour	Label Width A (mm)	Label Height B (mm)	Label Length B (m)	Vertical Repeat D (mm)	Labels per Roll	Printer Ribbon Series	Printer Compatibility
B-428: Metallised Polyester									
●	B33-616-428	Silver	22.86	19.05	-	22.05	3000	B30-R4300	i3300
●	B33-5-428	Silver	25.40	12.70	-	15.24	5000	B30-R4300	i3300
▲	B33-19-428	Silver	50.80	76.20	-	54.00	500	B30-R4300	i3300
▲	B33-53-428	Silver	50.80	12.70	-	15.24	2500	B30-R4300	i3300
▲	B33-17-428	Silver	50.80	25.40	-	28.60	1500	B30-R4300	i3300
▲	B33-18-428	Silver	76.20	25.40	-	28.60	1500	B30-R4300	i3300
◎	B30C-4000-428	Silver	101.00	-	39.60	-	1	B30-R-4300	BBP35, BBP37, i3300, S3000, S3100
B-434: Metallised Polyester									
●	B33-5-434	Silver	25.40	12.70	-	15.24	5000	B30-R6000HF	i3300
▲	B33-136-434	Silver	38.10	19.05	-	22.23	1500	B30-R6000HF	i3300
▲	B33-55-434	Silver	50.80	101.60	-	54.00	750	B30-R6000HF	i3300
▲	B33-17-434	Silver	50.80	25.40	-	28.60	1500	B30-R6000HF	i3300
▲	B33-18-434	Silver	76.20	25.40	-	28.60	1500	B30-R6000HF	i3300
▲	B33-19-434	Silver	76.20	50.80	-	54.00	500	B30-R6000HF	i3300
◎	B30C-4000-434	Silver	101.00	-	39.60	-	1	B30-R-6000	BBP35, BBP37, i3300, S3000, S3100
B-435: Metallised Polyester									
▲	B33-18-435	Silver	25.40	76.20	-	28.60	1500	B30-R6000HF	i3300
▲	B33-19-435	Silver	50.80	76.20	-	54.00	500	B30-R6000HF	i3300

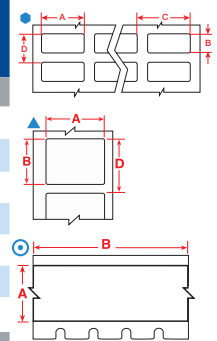

Product & general purpose identification



Metallised polyester labels (Continued)

For product labelling, asset tracking and general industrial identification

Diagram	Order Reference	Colour	Label Width A (mm)	Label Height B (mm)	Label Length B (m)	Vertical Repeat D (mm)	Labels per Roll	Printer Ribbon Series	Printer Compatibility
▲	B33-55-435	Silver	101.60	50.80	-	54.00	750	B30-R6000HF	i3300
B-438: Tamper-evident Metallised Polyester									
▲	B30-17-438	Silver	25.40	50.80	-	28.60	1225	B30-R4300	BBP35, BBP37, i3300, S3000, S3100
▲	B30-222-438	Silver	76.20	50.80	-	57.15	650	B30-R4300	BBP35, BBP37, i3300, S3000, S3100
∞	B30C-3000-438	Silver	75.00	-	30.40	-	1	B30-R4300	BBP35, BBP37, i3300, S3000, S3100
▲	B30-18-438	Silver	76.20	25.40	39.00	31.75	1225	B30-R4300	BBP35, BBP37, i3300, S3000, S3100
B-480A: Metallic, Non-metal Polyester									
⊙	B30C-4000-480	Light Grey	101.00	-	34.50	-	1	B30-R6000	BBP35, BBP37, i3300, S3000, S3100
B-486B: Metallised Polyester									
▲	B33-59-486	Light Grey	25.40	12.70	-	34.90	2500	B30-R4300	i3300
▲	B33-53-486	Light Grey	50.80	12.70	-	15.24	2500	B30-R4300	i3300
▲	B33-17-486	Light Grey	50.80	25.40	-	28.60	1300	B30-R4300	i3300
▲	B33-7-486	Light Grey	69.85	31.75	-	79.40	1000	B30-R4300	i3300
▲	B33-19-486	Light Grey	76.20	50.80	-	54.00	500	B30-R4300	i3300
▲	B33-18-486	Light Grey	76.20	25.40	-	28.60	1300	B30-R4300	i3300
▲	B33-161-486	Light Grey	101.60	101.60	-	15.20	250	B30-R4300	i3300
⊙	B30C-4000-486	Light Grey	101.00	-	35.10	-	1	B30-R-4300	BBP35, BBP37, i3300, S3000, S3100
B-565: Metallised Polyester									
∞	B30C-1125-565-SL	Silver	29.00	-	30.40	-	1	B30-R10000	BBP35, BBP37, i3300, S3000, S3100
∞	B30C-2250-565-SL	Silver	57.00	-	30.40	-	1	B30-R10000	BBP35, BBP37, i3300, S3000, S3100
∞	B30C-4000-565-SL	Silver	101.00	-	30.40	-	1	B30-R10000	BBP35, BBP37, i3300, S3000, S3100
B-7563: Metallised Polyester									
◆	B33-600-7563	Silver	38.10	19.05	-	22.05	2500	B30-R6000HF	i3300
◆	B30-135-7563	Silver	38.10	19.05	-	22.22	3154	B30-R6000HF	BBP35, BBP37, i3300, S3000, S3100
▲	B30-17-7563	Silver	50.80	25.40	-	28.57	1226	B30-R6000HF	BBP35, BBP37, i3300, S3000, S3100
▲	B30-7-7563	Silver	69.85	31.75	-	34.92	1003	B30-R6000HF	BBP35, BBP37, i3300, S3000, S3100
▲	B30-222-7563	Silver	76.20	50.80	-	57.15	649	B30-R6000HF	BBP35, BBP37, i3300, S3000, S3100

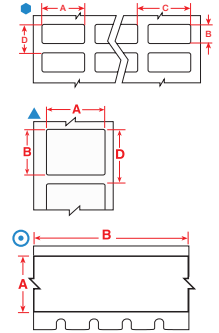

B-424 Paper labels

Economical choice for light duty general identification

- White finish and matt topcoat
- Excellent contrast and smear resistance for barcode printing



Diagram	Order Reference	Colour	Label Width A (mm)	Label Height B (mm)	Label Length B (m)	Vertical Repeat D (mm)	Labels per Roll	Printer Ribbon Series	Printer Compatibility
B-424: Paper									
▲	B33-7-424	White	31.75	69.85	-	34.90	1000	B30-R4300	i3300
▲	B33-53-424	White	50.80	12.70	-	15.24	2500	B30-R4300	i3300
▲	B33-55-424	White	50.80	101.60	-	54.00	750	B30-R4300	i3300
▲	B33-17-424	White	50.80	25.40	-	28.60	1500	B30-R4300	i3300
▲	B33-20-424	White	76.20	127.00	-	130.20	250	B30-R4300	i3300
▲	B33-19-424	White	76.20	50.80	-	54.00	500	B30-R4300	i3300
▲	B33-18-424	White	76.20	25.40	-	28.60	1500	B30-R4300	i3300
▲	B33-25-424	White	152.40	101.60	-	155.60	350	B30-R4300	i3300
⊙	B30C-4000-424	White	101.00	-	45.70	-	1	B30-R-4300	BBP35, BBP37, i3300, S3000, S3100

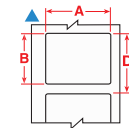

B-425 Polypropylene labels

General labelling material for indoor use

- Outstanding chemical and solvent resistance and print performance
- Not recommended for prolonged outdoor use (use B-595 indoor/outdoor vinyl for 8-10 year outdoor use)



Diagram	Order Reference	Colour	Label Width A (mm)	Label Height B (mm)	Label Length B (m)	Vertical Repeat D (mm)	Labels per Roll	Printer Ribbon Series	Printer Compatibility
B-425A: Polypropylene									
●	B33-5-425	White	25.40	12.70	-	15.24	5000	B30-R4300	i3300
▲	B33-17-425	White	50.80	25.40	-	28.60	1500	B30-R4300	i3300
▲	B33-18-425	White	76.20	25.40	-	28.60	1500	B30-R4300	i3300
▲	B33-19-425	White	76.20	50.80	-	54.00	500	B30-R4300	i3300

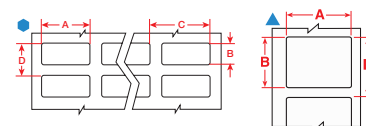

B-595 Outdoor grade vinyl labels

For 8-10 year outdoor use

- Semi-gloss finish
- Good chemical, moisture, UV and weather resistance
- Highly pliable material conforms to rough and curved surfaces and equipment
- Average outdoor durability of the label is 8-10 years depending on the placement



Diagram	Order Reference	Colour	Label Width A (mm)	Label Height B (mm)	Label Length B (m)	Vertical Repeat D (mm)	Labels per Roll	Printer Ribbon Series	Printer Compatibility
B-595: Vinyl									
▲	B30-242-595-BLNKWT	White	29.00	72.00	-	82.60	300	B30-R10000	BBP35, BBP37, i3300, S3000, S3100
▲	B30-241-595-BLNKWT	White	57.00	75.00	-	82.60	300	B30-R10000	BBP35, BBP37, i3300, S3000, S3100
▲	B30-219-595-BLNKWT	White	57.00	98.00	-	108.00	250	B30-R10000	BBP35, BBP37, i3300, S3000, S3100
▲	B30-241-595-BLNKYL	Yellow	57.00	75.00	-	82.60	300	B30-R10000	BBP35, BBP37, i3300, S3000, S3100
▲	B30-25-595-BLNKWT	White	101.00	152.00	-	158.80	175	B30-R10000	BBP35, BBP37, i3300, S3000, S3100
▲	B30-25-595-BLNKYL	Yellow	101.00	152.00	-	158.80	175	B30-R10000	BBP35, BBP37, i3300, S3000, S3100

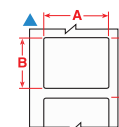

Average expected outdoor life of product will depend on user definition of failure, climatic conditions, mounting techniques and material colour. The up to 8 to 10 year outdoor durability applies to the vinyl label stock only; ribbon durability will vary. A polyester overlamine is recommended for harsh environments - long term exposure to wind and rain.

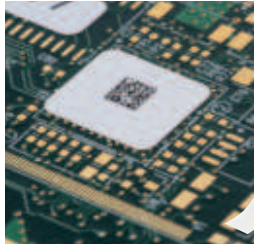

B-8423 Polyester labels

For circuit board and component identification

- SMT - Top/Bottom; Through Hole - Bottom; Through Hole - Top

Diagram	Order Reference	Colour	Label Width A (mm)	Label Height B (mm)	Label Length B (m)	Vertical Repeat D (mm)	Labels per Roll	Printer Ribbon Series	Printer Compatibility
B-8423: Polyester									
●	B33-12-8423	White	12.70	11.10	-	14.13	2500	B30-R6000HF	i3300
●	B33-101-8423	White	19.05	6.35	-	9.40	2500	B30-R6000HF	i3300
●	B33-G2-8423YL	Yellow	20.00	8.00	-	15.00	5000	B30-R6000HF	i3300
●	B33-13-8423	White	31.75	6.35	-	9.35	2500	B30-R6000HF	i3300
●	B33-104-8423	White	38.10	6.35	-	9.33	2500	B30-R6000HF	i3300

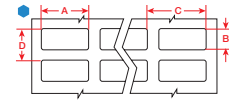

B-717, B-718 and B-719 Static dissipative polyimide labels

For printed circuit board and electronic component identification

- Static dissipative adhesive and release liner with surface resistivity values
- Complies with EIA-541 Packaging Material Standards for ESD sensitive items
- Withstands the various processes, fluxes and cleaning solvents encountered in the manufacture of PC Boards
- For use on top or bottom-sided component identification or board identification

Diagram	Order Reference	Colour	Label Width A (mm)	Label Height B (mm)	Label Length B (m)	Vertical Repeat D (mm)	Labels per Roll	Printer Ribbon Series	Printer Compatibility
B-717: Polyimide									
▲	B33-46-717	White	19.05	6.35	-	-	5000	B30-R6000HF	i3300
▲	B33-103-717	White	25.40	6.35	-	-	5000	B30-R6000HF	i3300
▲	B33-43-717	White	31.75	6.35	-	7.62	5000	B30-R6000HF	i3300
▲	B33-45-717	White	38.10	6.35	-	-	5000	B30-R6000HF	i3300
B-718: Polyimide									
●	B33-11-718	White	6.35	6.35	-	9.50	15000	B30-R6000HF	i3300
●	B33-38-718	White	9.53	9.53	-	12.53	5000	B30-R6000HF	i3300
●	B33-149-718	White	12.70	12.70	-	15.20	5000	B30-R6000HF	i3300
●	B33-1-718	White	19.05	6.35	-	8.90	5000	B30-R6000HF	i3300
▲	B33-46-718	White	19.05	6.35	-	-	5000	B30-R6000HF	i3300
▲	B33-49-718	White	22.86	6.35	-	-	5000	B30-R6000HF	i3300
▲	B33-45-718	White	38.10	6.35	-	-	5000	B30-R6000HF	i3300
▲	B33-72-718	White	44.45	6.35	-	-	5000	B30-R6000HF	i3300
B-719: Polyimide									
●	B33-38-719	White	9.53	9.53	-	12.53	5000	B30-R6000HF	i3300
▲	B33-46-719	White	19.05	6.35	-	-	5000	B30-R6000HF	i3300
●	B33-2-719	White	22.86	6.35	-	8.90	5000	B30-R6000HF	i3300
▲	B33-43-719	White	31.75	6.35	-	8.89	5000	B30-R6000HF	i3300

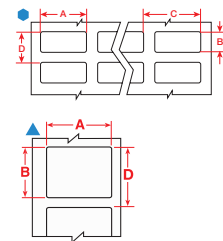

B-724 and B-727 Standard polyimide labels

For circuit board labels and high-temperature general identification applications

- Withstands the various processes, fluxes and cleaning solvents encountered in the manufacture of printed circuit boards
- For use on top bottom-side component identification or board identification
- 2 temperature levels to meet your needs

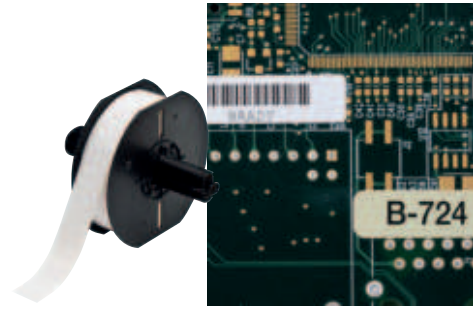
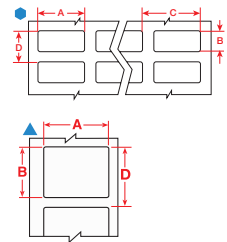

Diagram	Order Reference	Colour	Label Width A (mm)	Label Height B (mm)	Label Length B (m)	Vertical Repeat D (mm)	Labels per Roll	Printer Ribbon Series	Printer Compatibility
B-724: Polyimide									
●	B33-149-724	Amber	12.70	12.70	-	15.20	5000	B30-R4300	i3300
●	B33-1-724	Amber	19.05	6.35	-	8.90	5000	B30-R4300	i3300
▲	B33-46-724	Amber	19.05	6.35	-	-	5000	B30-R4300	i3300
●	B33-2-724	Amber	22.86	6.35	-	8.90	5000	B30-R4300	i3300
▲	B33-43-724	Amber	31.75	6.35	-	-	5000	B30-R4300	i3300
●	B33-4-724	Amber	38.10	6.35	-	8.90	5000	B30-R4300	i3300
◎	B30C-4000-724	Amber	101.00	-	39.60	-	1	B30-R-4300	BBP35, BBP37, i3300, S3000, S3100
B-727: Polyimide									
●	B33-11-727	White	6.35	6.35	-	9.50	5000	B30-R6000HF	i3300
●	B33-38-727	White	9.53	9.53	-	12.53	5000	B30-R6000HF	i3300
●	B33-149-727	White	12.70	12.70	-	15.20	5000	B30-R6000HF	i3300
●	B33-1-727	White	19.05	6.35	-	8.90	5000	B30-R6000HF	i3300
●	B33-2-727	White	22.86	6.35	-	8.90	5000	B30-R6000HF	i3300
▲	B33-49-727	White	22.86	6.35	-	8.90	5000	B30-R6000HF	i3300
▲	B33-103-727	White	25.40	6.35	-	8.90	5000	B30-R6000HF	i3300
▲	B33-58-727	White	25.40	9.53	-	12.10	4000	B30-R6000HF	i3300
▲	B33-59-727	White	25.40	12.70	-	15.20	2500	B30-R6000HF	i3300
▲	B33-43-727	White	31.75	6.35	-	8.90	5000	B30-R6000HF	i3300
▲	B33-44-727	White	34.93	6.35	-	8.90	5000	B30-R6000HF	i3300
▲	B33-45-727	White	38.10	6.35	-	8.90	5000	B30-R6000HF	i3300
▲	B33-72-727	White	44.45	6.35	-	-	5000	B30-R6000HF	i3300
◎	B30C-4000-727	White	101.00	-	39.60	-	1	B30-R-6000	BBP35, BBP37, i3300, S3000, S3100





B-461, B-490, B-492, B-498 & B-499 Vial & tube labels

Always have clear, legible specimen samples

- Labels are designed to withstand extreme laboratory environments.
- Resistant to laboratory solvents like Xylene, ethanol, alcohol and DMSO.
- Identification is always legible – and will not smear, fade or fall off.
- B-490, can be applied to frozen surfaces including glass and polypropylene stored in liquid nitrogen. Material must slightly overlap itself.
- B-492, can be applied to frozen surfaces including glass and polypropylene stored in liquid nitrogen.

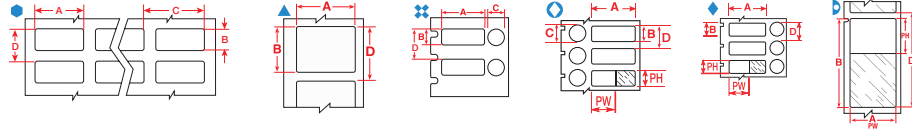

Diagram	Material	Special Properties	Label Width A (mm)	Label Height B (mm)	Label Length B (m)	Printable Area Width (mm)	Printable Area Height PH (mm)	Order Reference	Printer Compatibility	Printer Ribbon Series	Labels per Roll
0.5 - 0.7 ml											
●	B-499	F N A	12.70	19.05	-	-	-	B33-68-499	i3300	B30-R6000HF	1500
●	B-498	F R	12.70	19.05	-	-	-	B33-68-498	i3300	B30-R6200	5000
●	B-490	F N H L	12.70	19.05	-	-	-	B33-68-490	i3300	B30-R4300	2500
▲	B-499	F N A	12.70	25.40	-	-	-	B33-620-499	i3300	B30-R6000HF	1000
▷	B-461	F N A H S L	12.70	55.88	-	12.70	19.05	B33-127-461	i3300	B30-R4300	1500
●	B-499	F N A	25.40	9.53	-	-	-	B33-152-499	i3300	B30-R6000HF	1500
●	B-492	F N H L	25.40	9.53	-	-	-	B33-152-492	i3300	B30-R6400	2500
◆	B-461	F A H S L	25.40	9.53	-	20.00	9.53	B33-606-461	i3300	B30-R4300	1000
0.6 ml											
▲	B-499	F N A	22.86	12.70	-	-	-	B33-125-499	i3300	B30-R6000HF	1500
▲	B-490	F N H L	22.86	12.70	-	-	-	B33-125-490	i3300	B30-R4300	1650
1.0 - 2.0 ml											
▷	B-461	F N A H S L	15.24	38.10	-	15.24	33.03	B33-628-461	i3300	B30-R4300	2500
▷	B-461	F N A H S L	15.24	66.68	-	15.24	25.40	B33-612-461	i3300	B30-R4300	1500
⊘	B-499	F A	25.40	9.53	-	-	-	B33-163-499	i3300	B30-R6000HF	1500
⊘	B-492	F H L	25.40	9.53	-	-	-	B33-163-492	i3300	B30-R6400	1500
⊘	B-492	F H L	25.40	12.70	-	-	-	B33-182-492	i3300	B30-R6400	1500
⊘	B-492	F H L	25.40	12.70	-	-	-	B33-181-492	i3300	B30-R6400	1500
▷	B-461	F N A H S L	25.40	44.45	-	25.40	25.40	B33-183-461	i3300	B30-R4300	2000
◊	B-461	F A H S L	41.28	15.24	-	30.00	15.24	B33-608-461	i3300	B30-R4300	1000
1.0 - 8.0 ml											
▷	B-461	F N A H S L	15.24	66.68	-	15.24	25.40	B33-153-461	i3300	B30-R4300	1500
●	B-498	F R	19.05	23.80	-	-	-	B33-91-498	i3300	B30-R6200	2500
⊘	B-499	F A	22.86	12.70	-	-	-	B33-126-499	i3300	B30-R6000HF	1500
⊘	B-490	F H L	22.86	12.70	-	-	-	B33-126-490	i3300	B30-R4300	2500
●	B-498	F R	25.40	19.05	-	-	-	B33-88-498	i3300	B30-R6200	2500
⊘	B-492	F H L	41.28	15.24	-	-	-	B33-190-492	i3300	R6400	1500
▲	B-492	F N H L	41.28	15.24	-	-	-	B33-155-492	i3300	R6400	1500
▲	B-490	F N H L	41.28	15.24	-	-	-	B33-155-490	i3300	B30-R4300	1500
▲	B-492	F N H L	48.26	25.40	-	-	-	B33-156-492	i3300	B30-R6400	1500
▲	B-490	F N H L	48.26	25.40	-	-	-	B33-156-490	i3300	B30-R4300	1500
1.5 - 2.0 ml											
▷	B-461	F N A H S L	15.24	41.28	-	15.24	25.40	B33-133-461	i3300	B30-R4300	1500
▲	B-492	F N H L	25.40	12.70	-	-	-	B33-59-492	i3300	B30-R6400	2500
2.0 - 4.0 ml											
▷	B-461	F N A H S L	15.24	48.26	-	15.24	40.00	B33-638-461	i3300	B30-R4300	2000
4.0 - 8.0 ml											
●	B-499	F N A	25.40	66.68	-	-	-	B33-625-499	i3300	B30-R6000HF	1500
4.0 - 50.0 ml											
▷	B-461	F N A H S L	34.93	45.72	-	34.93	40.00	B33-632-461	i3300	B30-R4300	1500
12.0 - 24.0 ml											
●	B-498	F R	12.70	36.50	-	-	-	B33-87-498	i3300	B30-R6200	2500
12.0 - 50.0 ml											
▷	B-461	F N A H S L	25.40	133.35	-	25.40	38.10	B33-139-461	i3300	B30-R4300	650

>>

F Freezer environment **N** Liquid nitrogen environment **A** Autoclave environment **H** Hot water bath (100°C) **S** Self-laminating label **L** Low-profile (extremely thin) label **R** Removable

B-461, B-490, B-492, B-498 & B-499 Vial & tube labels (Continued)

Always have clear, legible specimen samples



Diagram	Material	Special Properties	Label Width A (mm)	Label Height B (mm)	Label Length B (m)	Print-able Area Width (mm)	Print-able Area PW (mm)	Print-able Area Height PH (mm)	Order Reference	Printer Compatibility	Printer Ribbon Series	Labels per Roll
14.0 - 15.0 ml												
▲	B-490	F N H L	55.88	38.10	-	-	-	-	B33-157-490		B30-R4300	1000
15.0 - 50.0 ml												
●	B-499	F N A	12.70	25.40	-	-	-	-	B33-611-499	i3300	B30-R6000HF	3000
▲	B-499	F N A	25.40	12.40	-	-	-	-	B33-659-499	i3300	B30-R6000HF	1000
●	B-499	F N A	25.40	36.50	-	-	-	-	B33-621-499	i3300	B30-R6000HF	3000
●	B-498	F R	25.40	36.50	-	-	-	-	B33-89-498	i3300	B30-R6200	2300
▷	B-461	F N A H S L	25.40	66.68	-	25.40	25.40	-	B33-276-461	i3300	B30-R4300	1500
▷	B-461	F N A H S L	38.10	88.90	-	38.10	31.75	-	B33-134-461	i3300	B30-R4300	1000
50.0 ml												
▲	B-492	F N H L	22.86	25.40	-	-	-	-	B33-180-492	i3300	B30-R6400	1500
●	B-498	F R	25.40	12.70	-	-	-	-	B33-5-498	i3300	B30-R6200	5000
▲	B-492	F N H L	25.40	25.40	-	-	-	-	B33-179-492	i3300	B30-R6400	1900
▲	B-490	F N H L	50.80	6.35	-	-	-	-	B33-151-490	i3300	B30-R4300	2500

B-461, B-490 & B-492 Centrifuge, eppendorf & PCR tube labels

Stays put in harsh conditions and resist common laboratory chemicals

- Thin construction that prevents jamming in centrifuges and racks
- Long and short tails styles provide window for viewing liquids level in tube
- B-490 can be applied to frozen surfaces including glass and polypropylene stored in liquid nitrogen. Material must slightly overlap itself
- B-492 can be applied to frozen surfaces including glass and polypropylene stored in liquid nitrogen

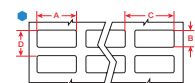
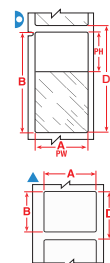

Diagram	Material	Special Properties	Label Width A (mm)	Label Height B (mm)	Label Length B (m)	Print-able Area Width (mm)	Print-able Area PW (mm)	Print-able Area Height PH (mm)	Order Reference	Printer Compatibility	Printer Ribbon Series	Labels per Roll
0.5 - 0.7 ml												
▷	B-461	F N A H S L	5.08	22.86	-	5.08	18.23	-	B33-614-461	i3300	B30-R4300	2000
▷	B-461	F N A H S L	9.53	19.05	-	9.53	19.05	-	B33-123-461	i3300	B30-R4300	1500
●	B-490	F N H L	12.70	19.05	-	-	-	-	B33-68-490	i3300	B30-R4300	2500
▷	B-461	F N A H S L	12.70	45.72	-	12.70	19.05	-	B33-122-461	i3300	B30-R4300	1500
▷	B-461	F N A H S L	12.70	55.88	-	12.70	19.05	-	B33-127-461	i3300	B30-R4300	1500
●	B-492	F N H L	25.40	9.53	-	-	-	-	B33-152-492	i3300	B30-R6400	2500
▲	B-490	F N H L	31.75	9.53	-	-	-	-	B33-154-490	i3300	B30-R4300	1500
0.5 ml												
▷	B-461	F N A H S L	6.35	27.94	-	6.35	22.00	-	B33-627-461	i3300	B30-R4300	1000
1.0 - 8.0 ml												
▷	B-461	F N A H S L	15.24	66.68	-	15.24	25.40	-	B33-153-461	i3300	B30-R4300	1500
▲	B-492	F N H L	41.28	15.24	-	-	-	-	B33-155-492	i3300	R6400	1500
▲	B-490	F N H L	41.28	15.24	-	-	-	-	B33-155-490	i3300	B30-R4300	1500



Laboratory identification



B-461, B-490, B-492 & B-499 Conical / Large tube labels

Use these labels for labelling larger tube sizes, while still providing the needed temperature and chemical resistance properties

- B-490 can be applied to frozen surfaces including glass and polypropylene stored in liquid nitrogen. Material must slightly overlap itself
- B-492 can be applied to frozen surfaces including glass and polypropylene stored in liquid nitrogen

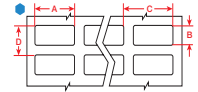
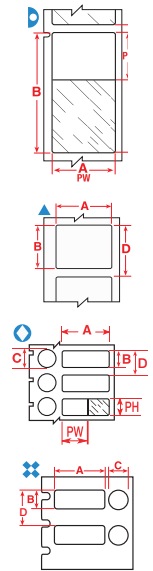

Diagram	Material	Special Properties	Label Width A (mm)	Label Height B (mm)	Label Length B (m)	Print-able Area Width PW (mm)	Print-able Area Height PH (mm)	Order Reference	Printer Compatibility	Printer Ribbon Series	Labels per Roll
0.5 - 0.7 ml											
◆	B-499	F N A	12.70	19.05	-	-	-	B33-68-499	i3300	B30-R6000HF	1500
▲	B-499	F N A	12.70	25.40	-	-	-	B33-620-499	i3300	B30-R6000HF	1000
▷	B-461	F N A H S L	12.70	55.88	-	12.70	19.05	B33-127-461	i3300	B30-R4300	1500
◆	B-499	F N A	25.40	9.53	-	-	-	B33-152-499	i3300	B30-R6000HF	1500
◆	B-492	F N H L	25.40	9.53	-	-	-	B33-152-492	i3300	B30-R6400	2500
0.6 ml											
▲	B-499	F N A	22.86	12.70	-	-	-	B33-125-499	i3300	B30-R6000HF	1500
1.0 - 2.0 ml											
▷	B-461	F N A H S L	15.24	38.10	-	15.24	33.03	B33-628-461	i3300	B30-R4300	2500
▷	B-461	F N A H S L	15.24	66.68	-	15.24	25.40	B33-612-461	i3300	B30-R4300	1500
◇	B-461	F A H S L	41.28	15.24	-	30.00	15.24	B33-608-461	i3300	B30-R4300	1000
1.0 - 8.0 ml											
⊕	B-499	F A	22.86	12.70	-	-	-	B33-126-499	i3300	B30-R6000HF	1500
⊕	B-492	F H L	41.28	15.24	-	-	-	B33-190-492	i3300	R6400	1500
▲	B-492	F N H L	41.28	15.24	-	-	-	B33-155-492	i3300	R6400	1500
▲	B-490	F N H L	41.28	15.24	-	-	-	B33-155-490	i3300	B30-R4300	1500
▲	B-492	F N H L	48.26	25.40	-	-	-	B33-156-492	i3300	B30-R6400	1500
1.5 - 2.0 ml											
▷	B-461	F N A H S L	15.24	41.28	-	15.24	25.40	B33-133-461	i3300	B30-R4300	1500
▲	B-492	F N H L	25.40	12.70	-	-	-	B33-59-492	i3300	B30-R6400	2500
2.0 - 4.0 ml											
▷	B-461	F N A H S L	15.24	48.26	-	15.24	40.00	B33-638-461	i3300	B30-R4300	2000
4.0 - 8.0 ml											
◆	B-499	F N A	25.40	66.68	-	-	-	B33-625-499	i3300	B30-R6000HF	1500
4.0 - 50.0 ml											
▷	B-461	F N A H S L	34.93	45.72	-	34.93	40.00	B33-632-461	i3300	B30-R4300	1500
12.0 - 50.0 ml											
▷	B-461	F N A H S L	25.40	133.35	-	25.40	38.10	B33-139-461	i3300	B30-R4300	650
15.0 - 50.0 ml											
◆	B-499	F N A	20.32	36.50	-	-	-	B33-165-499	i3300	B30-R6000HF	2500
◆	B-499	F N A	25.40	36.50	-	-	-	B33-621-499	i3300	B30-R6000HF	3000
▷	B-461	F N A H S L	25.40	66.68	-	25.40	25.40	B33-276-461	i3300	B30-R4300	1500
▷	B-461	F N A H S L	38.10	88.90	-	38.10	31.75	B33-134-461	i3300	B30-R4300	1000
▲	B-461	F N A H S L	48.26	25.40	-	48.26	25.40	B33-636-461AW	i3300	B30-R4300	2000
▲	B-461	F N A H L	57.15	19.05	-	57.15	19.05	B33-642-461AW	i3300	B30-R4300	2000
▲	B-461	F N A H S L	88.90	38.10	-	88.90	38.10	B33-650-461AW	i3300	B30-R4300	2000
50.0 ml											
▷	B-461	F N A H S L	19.05	38.10	-	19.05	33.02	B33-629-461	i3300	B30-R4300	2500
▲	B-492	F N H L	25.40	25.40	-	-	-	B33-179-492	i3300	B30-R6400	1900
▲	B-499	F N A	38.10	19.05	-	-	-	B33-136-499	i3300	B30-R6000HF	1500
▲	B-490	F N H L	50.80	6.35	-	-	-	B33-151-490	i3300	B30-R4300	2500
▲	B-499	F N A	50.80	25.40	-	-	-	B33-137-499	i3300	B30-R6000HF	1100
▲	B-490	F N H L	95.25	38.10	-	-	-	B33-158-490	i3300	B30-R4300	1000



*AW = All white / no transparent area

Laboratory identification



B-7425 Polypropylene labels (Continued)

Track almost any sample in the lab

Diagram	Material	Special Properties	Label Width A (mm)	Label Height B (mm)	Order Reference	Printer Compatibility	Printer Ribbon Series	Labels per Roll
50.0 ml								
▲	B-7425	F N A H	38.10	19.05	B33-136-7425	i3300	R6400	1500
⚡	B-7425	F N A H	50.80	6.35	B33-151-7425	i3300	R6400	2000
▲	B-7425	F N A H	50.80	25.40	B33-137-7425	i3300	R6400	1500
▲	B-7425	F N A H	38.10	25.40	B33-235-7425	i3300	R6400	1250
▲	B-7425	F N A H	44.45	38.10	B33-258-7425	i3300	R6400	900
▲	B-7425	F N A H	50.80	12.70	B33-53-7425	i3300	R6400	2000



B-7425-AC Sterilisation indicating labels

Label confirms successful sterilisation



Diagram	Material	Label Width A (mm)	Label Height B (mm)	Order Reference	Printer Compatibility	Printer Ribbon Series	Labels per Roll
50.0 ml							
▲	B-7425	50.80	25.40	B33-137-7425-AC	i3300	B30-R4300	1500
▲	B-7425	38.10	25.40	B33-235-7425-AC	i3300	B30-R4300	1250



B-488 Well plate labels

Our well plate labels guarantee crystal clear text and barcoding for most laboratory environments

- Chemically-resistant polyester made to fit common well plate sizes

Diagram	Material	Special Properties	Label Width A (mm)	Label Height B (mm)	Order Reference	Printer Compatibility	Printer Ribbon Series	Labels per Roll
●	B-488	F A	22.86	19.05	B33-616-488	i3300	B30-R4300	3000
●	B-488	F A	22.86	22.86	B33-617-488	i3300	B30-R4300	3000
▲	B-488	F A	48.26	6.35	B33-635-488	i3300	B30-R4300	2000



B-481 & B-488 Slide labels

Designed to provide crisp and clear sample identification throughout the sample generation, inspection and storage process

- Resistant to xylene, alcohol and DMSO

Diagram	Material	Special Properties	Label Width A (mm)	Label Height B (mm)	Order Reference	Printer Compatibility	Printer Ribbon Series	Labels per Roll
▲	B-481	F H	22.86	9.53	B33-195-481	i3300	B30-R6400	3000
●	B-488	F A	22.86	19.05	B33-616-488	i3300	B30-R4300	3000
▲	B-481	F H	22.86	19.05	B33-194-481	i3300	B30-R6400	2000
●	B-488	F A	22.86	22.86	B33-617-488	i3300	B30-R4300	3000
▲	B-481	F H	22.86	22.86	B33-141-481	i3300	B30-R6400	1500
▲	B-488	F A	48.26	6.35	B33-635-488	i3300	B30-R4300	2000

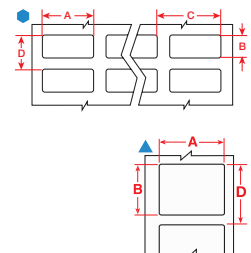

B-427 Straw labelling

These self-laminating labels protect the printed information for lasting identification

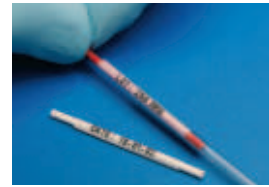
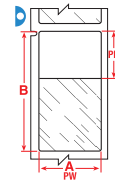

Diagram	Material	Special Properties	Label Width A (mm)	Label Height B (mm)	Label Length B (m)	Print-able Area Width PW (mm)	Print-able Area Height PH (mm)	Order Reference	Printer Compatibility	Printer Ribbon Series	Labels per Roll
0.5 ml											
▷	B-427	F N S	25.40	63.50	-	25.40	19.05	B33-511-427	i3300	B30-R4300	1500
0.3 ml											
▷	B-427	F N S	25.40	25.40	-	25.40	9.53	B33-211-427	i3300	B30-R4300	3000
▷	B-427	F N S	25.40	25.40	-	25.40	9.53	B33-116-427	i3300	B30-R4300	2500
▷	B-427	F N S	44.45	38.10	-	44.45	12.70	B33-121-427	i3300	B30-R4300	1000



B-482 Tissue cassette labels

Tissue cassette labels are used in conjunction with BSP31 Label Attachment System

- Superior resistance to processing fluids and conditions



Diagram	Material	Special Properties	Label Width A (mm)	Label Height B (mm)	Order Reference	Printer Compatibility	Printer Ribbon Series	Labels per Roll
▲	B-482	F H	26.67	6.35	B33-199-482	i3300	B30-R6400	3000
▲	B-482	F H	26.67	7.95	B33-213-482	i3300	B30-R6400	3000

Description	Order Reference
BSP31 Label Attachment System - EU/UK	BSP31 LABEL ATTACHMENT SYSTEM EUROPE

B-488 Bottles, flasks, dishes and general identification

Used to identify a variety of common laboratory glassware items and other consumables

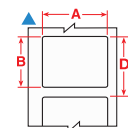
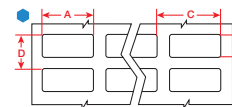

Diagram	Material	Special Properties	Label Width A (mm)	Label Height B (mm)	Order Reference	Printer Compatibility	Printer Ribbon Series	Labels per Roll
●	B-488	F A	22.86	19.05	B33-616-488	i3300	B30-R4300	3000
●	B-488	F A	22.86	22.86	B33-617-488	i3300	B30-R4300	3000
▲	B-488	F A	48.26	6.35	B33-635-488	i3300	B30-R4300	2000

B-403 Water dissolvable label

The label dissolves within 30 seconds exposure to water































































Diagram	Material	Special Properties	Label Width A (mm)	Label Height B (mm)	Label Length B (m)	Order Reference	Printer Compatibility	Printer Ribbon Series	Labels per Roll
∞	B-403	R	28.58	-	30.48	B30C-1125-403-WT	BBP35, BBP37, S3000, i3300, S3100	B30-R4300	1
∞	B-403	R	57.15	-	30.48	B30C-2250-403-WT	BBP35, BBP37, S3000, i3300, S3100	B30-R4300	1
∞	B-403	R	76.20	-	30.48	B30C-3000-403-WT	BBP35, BBP37, S3000, i3300, S3100	B30-R4300	1
∞	B-403	R	101.60	-	30.48	B30C-4000-403-WT	BBP35, BBP37, S3000, i3300, S3100	B30-R4300	1

Master material index

This section provides a quick reference to Brady materials listed throughout this catalogue, including basic attributes, applications and regulatory compliance where applicable.







For more detailed material attribute and performance information, please refer to the material's Technical Data Sheet, listed at www.bradyeurope.com/tds.

Brady Material No.	Material	Finish	Colour	Temp (°C) (Tested for 30 days)		Performance Attributes	Properties & Applications	Approval/Compliance
				Min.	Max.			
B-342	Heat-shrink Polyolefin Sleeve	Matt	White	-55 °C	130.6 °C		3:1 ratio heat shrinkable wire marking sleeve that fits snugly around wires for identification and protection. Fade-resistant and flame retardant. Also available in yellow and black.	UL Recognised to UL224; SAE-AMS-DTL-23053/5 C (Class 1); SAE-AS-81531
B-345	High Temperature Heat-shrink Polyvinylidene Fluoride Sleeve	Matt	White	-70 °C	130.6 °C		2:1 ratio heat shrinkable wire marking sleeve specifically designed for high temperature and low vacuum outgassing applications. These heat shrinkable wire marking sleeves are made from irradiated high temperature PVDF. Also available in black.	NASA SP-R-0022A Outgassing Performance; SAE-AMS-DTL-23053/18 (Class 2); SAE-AS-81531; MIL-STD-202G Method 215K
B-348	Polyolefin	Matt	White	-55 °C	135 °C		Mass Transit Tag complies with minimal smoke and halogen emission requirements of the most strict underground norms for mass transit vehicles. The tag is a practical solution for mass transit manufacturers to identify thick cables and cable bundles.	–
B-403	Paper	Matt	Black on White	-40 °C	78 °C		White dissolvable paper. Dissolves completely in water leaving no adhesive residue, ideal for temporary labelling applications	–
 B-422	Polyester	Gloss	White	-40 °C	100 °C	     	White material stock with glossy finish and 2 mils of adhesive for rough surface applications, including low surface energy plastics. Designed to withstand solvent exposure. UL rated for surfaces commonly used in solar panel manufacturing. Also used for component identification, barcoding, asset and inventory tracking.	UL Recognised; CSA Accepted
 B-423	Polyester	Gloss	White	-70 °C	110 °C	     	White polyester thermal transfer printable material with a glossy finish. Widely used for component identification, barcoding, asset and inventory tracking. UL rated for surfaces commonly used in solar panel manufacturing.	UL Recognised; CSA Accepted; AGA Approved; Halogen Free (DIN VDE 0472/part 815)
B-424	Paper	Matt	White	-40 °C	50 °C		White paper material with matt finish and smooth top coat finish for thermal transfer printing. Good contrast and smear resistance for thermal barcode printing. Used for general purpose labeling applications	–
 B-425A	Polypropylene	Matt	White	-70 °C	80 °C	  	White polypropylene material stock with matt finish for thermal transfer printing or write-on applications. Excellent solvent resistance and print performance; not recommended for long-term outdoor use.	UL Recognised; CSA Accepted; Halogen Free (DIN VDE 0472/part 815)
B-427	Self-laminating Vinyl	Matt	White/Transparent	-40 °C	60 °C		Thermal transfer printable, self-laminating material. These labels have a printable area with a clear "tail" that wraps around the marker. The "tail" serves as overlaminates to protect the print. Superior resistance to abrasion, solvents, water, oil and dirt. Also available in grey, brown, green, yellow, blue, red, purple, orange	UL Recognised to UL969 Labelling and Marking Standard when printed with the Brady Series R4300 and R6200 ribbons. See UL files MH17154 for specific details. Brady customers should specify at purchase if they require UL Recognised B-427 labels. Brady sells both UL Recognised B-427 labels and non-approved labels depending on customer requirements.
 B-428	Metallised Polyester	Matt	Silver	-70 °C	120 °C	     	Thermal transfer printable metallised polyester with matt finish. Withstands solvents and variable temperatures. Excellent for serial and rating plate applications with name-plate quality and a metal-looking finish.	UL Recognised; CSA Accepted; Halogen Free (DIN VDE 0472/part 815)
 B-430	Polyester	Gloss	Clear	-70 °C	100 °C	     	Translucent, high performance polyester material with a glossy finish. Thermal transfer printable.	UL Recognised; CSA Accepted
 B-432	Polyester	Gloss	Clear	-40 °C	100 °C	     	Translucent, high performance polyester material with a glossy finish. Thermal transfer printable. Very similar to B-430, but has a thicker layer of acrylic adhesive for better adherence to rough surface applications.	UL Recognised; CSA Accepted
 B-434	Metallised Polyester	Gloss	Silver	-40 °C	90 °C	     	Metallised polyester with a glossy finish and a thicker layer of adhesive for better adherence to rough surface applications. Withstands numerous solvents while maintaining excellent image quality.	UL Recognised; CSA Accepted

Brady Material No.	Material	Finish	Colour	Temp (°C) (Tested for 30 days)		Performance Attributes	Properties & Applications	Approval/Compliance
				Min.	Max.			
 B-435	Metallised Polyester	Gloss	Silver	-40 °C	90 °C		Printable metallised polyester withstands numerous solvents and variable temperatures. Ideal for serial and rating plate applications with name-plate quality and a metal looking finish.	UL Recognised; CSA Accepted
B-437	Polyvinylfluoride	Matt	White	-70 °C	135 °C		Polyvinylfluoride label material with matt finish. Used in wire and cable identification applications where self-extinguishing features are required. This label material utilises an adhesive for heavy-duty applications and is available in continuous or die-cut formats. Excellent resistance to water, oil and other common fluids. Also available in yellow.	MIL-M-87958 Pressure Sensitive Adhesive Wire or Cable Marker and Identification specification
 B-438	Tamper-evident Metallised Polyester	Matt	Silver	-40 °C	40 °C		Metallised polyester material with matt finish. Leaves a checkerboard footprint on the surface when removed; the pattern also appears on the top of the label to prevent it from being reused.	UL Recognised
B-461	Self-laminating Polyester	Matt	White/ Transparent	-196 °C	110 °C		Permanent adhesive; suitable for liquid nitrogen application if material is wrapped around itself, as in self-lamination; write-on capabilities. Temperature range increases to 121 °C when used in autoclave process	–
B-472	Polyimide	Matt	White	-70 °C	100 °C		Cable and wire bundle applications and label applications where self-extinguishing properties are required	–
B-480A	Metallic, Non-metal Polyester	Satin	Silver	-70 °C	110 °C			UL Recognised; cUL Recognised
B-481	StainerBondz™ Polyester	Matt	White	-80 °C	130 °C		White polyester will remain resistant when exposed to xylene and other chemicals that are commonly used in the slide staining process	–
B-482	Polyester	Matt	White				The B-482 label material, combined with Brady's R6400 ribbon, provides the durability and print quality that histology and anatomic pathology labs need for accurate, identifiable specimen labelling. Paraffin and solvent resistant.	–
 B-483	Polyester	Gloss	White	-40 °C	120 °C		White polyester thermal transfer printable material with glossy finish and aggressive adhesive specifically designed for powder coated surfaces.	UL Recognised; CSA Accepted
 B-484A	Polyester	Gloss	White	-40 °C	120 °C		White polyester thermal transfer printable material, similar to B-483, but with thinner construction for curved or angled surfaces. Offers aggressive adhesive for adhesion to textured metals and low surface energy plastics.	UL Recognised
 B-486B	Metallised Polyester	Matt	Silver	-40 °C	120 °C		Thermal transfer printable metallised polyester material. Designed for high adhesion to textured metals, powder coated surfaces and low surface energy plastics.	UL Recognised; CSA Accepted
 B-488	Polyester	Matt	White	-40 °C	145 °C		White polyester thermal transfer printable material, similar to B-423, but with matt finish. Widely used for component identification, barcoding, asset and inventory tracking.	UL Recognised; CSA Accepted
B-489A	Polyester	Matt	White	-40 °C	120 °C			UL Recognised; CSA Accepted
B-490	Freezerbondz™ Polyester	Matt	White	-196 °C	130 °C		Can be applied to frozen surfaces including glass and polypropylene stored in liquid nitrogen, except for Vial Tops. Material must slightly overlap itself.	–
B-492	Freezerbondz™ Polyester	Matt	White	-196 °C	110 °C		Ultra thin; can label frosted/frozen (with overlap) or room temperature labels and lasts in liquid nitrogen and hot water baths	–
 B-498	Vinyl Cloth	Semi-gloss	White	-40 °C	80 °C		White vinyl cloth label material with glossy finish. The adhesive and cloth backing give excellent holding power, while being repositionable and removing cleanly.	UL Recognised
B-499	Nylon Cloth	Matt	White	-40 °C	90 °C		Nylon cloth material with matt finish. The adhesive allows labelling in environments with heat, cold, oil and dirt. Also available in yellow.	UL Recognised; CSA Accepted; Halogen Free (DIN VDE 0472/ part 815) Approvals are for White material only
B-509	Magnetic Polyester		White	-18 °C	70 °C		Magnetic Back Polyester is used for temporary, reusable and movable signs	–
B-526	Phosphorescent Polyester	Gloss	Luminous Green	-40 °C	60 °C		BradyGlo™ High Intensity laminate is designed to provide high adhesion and luminance for egress marking in low light areas in and along stairwells of public buildings, exit and directional signs, identification of fire alarms and extinguishers, low location egress pathway markings, and directional systems for escape or evacuation routes.	New York Local Law 26 RS 6-1 & 6-1A; City of New York, Department of Buildings MEA No. 467-06-M UV: 46-9-7

Master material index

Brady Material No.	Material	Finish	Colour	Temp (°C) (Tested for 30 days)		Performance Attributes	Properties & Applications	Approval/Compliance
				Min.	Max.			
B-549	Polyester	Gloss	White	-40 °C	100 °C		Flexible, dimensionally stable, low temperature, pressure sensitive adhesive tape for permanent application. Adhesive can be applied at temperatures down to -10°F (-23°C).	–
B-551	Polyester Tag		White	-40 °C	89 °C		Tag material used for marking on-the-spot warning of dangerous conditions	Complies to OSHA 1910.145(f) when printed with required signal word and major message.
B-565	Metallised Polyester	Matt	Silver	-40 °C	110 °C		Designed for applications like identification labels or rating and serial plates that utilise barcodes, alphanumerics, graphic symbols and logos and require nameplate-like quality	–
B-569	Polyester		Green	-40 °C	100 °C		Designed for use on stainless steel pipes in harsh environments such as the Pulp and Paper Industry	–
B-581	Vinyl	Gloss	White	-40 °C	82 °C		Only indoor use, where frequent repositioning is required	–
B-584	Reflective Tape	Gloss	Orange	-40 °C	70 °C		Suitable for outdoor use. Also available in silver and yellow.	–
B-593	Polyester	Gloss	White	-20 °C	100 °C		EPREP (Engraved Panel REplacement labels) are designed for patch panel identification in identifying external push-buttons, switches and internal connection points. Also available in black, green, red, silver and yellow.	UL Recognised; cUL Recognised
B-595	Vinyl	Gloss	White	-40 °C	82 °C		Durable, low-shrink vinyl with our most aggressive adhesive. Conforms to irregular, curved, rough and highly textured surfaces (painted cinder blocks, uneven wood, textured plastics, paper-jacketed pipes, powder-coated surfaces). Adheres to "difficult" low-surface energy items (PVC piping, blow-moulded equipment cases, ABS plastics, recycled plastics). Available in a wide range of colours.	BS5609:1986 Section 2 and section 3
B-717	Polyimide	Gloss	White	-70 °C	300 °C		White polyimide material with glossy finish and ultra-durable adhesive. Used in printed circuit board and electronic component pre-process labelling. Designed for use with extreme wash protocol and cleaning chemicals. Surface resistivity values in the recommended range for dissipative ESD packing materials.	UL Recognised; Meets the requirements of ANSI/ESD S541-2008 (between 10 ⁴ and 10 ¹¹ ohms) for dissipative ESD packaging materials; Meets the performance requirements of MIL-STD-202G, Method 215K
B-718	Polyimide	Gloss	White	-70 °C	300 °C		White polyimide material, low profile (1 mil thickness), with glossy finish and ultra-durable adhesive. Used in printed circuit board and electronic component pre-process labelling. Designed for use with extreme wash protocol and cleaning chemicals. Surface resistivity values in the recommended range for dissipative ESD packing materials.	UL Recognised; Meets the requirements of ANSI/ESD S541-2008 (between 10 ⁴ and 10 ¹¹ ohms) for dissipative ESD packaging materials; Meets the performance requirements of MIL-STD-202G, Method 215K
B-719	Polyimide	Matt	White	-70 °C	300 °C		White polyimide material with matt finish and ultra-durable adhesive. Used in printed circuit board and electronic component pre-process labelling. Designed for use with extreme wash protocol and cleaning chemicals. Surface resistivity values in the recommended range for dissipative ESD packing materials.	UL Recognised; Meets the requirements of ANSI/ESD S541-2008 (between 10 ⁴ and 10 ¹¹ ohms) for dissipative ESD packaging materials; Meets the performance requirements of MIL-STD-202G, Method 215K
B-724	Polyimide	Matt	Amber	-70 °C	300 °C		Amber polyimide material with matt finish and ultra-durable adhesive. Used in printed circuit board and electronic component pre-process labelling. Designed for use with extreme wash protocol and cleaning chemicals.	Meets the performance requirements of MIL -STD-202G, Notice 12, Method 215K; Meets the requirements of SAE AS81531 Marking of Electrical Insulating Material
B-727	Polyimide	Gloss	White	-70 °C	300 °C		White polyimide material with glossy finish and ultra-durable adhesive. Used in printed circuit board and electronic component pre-process labelling. Designed for use with extreme wash protocol and cleaning chemicals.	UL Recognised; Meets the performance requirements of MIL -STD-202G, Notice 12, Method 215K; Dibutyltin and Dioctyltin free.
B-7425	Polypropylene	Matt	Black on White	-80 °C	70 °C		White Polypropylene material. Ideal for laboratory identification such as vials, centrifuge tubes and test tubes. For freezer or liquid nitrogen applications, B-7425 must be applied prior to being frozen.	–
B-7563	Metallised Polyester	Satin	Silver	-40 °C	135 °C		Thermal transfer printable metallised polyester withstands numerous solvents and variable temperatures. Ideal for serial and rating plate applications with name-plate quality and a metal looking finish.	UL Recognised
B-7569	Vinyl	Gloss	White	-20 °C	75 °C		Used for Pipe Markers, Arrow Tape, Warehouse Marking, Floor Marking, Warning Panels, Safety Signs and Hazardous Substance Identification. Available in a wide range of colours.	BS5609:1986 Section 2 and section 3

Brady Material No.	Material	Finish	Colour	Temp (°C) (Tested for 30 days)		Performance Attributes	Properties & Applications	Approval/Compliance
				Min.	Max.			
B-7597	Polyethylene Tag	Matt	White	-40 °C	100 °C		Polyethylene tag material. Resists tearing and the topcoat resists smudging and abrasion. Halogen free material.	Halogen Free (DIN VDE 0472/ part 815)
B-7598	Polyester Tag	Gloss	White, Yellow, Red, Green, Silver, Black, Blue	-40 °C	100 °C		A general identification polyester tag for cables exposed to extreme conditions. Up to 10 years outdoor durability. Also available in black, blue, green, red, silver and yellow.	Parts supplied in White, Black or Silver are Halogen Free as per IEC 61249-2-21 (2003-11)
B-7599	Polyethylene Tag	Matt	Yellow	-40 °C	50 °C			—
B-7641	Heat-shrink Polyolefin Sleeve	Matt	White	-55 °C	105 °C		2:1 ratio heat shrinkable, zero halogen wire marking sleeves. The wire marking sleeves offer outstanding fire safety properties and minimal smoke emission. Also available in yellow.	BS-6853 (1999) Vehicle Category 1A; EN-45545-2, requirement 24, Vehicle Category HL3; Zero Halogen
B-7642	Heat-shrink Polyolefin Sleeve	Matt	White	-40 °C	120 °C	  	2:1 ratio heat shrinkable wire marking sleeves. The sleeves are high-temperature rated, highly flame retardant, and very flexible.	UL 224; SAE-AMS-DTL-23053/5 (Class 1 and 3); SAE-AS-81531; MIL-STD-202 method 215K; Tested per ASTM E162; ASTM E662
B-7643	Thermoplastic Polyether Polyurethane	Matt	White, Yellow	-40 °C	90 °C		Thermal transfer and dot matrix printable wire and cable bundle tag for harsh environments. Low halogen material. Also available in black, orange, red and yellow.	Halogen free per IEC 61249-2-21 (2003-11), Adherence: SAE-AS81531-1998, Flame retardant: MIL-STD-202G
B-7696	Vinyl Tag	Gloss	White, Yellow	-40 °C	70 °C			UL94V0
B-8423	Polyester	Satin	White	-70 °C	110 °C	  	Polyester material with satin finish, economical alternative to B-423. Used for component identification, barcoding, asset and inventory tracking. Also available in yellow.	UL Recognised; CSA Accepted
B-854	Metal Detectable Polyester	Matt	White	-40 °C	110 °C		Tough against harsh washdown environments; metal detectable. Also available in yellow.	—
B-855	Polyester	Matt	White	-40 °C	110 °C		Tough against harsh washdown environments. Also available in yellow.	—

Product performance icons

Brady's implementation of a series of attribute icons provides customers with at-a-glance information on performance attributes for each of the label materials. They will help you to easily identify product performance features that fit your needs.



Abrasion Resistance

- Resistance proven with testing on Taber Abraser equipment with CS10 grinding wheels and weighted arms.

Electrostatic Dissipative



- Indicated material has surface resistivity values in the recommended range for Dissipative ESD Packaging Materials.

Low Temperature Resistance



- Labels subjected to -40°C, -70°C or -80°C for 30 days or 1000 hours.

Self-extinguishing Anti-flammability



- Flammability average burn time = <30 seconds
- Flame spread index of 0

Temperature-indicating



- Indicates highest temperature exposure

Fuel/Oil Resistance



- Resistance proven with Immersion Test in Gasoline, Break Fluid, SAE 30wt Oil, JP-8 Jet Fuel, MIL-H- 5606 Oil.

Outdoor Durability



- Favourable UV & weatherability testing equating to 3 years or greater outdoor durability.

Solvent/Chemical Resistance



- Resistance proven with MEK / Acetone / Toluene / Xylene Immersion Test

Ultra-aggressive Adhesion



- Measures the force required to remove label from the surface with a 180° peel and a constant rate of 12 inch/min.

High Heat Resistance



- Resistance to 100°C.

Removable



- Indicates material can be removed cleanly with no adhesive residue left on surface.

Tamper-indicating



- Materials indicate tampering through a visible fractured label or footprint.















Water-indicating









- Indicates presence of liquid

Master material index

Material Brands & Attributes

	 WorkHorse™ Labels	 MetaLabel™ Series	 ToughBond™ Series	 Defender™ Series	 CleanLift™ Series	 UltraTemp™ Series
 Abrasion Resistance	✓	✓	✓	✓	✓	✓
 Electrostatic Dissipative	✓	-	-	-	-	✓
 Fuel/Oil Resistance	✓	✓	✓	✓	✓	✓
 High Heat Resistance	✓	✓	✓	✓	✓	✓
 Low Temperature Resistance	✓	✓	✓	✓	✓	✓
 Removable	-	-	-	-	✓	-
 Solvent/Chemical Resistance	✓	✓	✓	✓	✓	✓
 Tamper-indicating	-	-	-	✓	-	-
 Ultra-aggressive Adhesion	-	✓	✓	-	-	-

Recommended Material Applications

	 WorkHorse™ Labels	 MetaLabel™ Series	 ToughBond™ Series	 Defender™ Series	 CleanLift™ Series	 UltraTemp™ Series
UL / CSA	✓	✓	✓	✓	✓	✓
Component / Equipment ID	✓	✓	✓	✓	✓	-
Barcode / Data-coding	✓	✓	✓	-	✓	✓
Inventory Tracking	✓	-	✓	-	✓	-
Asset Tracking	✓	✓	✓	✓	✓	✓
Rating Plate	✓	✓	✓	-	✓	-
General ID	✓	-	✓	-	✓	-
Over-laminate	✓	-	✓	-	✓	-
Ultra-aggressive Adhesive	-	✓	✓	-	-	-
Circuit Board ID / High Temperature	✓	-	-	-	✓	✓
Tamper-indicating	-	-	-	✓	-	-
DoD UID*	-	-	✓	-	-	✓

*The Department of Defense Unique Identification program (DoD UID) is the asset tracking method used to manage inventory in the Defense Supply Chain.



Need More Information? View the technical data sheets Brady offers online access to technical data sheets for all Brady materials. View by a specific B-Number or search by relevant keywords.

Visit www.bradyeurope.com/tds or click the QR code.



BradyPrinter i3300 specifications

PRINTER	
Description	BradyPrinter i3300 Industrial Label Printer
Includes	This i3300 printer comes in a cardboard box. It ships with a power cord, a Brady Workstation Suite, a USB cable, a product CD holding the manual, a cleaning kit and a printed quick start guide
Applications	General & Industrial Identification; Circuit Board & Component Identification; Wire & Cable Marking; Laboratory Identification; Asset Identification; Workplace Safety & Compliance; Lean; 5S & Visual Workplace; Facility; Maintenance & Operations ID; Buildings & Grounds; Logistics/Warehousing
Print Speed (mm/sec)	101.60
Print Resolution (dpi)	300
Stand-alone Printing (Detached from PC)	Peripheral
Internal Memory	512 MB (RAM) - 195 MB (data storage)
Colour Capability	Monocolour
Language Support	Bulgarian, Czech, Danish, Dutch, English, Estonian, Finnish, French, German, Hungarian, Italian, Norwegian (Bokmål), Polish, Portuguese, Romanian, Russian, Slovak, Slovenian, Spanish, Swedish, Turkish, Croatian
Weight (kg)	5.30 kg
Size W x H x D (mm)	240 x 317 x 435
Calibration	Automated through Smart Cell
Operating Temperature	10°C - 40°C
Storage Humidity	15%-90% (non-condensing)
Warranty	1 year

MEDIA	
Materials Supported	Freezerbondz Polyester; Heat-shrink Polyolefin Sleeve; High Temperature Heat-shrink Polyvinylidene Fluoride Sleeve; Magnetic Polyester; Metal Detectable Polyester; Metallic, Non-metal Polyester; Metallised Polyester; Nylon Cloth; Paper; Phosphorescent Polyester; Polyester; Polyester Tag; Polyester with Polyester Overlaminates; Polyethylene Tag; Polyimide; Polyolefin; Polypropylene; Polyvinylfluoride; Reflective Tape; Self-laminating Polyester; Self-laminating Vinyl; StainerBondz Polyester; Tamper-evident Metallised Polyester; Thermoplastic Polyether Polyurethane; Vinyl; Vinyl Cloth
Label/Media Format	Media & Ribbon, supplied separately
Continuous vs Die-cut Labels	Continuous Tape & Die Cut Labels
Compatible Media	B30-, B30C-, B30EP-, B33-, B33C-, B33D-, B33FP-, B33FT-, B33R-
Number of stock	800+ standard parts
Max. Label Width (mm)	107.95
Min. Label Height (mm)	6.35
Min. Label Width (mm)	6.35
Max. Liner Width (mm)	107.95
Min. Liner Width (mm)	18
Max. Print Width (mm)	101.60
Recommended Usage per Day	1000

POWER SUPPLY	
Power Supply	AC Adaptor
Power Supply Voltage	110-240V

DISPLAY	
Display	Colour LCD Touchscreen
Display Resolution	272 x 480 px
On Screen Indicators	Supply Remaining, Ribbon Remaining, Ribbon and label part number recognition, WiFi, Ethernet Status, Error Messaging, Data Reception

SOFTWARE & CONNECTIVITY	
Connectivity Options	USB, Ethernet. Optional: WiFi (factory installed)
Software Compatibility	Brady Workstation, Windows based driver for 3rd party software use

FONTS/GRAPHICS/SYMBOLOLOGIES	
Built-in Fonts	Arial Courier New Times New Roman Treichuchet MS Verdana Tahoma
Bar Code Capability	Yes
Bar Code Type	Code 39, Code 93, Code 128 A, B, C, EAN-8, EAN-13, EAN/JAN 13, JAN-8, JAN-13, HIBC, Interleaved 2 of 5, Interleaved 2 of 5 w check digit, UPC A, Aztec, QR Code, datamatrix
Programming Language	BPL - scripting commands for sending scripts to the printer

COMPLIANCE	
Approval/Compliance	UL, cUL, CE, RoHS, RCM, KCC, EAC



Learn more about the BradyPrinter i3300 on :

www.bradyeurope.com/i3300

Printer

Article No.	Order Ref.	Description
with Wifi		
149554	i3300-300-C-EU-WF	i3300 Industrial Label Printer with Wifi- EU
241131	i3300-300-C-EU-W-LABS	i3300 Industrial Label Printer with Wifi- EU with Brady Workstation LAB Suite
241125	i3300-300-C-EU-W-PWID	i3300 Industrial Label Printer with Wifi- EU with Brady Workstation PWID Suite
241119	i3300-300-C-EU-W-SFIDS	i3300 Industrial Label Printer with Wifi- EU with Brady Workstation SFID Suite
149556	i3300-300-C-UK-WF	i3300 Industrial Label Printer with Wifi- UK
241133	i3300-300-C-UK-W-LABS	i3300 Industrial Label Printer with Wifi- UK with Brady Workstation LAB Suite
241127	i3300-300-C-UK-W-PWID	i3300 Industrial Label Printer with Wifi- UK with Brady Workstation PWID Suite
241121	i3300-300-C-UK-W-SFIDS	i3300 Industrial Label Printer with Wifi- UK with Brady Workstation SFID Suite
149552	i3300-300-C-US-WF	i3300 Industrial Label Printer with Wifi- US
241129	i3300-300-C-US-W-LABS	i3300 Industrial Label Printer with Wifi- US with Brady Workstation LAB Suite
241123	i3300-300-C-US-W-PWID	i3300 Industrial Label Printer with Wifi- US with Brady Workstation PWID Suite
241117	i3300-300-C-US-W-SFIDS	i3300 Industrial Label Printer with Wifi- US with Brady Workstation SFID Suite
without Wifi		
149553	i3300-300-C-EU	i3300 Industrial Label Printer- EU
241130	i3300-300-C-EU-LABS	i3300 Industrial Label Printer- EU with Brady Workstation LAB Suite
241124	i3300-300-C-EU-PWID	i3300 Industrial Label Printer- EU with Brady Workstation PWID Suite
241118	i3300-300-C-EU-SFIDS	i3300 Industrial Label Printer- EU with Brady Workstation SFID Suite
149555	i3300-300-C-UK	i3300 Industrial Label Printer- UK
241132	i3300-300-C-UK-LABS	i3300 Industrial Label Printer- UK with Brady Workstation LAB Suite
241126	i3300-300-C-UK-PWID	i3300 Industrial Label Printer- UK with Brady Workstation PWID Suite
241120	i3300-300-C-UK-SFIDS	i3300 Industrial Label Printer- UK with Brady Workstation SFID Suite
149551	i3300-300-C-US	i3300 Industrial Label Printer- US
241128	i3300-300-C-US-LABS	i3300 Industrial Label Printer- US with Brady Workstation LAB Suite
241122	i3300-300-C-US-PWID	i3300 Industrial Label Printer- US with Brady Workstation PWID Suite
241116	i3300-300-C-US-SFIDS	i3300 Industrial Label Printer- US with Brady Workstation SFID Suite



This i3300 printer comes in a cardboard box. It ships with a power cord, a Brady Workstation Suite, a USB cable, a product CD holding the manual, a cleaning kit and a printed quick start guide.

Accessories

Article No.	Order Ref.	Description
036612	Squeegee	Squeegee
120994	B30-TROLLEY	Trolley for BBP3x/S3xxx/i3300
133251	PCK-6	Printer Cleaning Kit - Thermal Transfer Printers
142114	B30-WIPER	Media Wiper 5 Pack for BBP30/S3000/BBP31/S3100/BBP33/i3300 Printers
142115	STYLUS PENS	Replacement Stylus 3 Pack
142116	B30-CCT	Cutter Cleaning Tool for BBP30, BBP31, BBP33, S3000, S3100 & i3300 printer



120994



036612



142116



142114



133251



142115

Printer kits

Article No.	Order Ref.	Description
199986	B30-FLOOR-KIT	Floor marking kit for BBP35/BBP37/S3xxx/i3300 printers
195963	B30-SAFETY-KIT	General safety kit for BBP3x Printers
195962	B30-PM-KIT	Pipe marking kit for BBP3x Printers
195961	B30-CLP-KIT	Pre-printed GHS/CLP Chemical Labels kit for BBP3x Printers



199986



195962

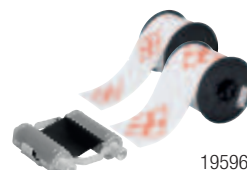

195961



195963

Africa

Randburg, South Africa
 Tel.: +27 11 704 3295
 Email: africa@bradycorp.com

Benelux

Zele, Belgium
 Tel.: +32 (0) 52 45 78 11
 Email: benelux@bradycorp.com

Central & Eastern Europe

Bratislava, Slovakia
 Tel.: +421 2 3300 4800
 Email: central_europe@bradycorp.com

Denmark

Odense
 Tel.: +45 66 14 44 00
 Email: denmark@bradycorp.com

France

Roncq
 Tel.: +33 (0) 3 20 76 94 48
 Email: france@bradycorp.com

Germany, Austria & Switzerland

Egelsbach, Germany
 Tel.: +49 (0) 6103 7598 660
 Email: germany@bradycorp.com

Hungary

Budaörs
 Tel.: +36 23 500 275
 Email: central_europe@bradycorp.com

Italy

Gorgonzola
 Tel.: +39 02 26 00 00 22
 Email: italy@bradycorp.com

Middle East FZE

Dubai, UAE
 Tel.: +971 4881 2524
 Email: me@bradycorp.com

Norway

Kjeller
 Tel.: +47 70 13 40 00
 Email: norway@bradycorp.com

Romania

Bucharest
 Tel.: +40 21 202 3032
 Email: central_europe@bradycorp.com

Russia

Moscow
 Tel.: +7 495 269 47 87
 Email: central_europe@bradycorp.com

Spain & Portugal

Madrid, Spain
 Tel.: +34 900 902 993
 Email: spain@bradycorp.com,
 portugal@bradycorp.com

Sweden, Finland, Baltic states

Kista, Sweden
 Tel.: +46 (0) 8 590 057 30
 Email: sweden@bradyeurope.com

Turkey

Istanbul
 Tel.: +90 212 264 02 20 / 264 02 21
 Email: turkey@bradycorp.com

UK & Ireland

Banbury, UK
 Tel.: +44 (0) 1295 228 288
 Email: uk@bradycorp.com

Our mission is to identify and protect people, products and places



To help minimise our impact on the environment, Brady limits its number of reprints.

Updated versions are always available for download on www.bradyeurope.com.

 Search for: EUR-M-055-EN



Y4822185

Your distributor



Omser (Scotland) Ltd
 incorporating Touch Print
 School Road, Gartocharn
 By Alexandria, G83 8RT
 T: 01389 830 408 F: 01389 830 349
sales@omser.co.uk www.omser.co.uk

31-07-2020